

WINNEBAGOTM

2017 Paint Codes

Contents

How To Use This Guide	4	Vista – Full Body Paint Option Code 24B/Spiral Gray	28
Minnie Winnie.....	5	Vista – Full Body Paint Option Code 24C/Cayenne.....	29
Fuse.....	6	Vista – Full Body Paint Option Code 27A/Cream.....	30
View	7	Vista – Full Body Paint Option Code 92A/Arctic Silver	31
View – Full Body Paint Option Code 24B/Bay Mist	8	Via – Full Body Paint Option Code 27A/Charcoal Bronze.....	33
View – Full Body Paint Option Code 24C/Pumpkin Spice.....	9	Via – Full Body Paint Option Code 92A/Stormy Gray	34
View – Full Body Paint Option Code 24H/Iris	10	Adventurer – Full Body Paint Option Code 24B/Black Walnut.....	35
View – Full Body Paint Option Code 24L/Beechwood.....	11	Adventurer – Full Body Paint Option Code 24C/Amber	36
View – Full Body Paint Option Code 27A/Coffee.....	12	Adventurer – Full Body Paint Option Code 27A/Pewter Pearl	37
View – Full Body Paint Option Code 92A/Tuscan Sun	13	Adventurer – Full Body Paint Option Code 92A/Sapphire.....	38
Trend.....	14	Adventurer – Full Body Paint Option Code 24L/Titanium	39
Aspect.....	15	Adventurer – Full Body Paint Option Code 24H/Sandstone.....	40
Aspect – Full Body Paint Option Code 24B/Garnet	16	Forza – Full Body Paint Option Code 24B/Pewter	41
Aspect – Full Body Paint Option Code 24C/Silver Smoke.....	17	Forza – Full Body Paint Option Code 24C/Mahogany	42
Aspect – Full Body Paint Option Code 27A/Windveil	18	Forza – Full Body Paint Option Code 27A/Sandstone.....	43
Aspect – Full Body Paint Option Code 92A/Crimson	19	Forza – Full Body Paint Option Code 92A/Red Maple	44
Brave	20	Forza – Full Body Paint Option Code 24H/Silver Pearl	45
Brave – Full Body Paint Option Code 27A/Daytona	22	Forza – Full Body Paint Option Code 24L/Silver Sky.....	46
Sightseer – Full Body Paint Option Code 24B/Ember.....	23	Journey – Full Body Paint Option Code 24B/Gray Mica	47
Sightseer – Full Body Paint Option Code 24C/Black Garnet.....	24	Journey – Full Body Paint Option Code 24C/Iron Gray.....	48
Sightseer – Full Body Paint Option Code 27A/Cloud	25	Journey – Full Body Paint Option Code 24H/Creamy Vanilla	49
Sightseer – Full Body Paint Option Code 92A/Cream.....	26	Journey – Full Body Paint Option Code 24L/Desert Canyon	50
Vista.....	27	Journey – Full Body Paint Option Code 27A/Light Sandalwood.....	51

Winnebago Industries Service Publications – 2017 W1 Winnebago Paint Codes

Journey – Full Body Paint Option Code 92A/Paprika	52	Grand Tour – Full Body Paint Option Code 24M/Solar Sand.....	65
Tour – Full Body Paint Option Code 95C/Spiral Gray	53	Grand Tour – Full Body Paint Option Code 27A/Solar Winds.....	66
Tour – Full Body Paint Option Code 95E/Platinum.....	54	Grand Tour – Full Body Paint Option Code 92A/Solar Stone	67
Tour – Full Body Paint Option Code 95F/Shiraz.....	55	Grand Tour – Full Body Paint Option Code 95C/Beachwood	68
Tour – Full Body Paint Option Code 95G/Autumn Frost	56	Grand Tour – Full Body Paint Option Code 95E/Spiral Gray.....	69
Tour – Full Body Paint Option Code 95H/Silver Birch.....	57	Grand Tour – Full Body Paint Option Code 95F/Merlot	70
Tour – Full Body Paint Option Code 95J/Garnet.....	58	Grand Tour – Full Body Paint Option Code 95G/Platinum	71
Tour – Full Body Paint Option Code 95K/Crimson.....	59	Grand Tour – Full Body Paint Option Code 95H/Dark Spiral Gray.....	72
Tour – Full Body Paint Option Code 95M/Azure	60	Grand Tour – Full Body Paint Option Code 95J/Sandstone.....	73
Grand Tour – Full Body Paint Option Code 24B/Titanium.....	61	Grand Tour – Full Body Paint Option Code 95K/Bordeaux.....	74
Grand Tour – Full Body Paint Option Code 24C/Bordeaux.....	62	Grand Tour – Full Body Paint Option Code 95M/Midnight	75
Grand Tour – Full Body Paint Option Code 24H/Sunray.....	63		
Grand Tour – Full Body Paint Option Code 24L/Autumn Frost	64		

How To Use This Guide

Use the Table of Contents and identify the vehicle model and scroll to the appropriate page. You will note that some examples illustrate schemes with accent paint and decals/graphics and other illustrations are showing Full-Body Paint schemes. You can select the proper code by the accompanying color description.

The exterior graphics package is designated by a 3-digit option number (Examples: 27G, 92K). If unsure of a graphics package because the color descriptions are similar, you can confirm the correct exterior paint option number from several sources:

- The vehicle’s optional equipment list which can be found in the Operator’s Manual Supplement
- The Motor Home Component Information Sheet found in the motor home InfoCase
- The vehicle’s original window sticker
- Winnebago Industries dealerships can access paint information for a specific motor home. Using the coach serial number, go to Vehicle Information/Appliance Model/Serial. This will indicate Dupont or CDI/Sikkens and give the corresponding paint code
- The information can also be accessed by serial number on our website at <http://dealer.winnebagoind.com/unitsearch/parts.htm>. Below are examples of what to look for in the serial parts listing:

WINNEBAGO SERVICE PART ALPHA LIST 10P73441 WKR42QD MFG DATE: 05/08/12			
OPT	DESC	OPT	DESC
DM3	APOLLO/TAN/GLAZED H CHERRY	1DF	EXT TV ENTERTAINMENT CENTER
12A	ALL ELECTRIC COACH	13E	MICROWAVE/SPEEDCOOK OVEN
14C	FIREPLACE-ELECTRIC	15D	INFOTAINMENT CENTER/GPS
21S	WASHER & DRYER-PAIR	214	DISHWASHER DRAWER STYLE
23N	COMPARTMENT TRAY SLIDEOUT	24B	FBP AUTUMN FROST
282	SOLAR PANEL - 100 WATT	35T	VALANCE PANEL TRIM-SST

WINNEBAGO SERVICE PART ALPHA LIST 10P73303 WM524J MFG DATE: 04/27/12			
OPT	DESC	OPT	DESC
D43	CONNECT/SISAL/SUNSET CHERRY	086	INTERIOR UPGRADE PACKAGE
1DJ	EXTERIOR SPEAKER SYSTEM	141	DINETTE - ULTRALEATHER
23T	DRAINAGE SYSTEM-HEATED	26H	PNT&GR LT. TITANIUM
279	APPLIQUE PKG - CAB AREA	28D	WINDOW BLINDS_(3) CAB
29B	WATER PURIFIER	29Z	A/C 14,800 - HEAT PUMP
33F	GEN-3.2 KW ONAN DIESEL	401	INVERTER-DC/AC, 1000 WATT

Full-Body Paint (FBP) is performed by CDI, a company adjacent to the Winnebago Industries factory. For information or repair approval specific to CDI paint, excluding transportation damage, contact CDI directly at 641-585-5900.

Minnie Winnie



Option Code 26J – Bronzemist

Main Body Color

Champagne – 890289K

Upper & Lower Body

Bronzemist Metallic – 817229K

Graphics

Tuscan Gold Metallic – 995150

Black Metallic – 990959

Taupe – 995125

Bright White II – 990923



Option Code 27H– Tuscan Gold Champagne

Main Color

Champagne – 890289K

Front Cap

Mocha – 565787K

Graphics

Tuscan Gold Metallic – 995150

Black Metallic – 990959

Taupe – 995125

Bright White II – 990923



Option Code 92D– Polar Tuscan Gold

Main Color

Bright White – B8951

Front Cap

Mocha – 565787K

Graphics

Tuscan Gold Metallic – 995150

Black Metallic – 990959

Taupe – 995125

Bright White II – 990923

Fuse



Option Code 26F – Lunar Sky

Cab/Body

Lunar Sky Metallic – 885168K

Sidewall

Champagne – 890289K

Graphics

Tabasco Pearl Metallic – 550949K

Black Metallic – DM358K

Lunar Sky Metallic – 885168K



Option Code 26H – Magnetic

Cab/Body

Magnetic – 88653K

Sidewall

Champagne – 890289K

Graphics

Tabasco Pearl Metallic – 550949K

Black Metallic – DM358K

Magnetic Metallic – 88653K

View



Option Code 26F – Copper Canyon

Sprinter Cab Portion

Arctic White - 741883

Main Body Color

Champagne – 890289K

Upper & Lower Body

Kalahari Beige Metallic – 861538K

Graphics

Copper Metallic – 65

Sprinter White – 741883



Option Code 26H – Carbon Red

Sprinter Cab Portion

Arctic White - 741883

Main Color

Champagne – 890289K

Upper & Lower Body

Carbon Bronze Metallic – 861539K

Graphics

Henna Metallic – 995185

Sprinter White – 741883

View - Full Body Paint Option Code 24B/Bay Mist

Painted by CDI*

Dk. Spiral Gray Met.
Sikkens FLNA 94349

Silver Met.
Sikkens FLNA 94332
Revised 12-11-15

White
Chrysler body color
#41162



Pewter Pearl Met.
Sikkens FLNA 94170-1



*Full-Body Paint (FBP) is performed by CDI. For information or repair approval specific to CDI paint, excluding transportation damage, contact CDI directly at 641/585-5900.

View - Full Body Paint Option Code 24C/Pumpkin Spice

Painted by CDI*

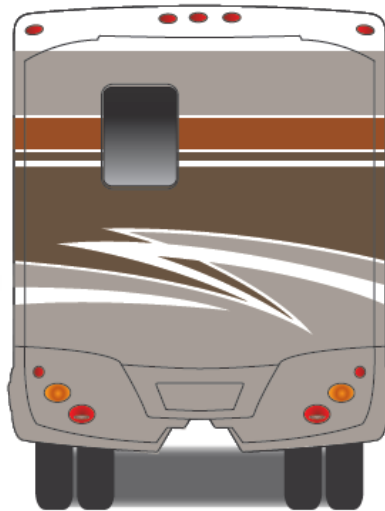

Dk. Bronzemist Met.
Sikkens FLNA 94344-1



*Full-Body Paint (FBP) is performed by CDI. For information or repair approval specific to CDI paint, excluding transportation damage, contact CDI directly at 641/585-5900.

View - Full Body Paint Option Code 24H/Iris

Painted by CDI*

Bright Blue Met.
Sikkens FLNA 94338

Pewter Pearl Met.
Sikkens FLNA 94169-2

White
Chrysler body color
#41162



Blackmist Met.
Sikkens FLNA 94194



*Full-Body Paint (FBP) is performed by CDI. For information or repair approval specific to CDI paint, excluding transportation damage, contact CDI directly at 641/585-5900.

View - Full Body Paint Option Code 24L/Beechwood

Painted by CDI*

Lava Gray Met.
Sikkens FLNA 94860

Antique Sage Met.
Sikkens FLNA 94198

White
Chrysler body color
#41162



Polished Pewter Met.
Sikkens FLNA 94199



*Full-Body Paint (FBP) is performed by CDI. For information or repair approval specific to CDI paint, excluding transportation damage, contact CDI directly at 641/585-5900.

View - Full Body Paint Option Code 27A/Coffee

Painted by CDI*

Gold Met.
Sikkens FLNA 94339

Dk. Beige Met.
Sikkens FLNA 94152

White
Chrysler body color
#41162

Blackmist Met.
Sikkens FLNA 94194

*Full-Body Paint (FBP) is performed by CDI. For information or repair approval specific to CDI paint, excluding transportation damage, contact CDI directly at 641/585-5900.



View - Full Body Paint Option Code 92A/Tuscarar Sun

Painted by CDI*

Torreador Red Met.
Sikkens FLNA 94317

Sandstone Beige Met.
Sikkens FLNA 94173-1

White
Chrysler body color
#41162



Black Mist Met.
Sikkens FLNA 94194



*Full-Body Paint (FBP) is performed by CDI. For information or repair approval specific to CDI paint, excluding transportation damage, contact CDI directly at 641/585-5900.

Trend



Option Code 92K – Echo Red

Main Body Color

Bright White – B8951

Cab & Accent Color

Brilliant Silver Metallic – H9672K

Graphics

Bright Silver Metallic – H9672K

Black Metallic – 995327

Red Candy Flash Metallic – 450

Aspect



Option Code 26J – Light Bronze

Main Color

Light Bronze Metallic – 823982K

Sidewall

Champagne – 890289K

Graphics

Scarlet Red Metallic – 401672

Dark Cherry Metallic – RM511K

Aspect - Full Body Paint Option Code 24B/Garnet

Painted by CDI*



*Full-Body Paint (FBP) is performed by CDI. For information or repair approval specific to CDI paint, excluding transportation damage, contact CDI directly at 641/585-5900.



Aspect - Full Body Paint Option Code 24C/Silver Smoke

Painted by CDI*

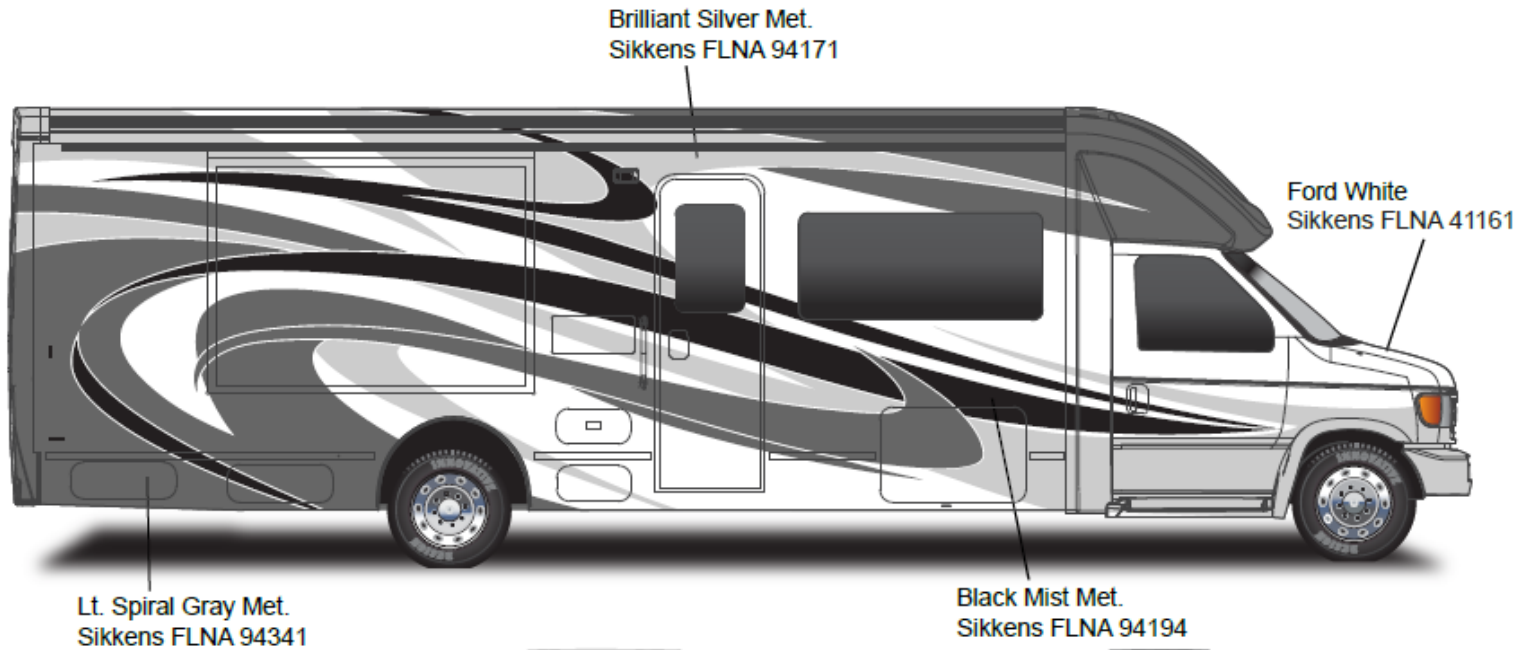

*Full-Body Paint (FBP) is performed by CDI. For information or repair approval specific to CDI paint, excluding transportation damage, contact CDI directly at 641/585-5900.



Aspect - Full Body Paint Option Code 27A/Windveil

Painted by CDI*



*Full-Body Paint (FBP) is performed by CDI. For information or repair approval specific to CDI paint, excluding transportation damage, contact CDI directly at 641/585-5900.

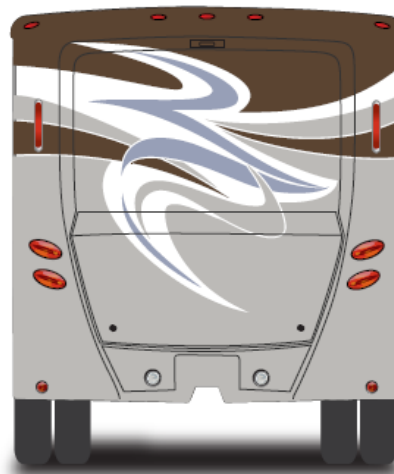

Aspect - Full Body Paint Option Code 92A/Crimson

Painted by CDI*



*Full-Body Paint (FBP) is performed by CDI. For information or repair approval specific to CDI paint, excluding transportation damage, contact CDI directly at 641/585-5900.



Brave



Option Code 24A – Woodstock

Main Body Color

Bright White – B8951

Lower Body

Antique Sage Metallic – 822143K

Graphics

Henna Metallic – 995185

Dark Charcoal Metallic – 990568



Option Code 27C – Aquarius

Main Color

Bright White – B8951

Lower Body

Summerfield Metallic – 890591K

Graphics

Ivy Green Metallic – 990561

Mesa Metallic – 990907



Option Code 24E – Made-N-The-Shade

Main Color

Bright White – B8951

Lower Body

Iron Gray Metallic – 823985K

Graphics

Cobblestone Metallic – 400601

Black Metallic – DM358K

Brave



Option Code 92D – Mellow Yellow

Main Body Color

Bright White – B8951

Lower Body

Sport Yellow – YS911K

Graphics

Cobblestone Metallic – 400601

Canary Yellow Metallic – 990960



Option Code 92F – Bellbottom Blue

Main Body Color

Bright White – B8951

Lower Body

Gunmetal Metallic – 890592K

Graphics

Light Blue Metallic – 990909

Dark Tundra Metallic – 990443



Option Code 27H – Crimson-n-Clover

Main Color

Bright White – B8951

Lower Body

Cinnamon – 890590K

Graphics

Khaki Metallic – F4574

Scarlet Red Metallic – 401672

Brave - Full Body Paint Option Code 27A/Daytona

Painted by CDI*

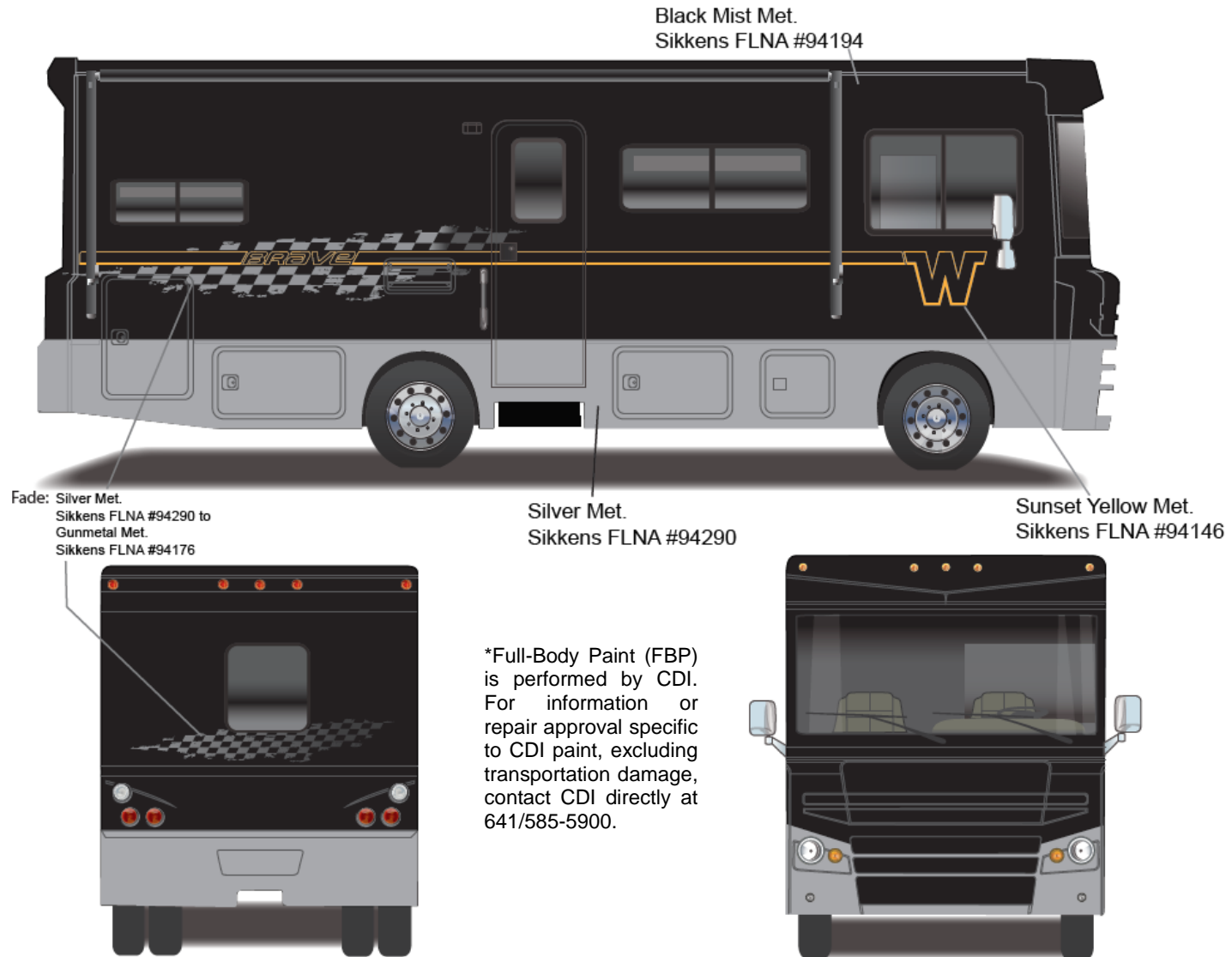

Sightseer - Full Body Paint Option Code 24B/Ember

Painted by CDI*

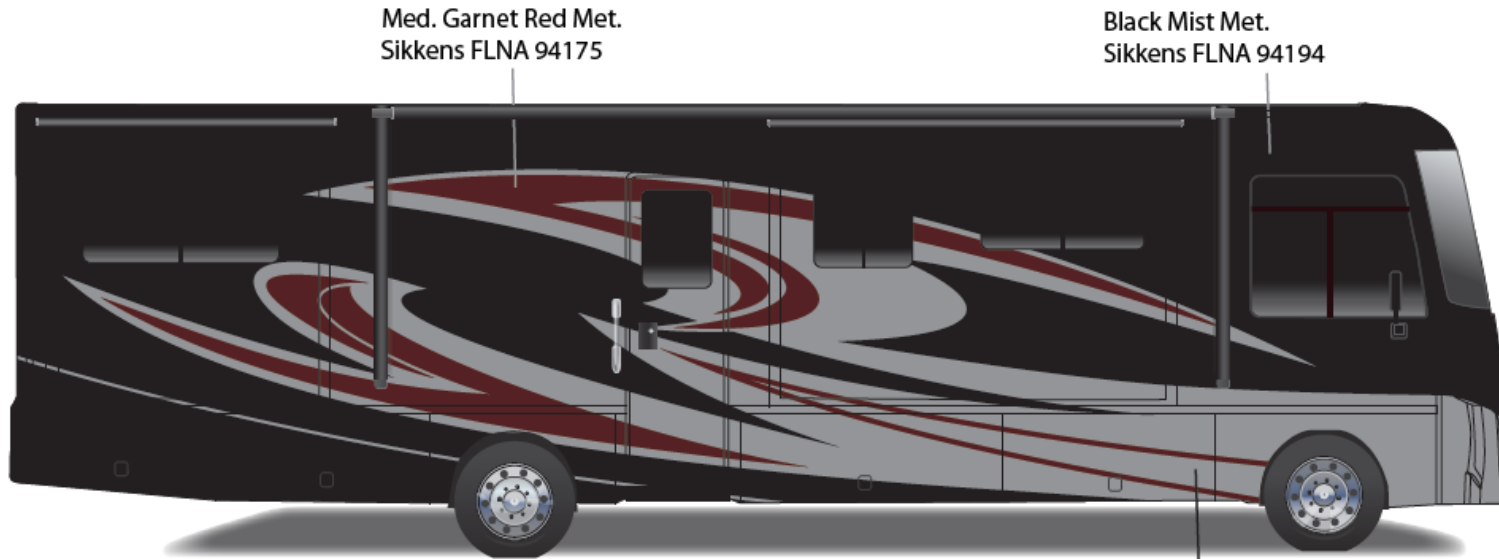

*Full-Body Paint (FBP) is performed by CDI. For information or repair approval specific to CDI paint, excluding transportation damage, contact CDI directly at 641/585-5900.



Sightseer - Full Body Paint Option Code 24C/Black Garnet

Painted by CDI*



Silver Sage Met.
Sikkens FLNA 94221-3 main

*Full-Body Paint (FBP) is performed by CDI. For information or repair approval specific to CDI paint, excluding transportation damage, contact CDI directly at 641/585-5900.

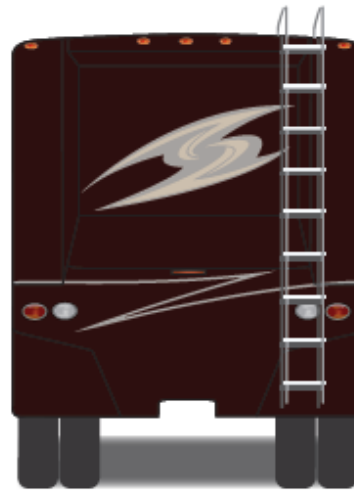

Sightseer - Full Body Paint Option Code 27A/Cloud

Painted by CDI*

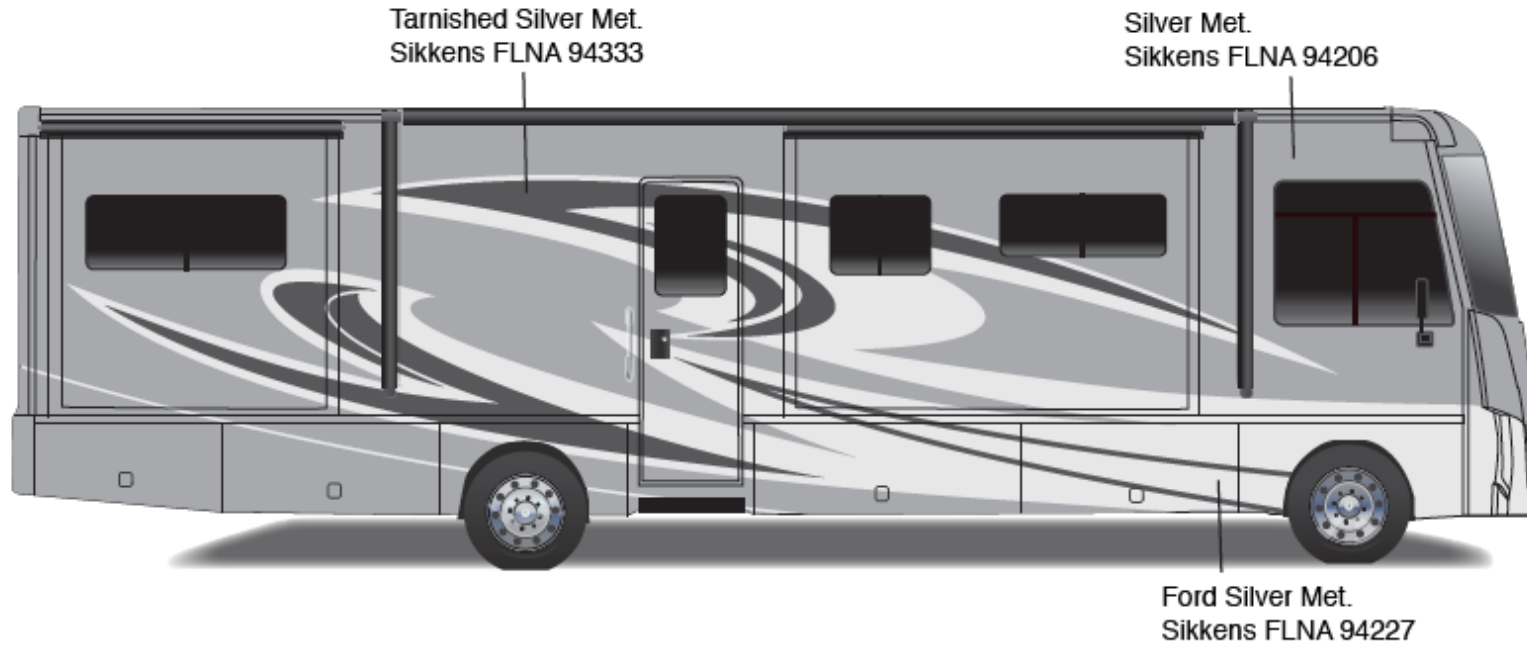

*Full-Body Paint (FBP) is performed by CDI. For information or repair approval specific to CDI paint, excluding transportation damage, contact CDI directly at 641/585-5900.



Sightseer - Full Body Paint Option Code 92A/Cream

Painted by CDI*



*Full-Body Paint (FBP) is performed by CDI. For information or repair approval specific to CDI paint, excluding transportation damage, contact CDI directly at 641/585-5900.

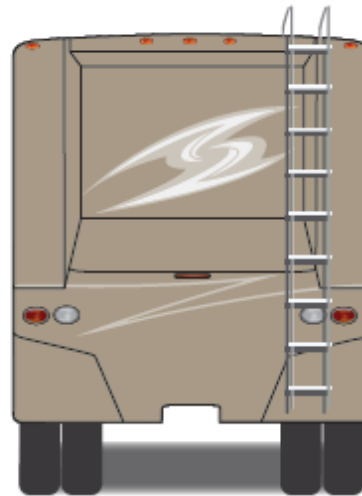

Vista



Option Code 27G – Solar Flare

Main Body Color

Champagne – 890289K

Front Cap Gel Coat

Mocha – 565787K

Champagne – 890289K **RLC**

Graphics

Taupe – 995125

Henna Metallic – 995185



Vista LX

Option Code 92K – Solar Flare Pearl

Main Color

Mocha – 565787K

Champagne – 890289K **RLC**

Graphics

Taupe – 995125

Henna Metallic – 995185

Pearl Diamond Metallic - 93

Vista - Full Body Paint Option Code 24B/Spiral Gray

Painted by CDI*



*Full-Body Paint (FBP) is performed by CDI. For information or repair approval specific to CDI paint, excluding transportation damage, contact CDI directly at 641/585-5900.



Vista - Full Body Paint Option Code 24C/Cayenne

Painted by CDI*

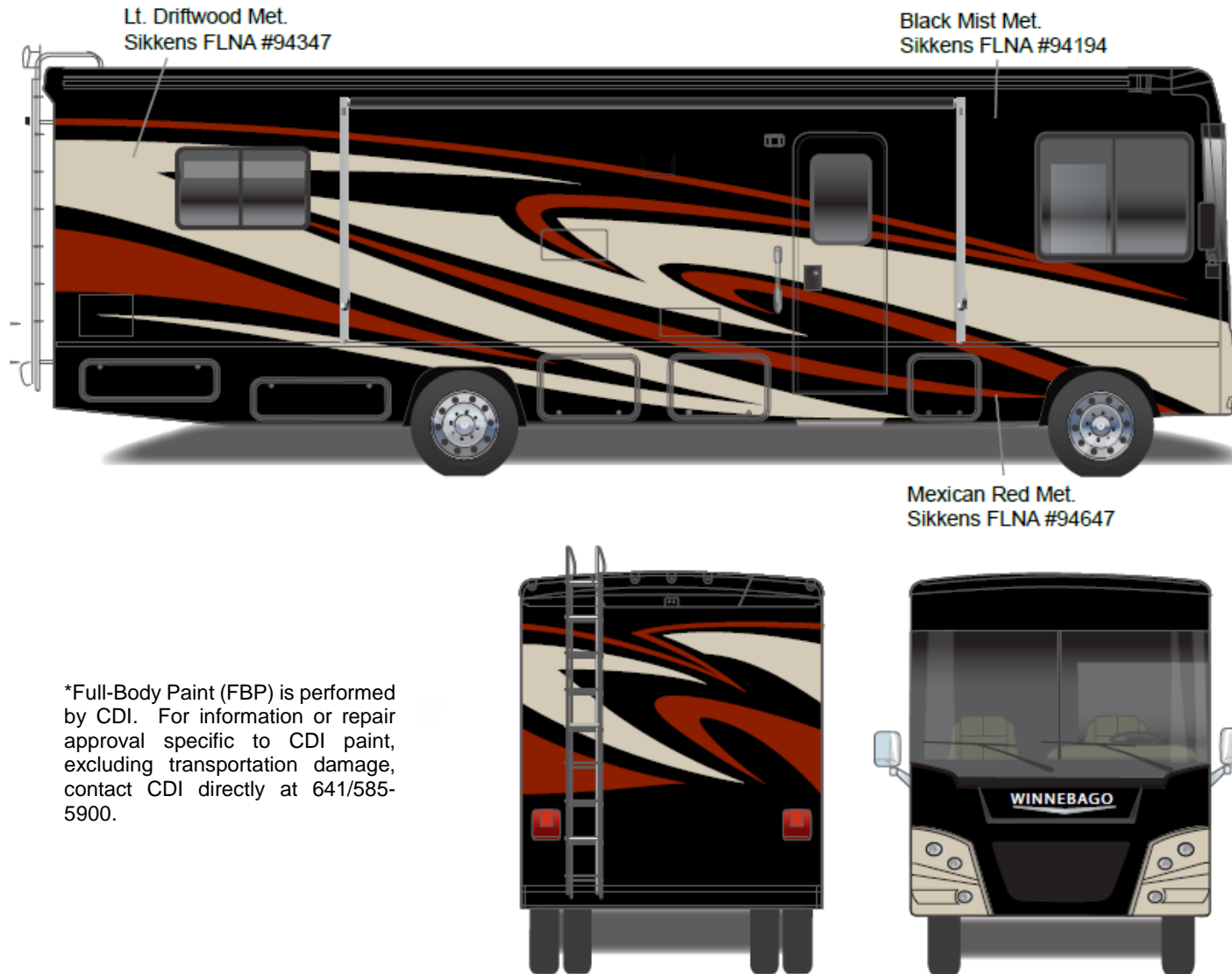

*Full-Body Paint (FBP) is performed by CDI. For information or repair approval specific to CDI paint, excluding transportation damage, contact CDI directly at 641/585-5900.

Vista - Full Body Paint Option Code 27A/Cream

Painted by CDI*

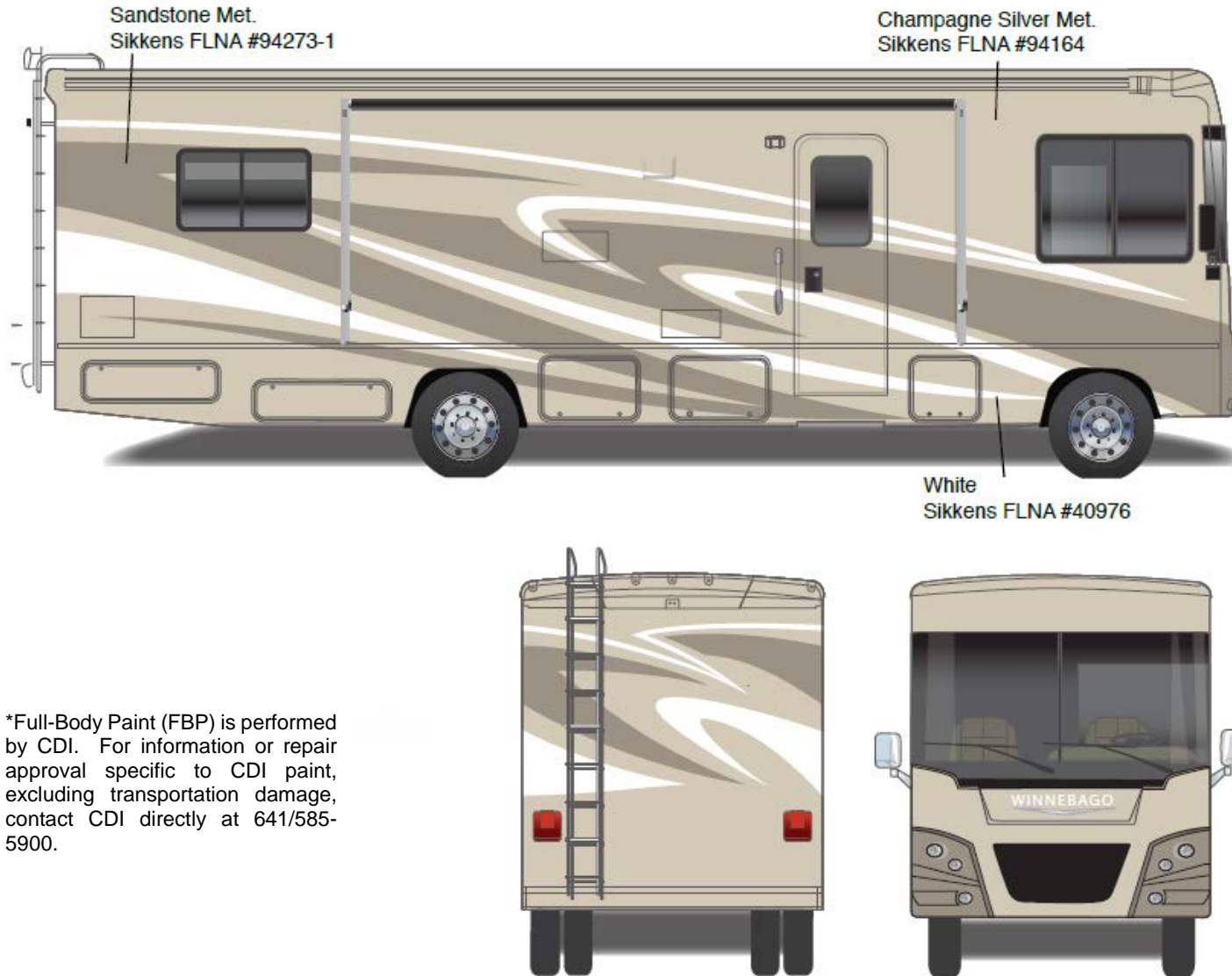

*Full-Body Paint (FBP) is performed by CDI. For information or repair approval specific to CDI paint, excluding transportation damage, contact CDI directly at 641/585-5900.

Vista - Full Body Paint Option Code 92A/Arctic Silver

Painted by CDI*

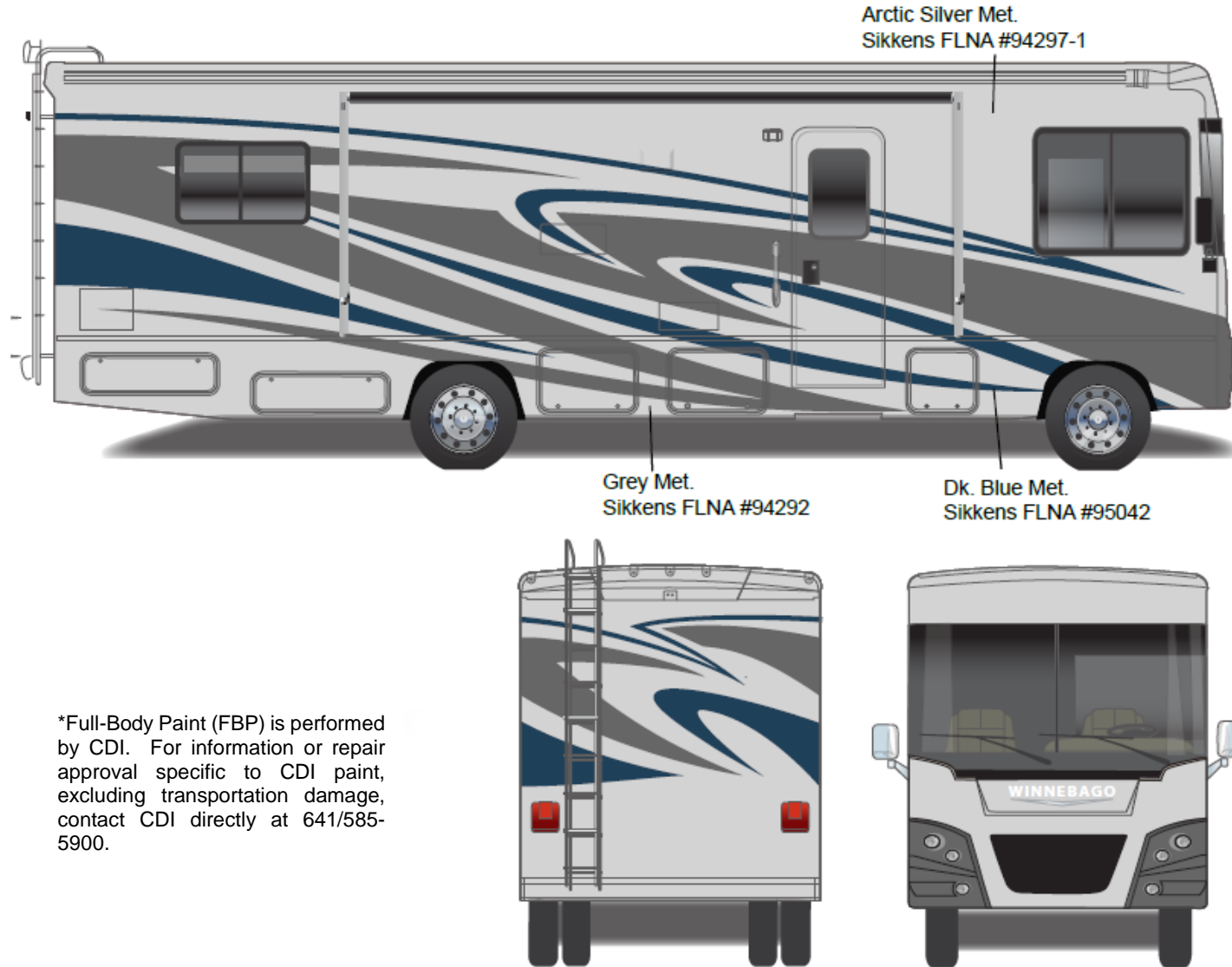

*Full-Body Paint (FBP) is performed by CDI. For information or repair approval specific to CDI paint, excluding transportation damage, contact CDI directly at 641/585-5900.

Via



Option Code 26F – Dark Bronzemist

Main Body Color

Champagne – 890289K

Upper Body

Light Pearlstone Metallic – 823983K

Lower Body

Dark Bronzemist Metallic – 817229K

Graphics

Scarlet Red Metallic – 990567

Dark Cherry Metallic – 990606

Via - Full Body Paint Option Code 27A/Charcoal Bronze

Painted by CDI*

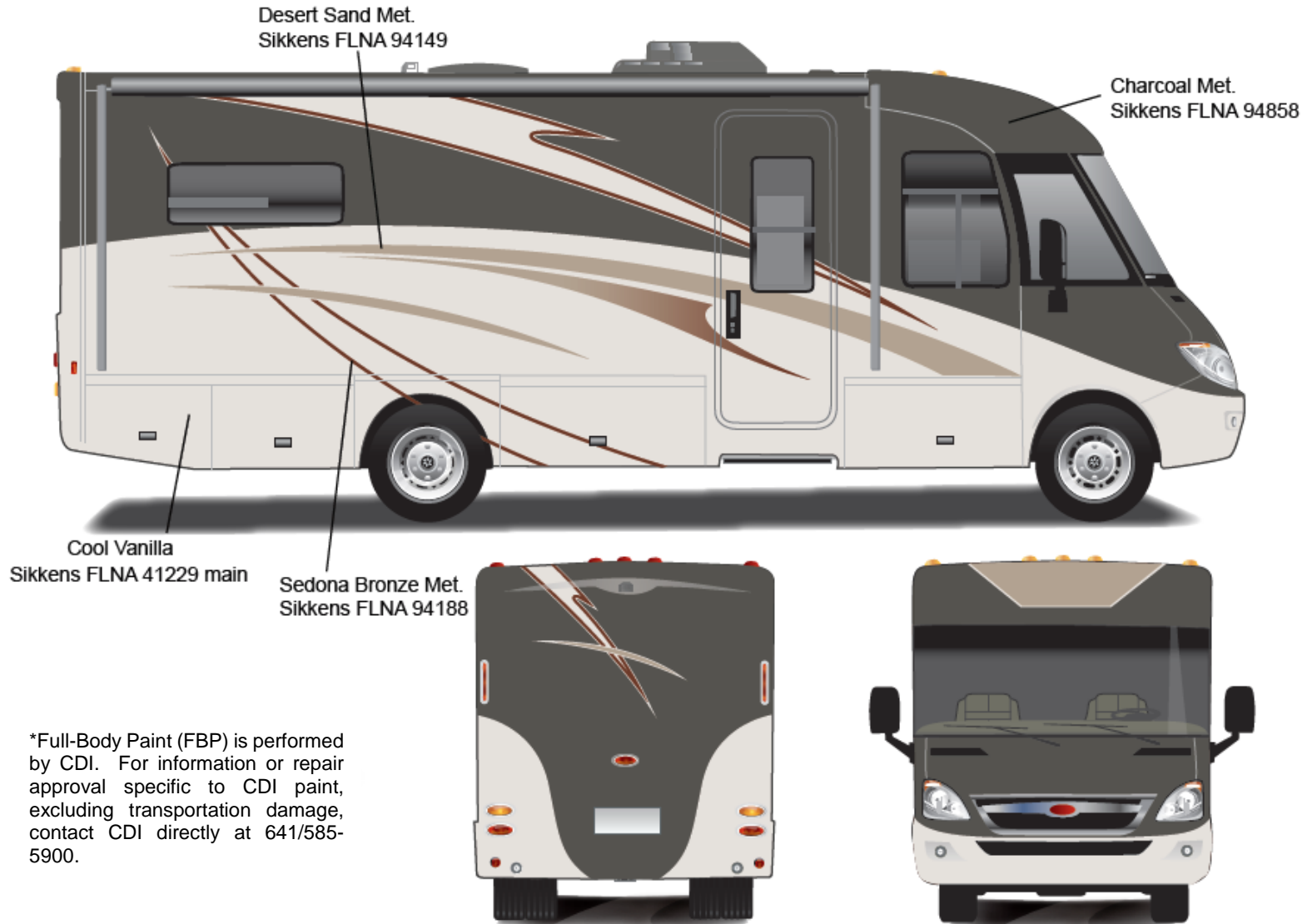

*Full-Body Paint (FBP) is performed by CDI. For information or repair approval specific to CDI paint, excluding transportation damage, contact CDI directly at 641/585-5900.

Via – Full Body Paint Option Code 92A/Stormy Gray

Painted by CDI*

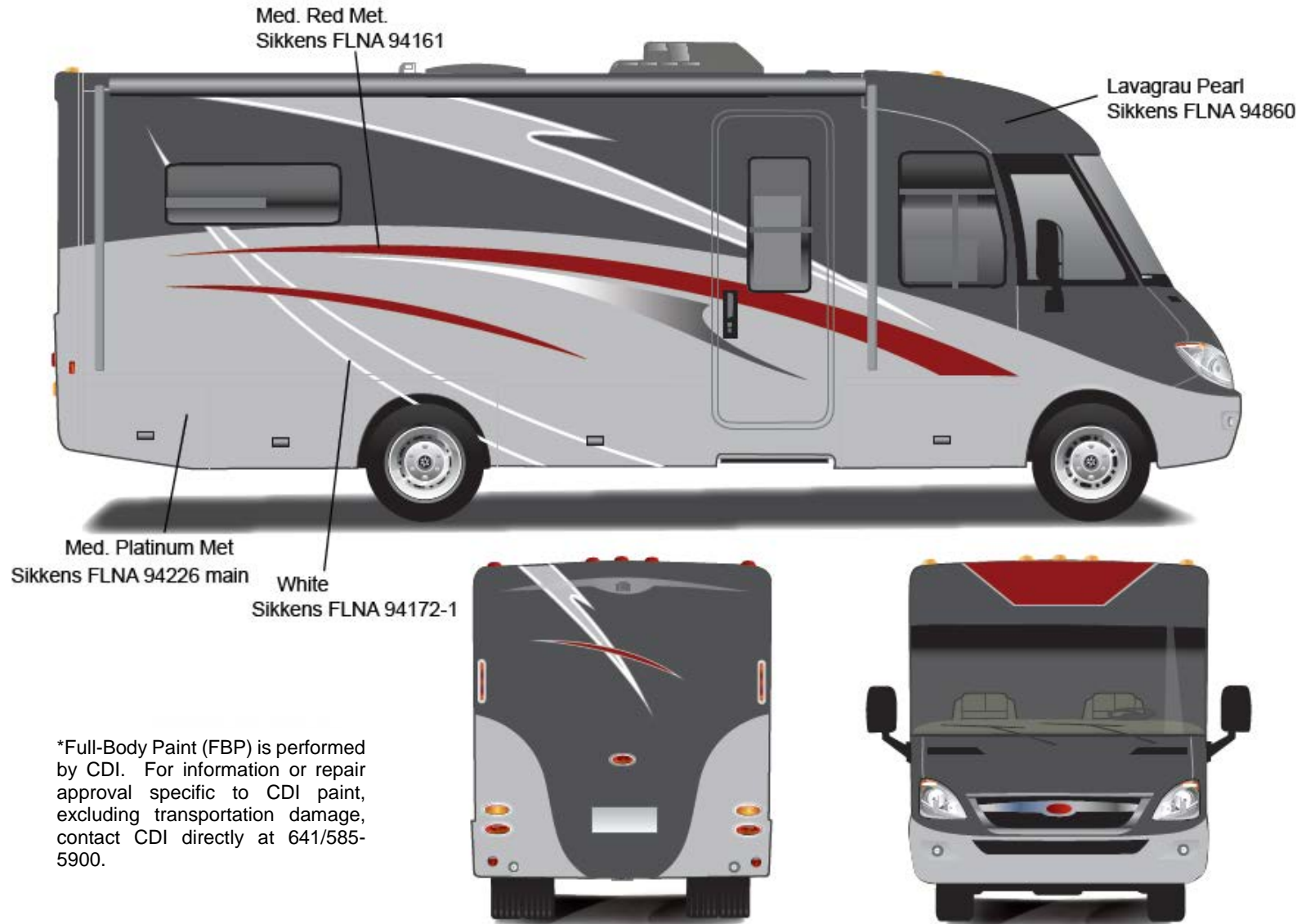

*Full-Body Paint (FBP) is performed by CDI. For information or repair approval specific to CDI paint, excluding transportation damage, contact CDI directly at 641/585-5900.

Adventurer - Full Body Paint Option Code 24B/Black Walnut

Painted by CDI*

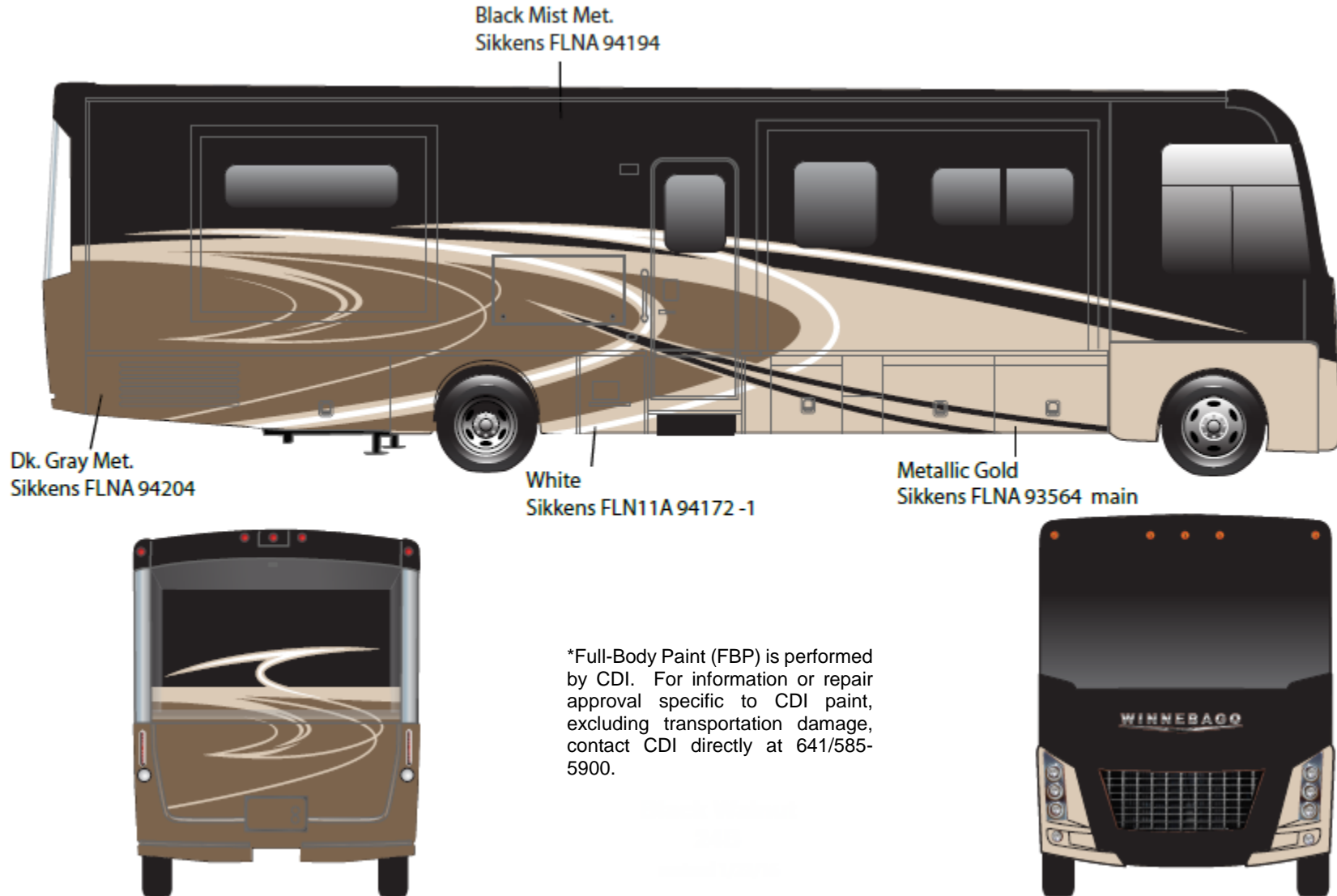

Adventurer - Full Body Paint Option Code 24C/Amber

Painted by CDI*

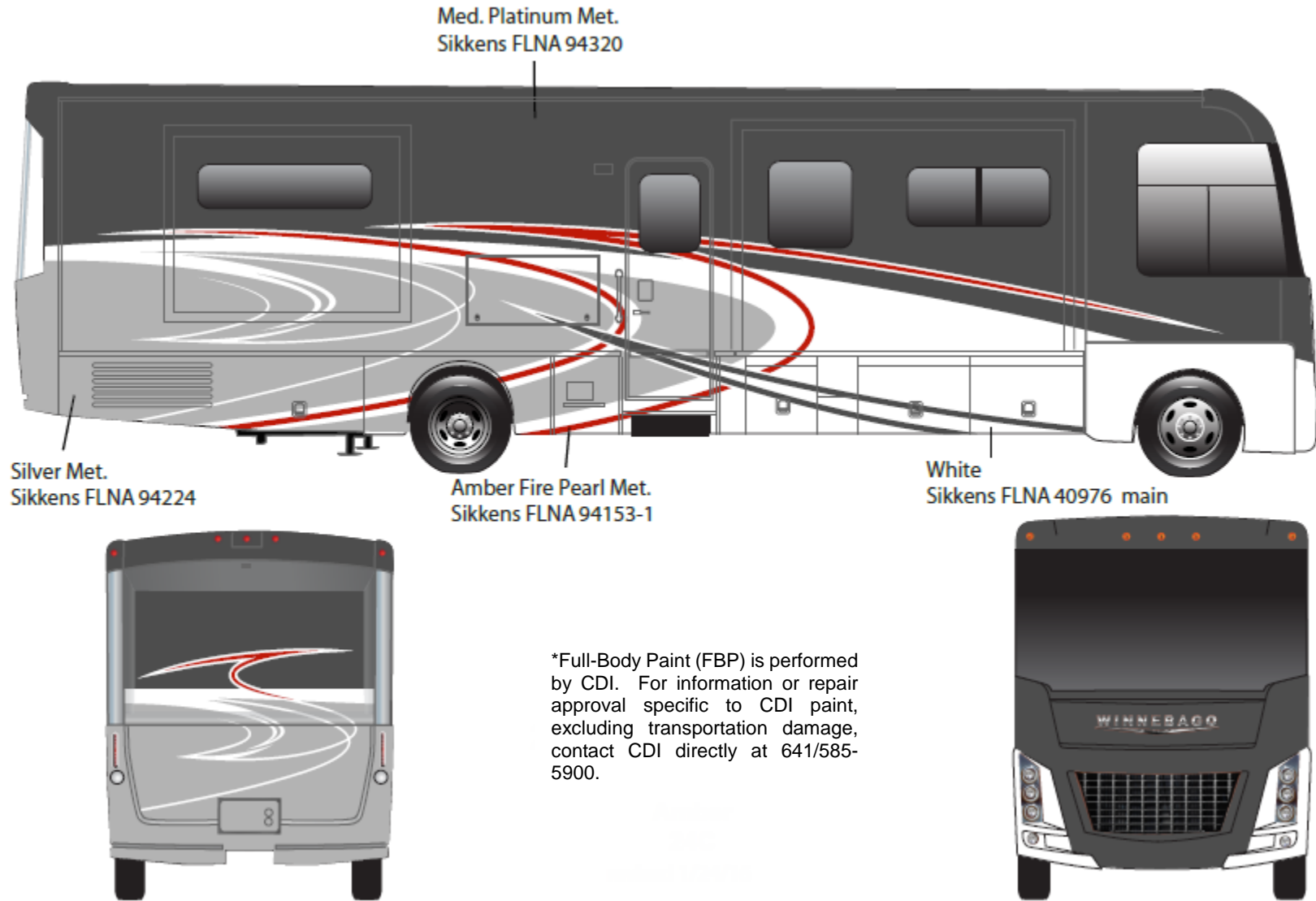

*Full-Body Paint (FBP) is performed by CDI. For information or repair approval specific to CDI paint, excluding transportation damage, contact CDI directly at 641/585-5900.

Adventurer - Full Body Paint Option Code 27A/Pewter Pearl

Painted by CDI*

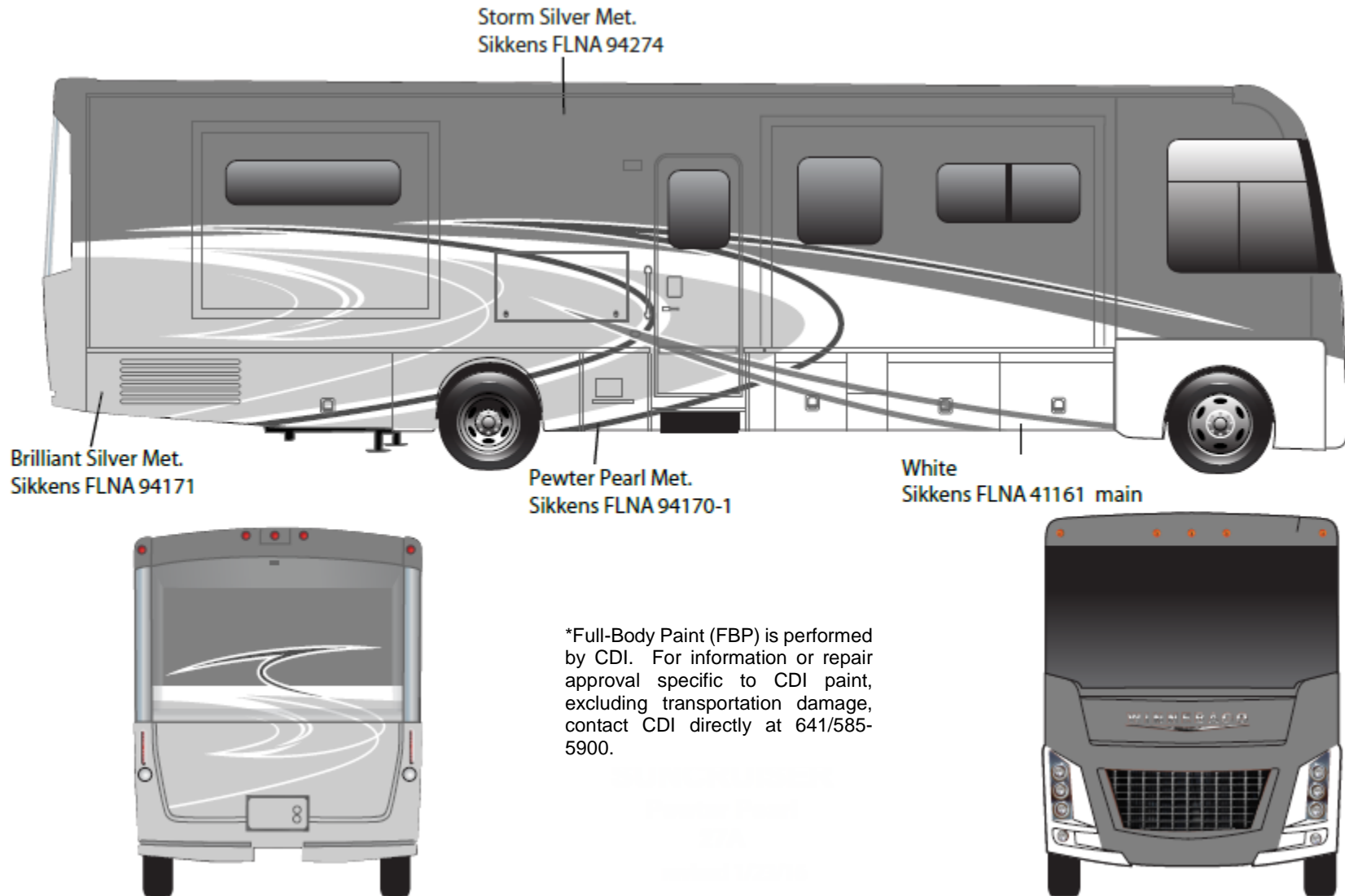

Adventurer - Full Body Paint Option Code 92A/Sapphire

Painted by CDI*

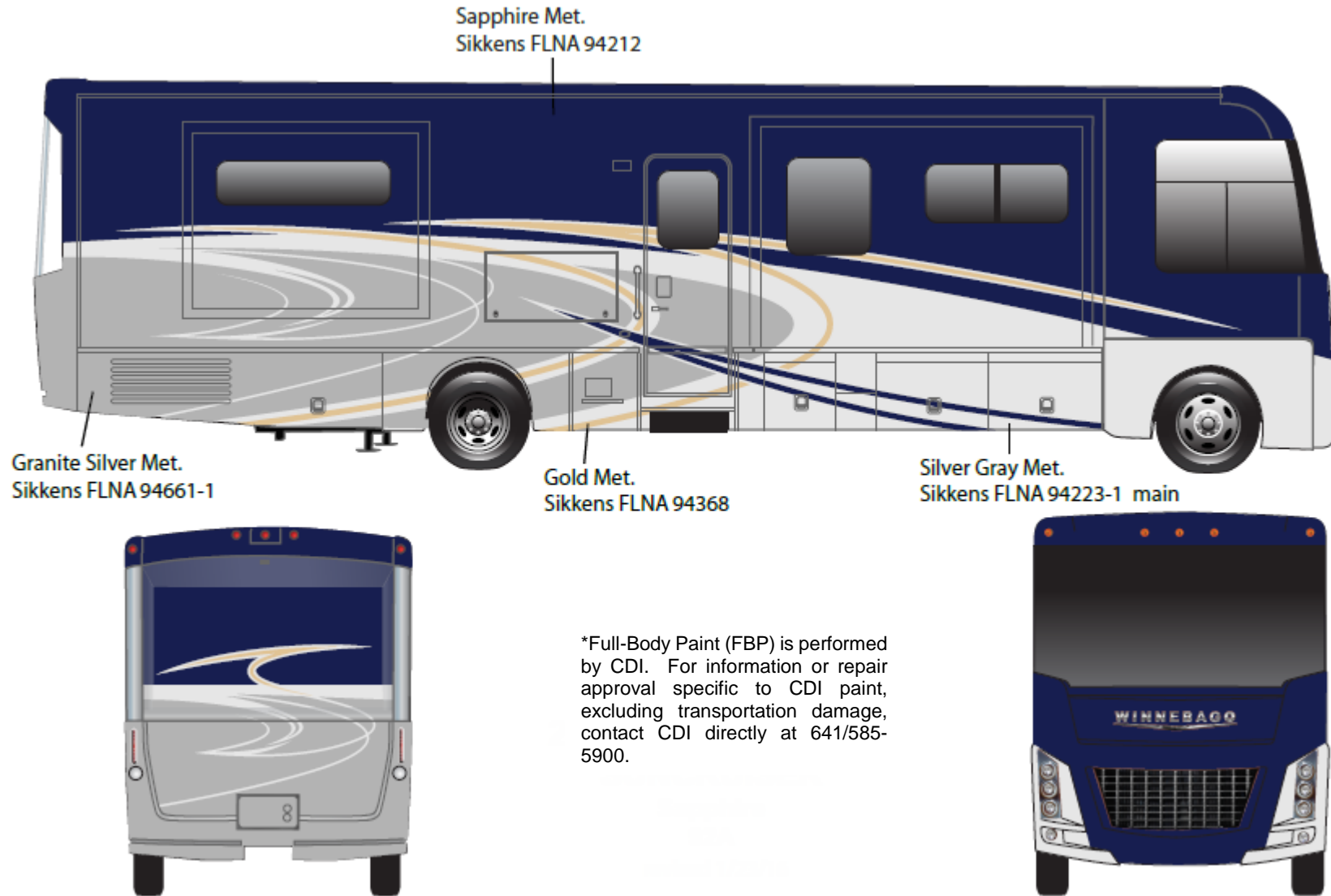

Adventurer - Full Body Paint Option Code 24L/Titanium

Painted by CDI*

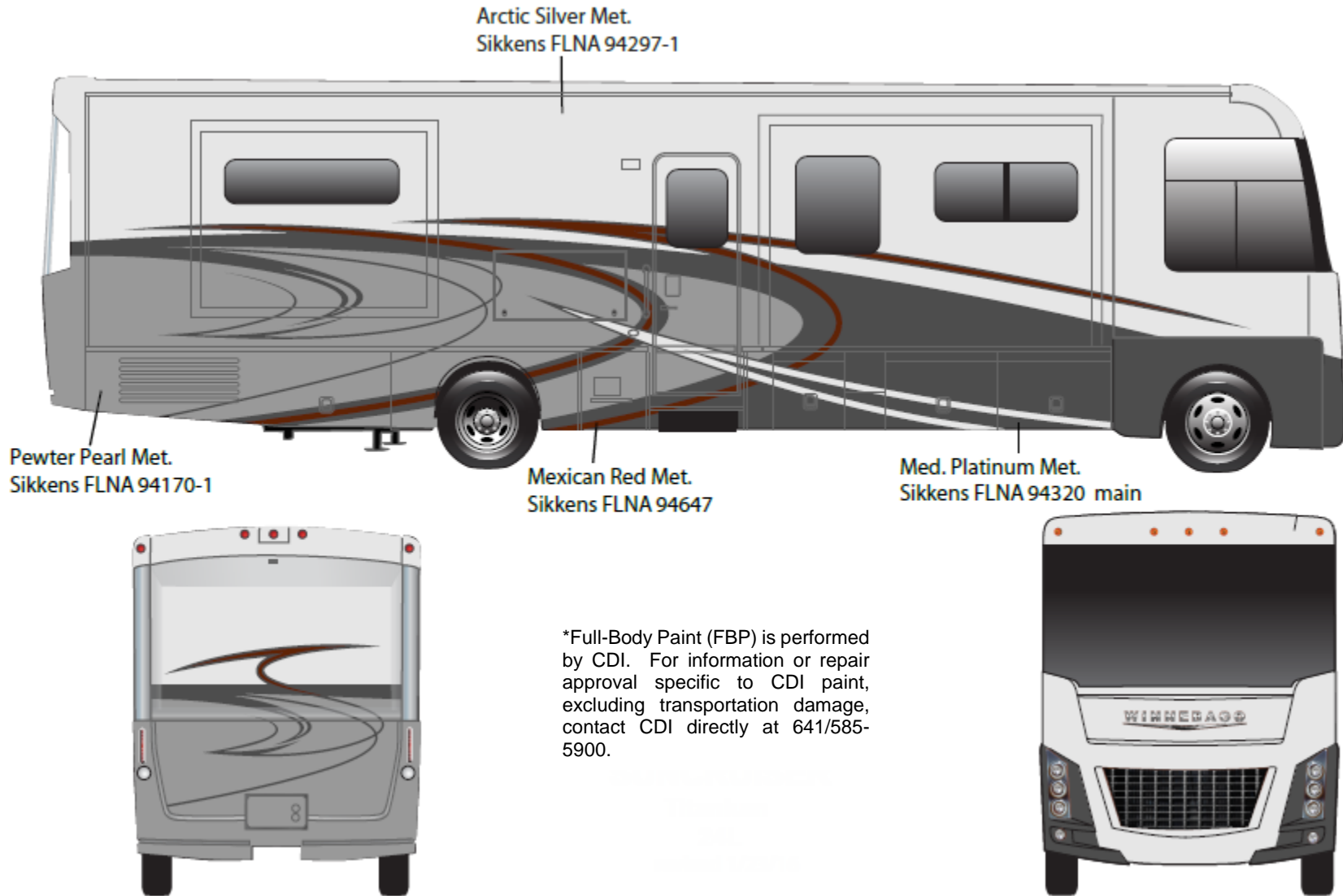

Adventurer - Full Body Paint Option Code 24H/Sandstone

Painted by CDI*

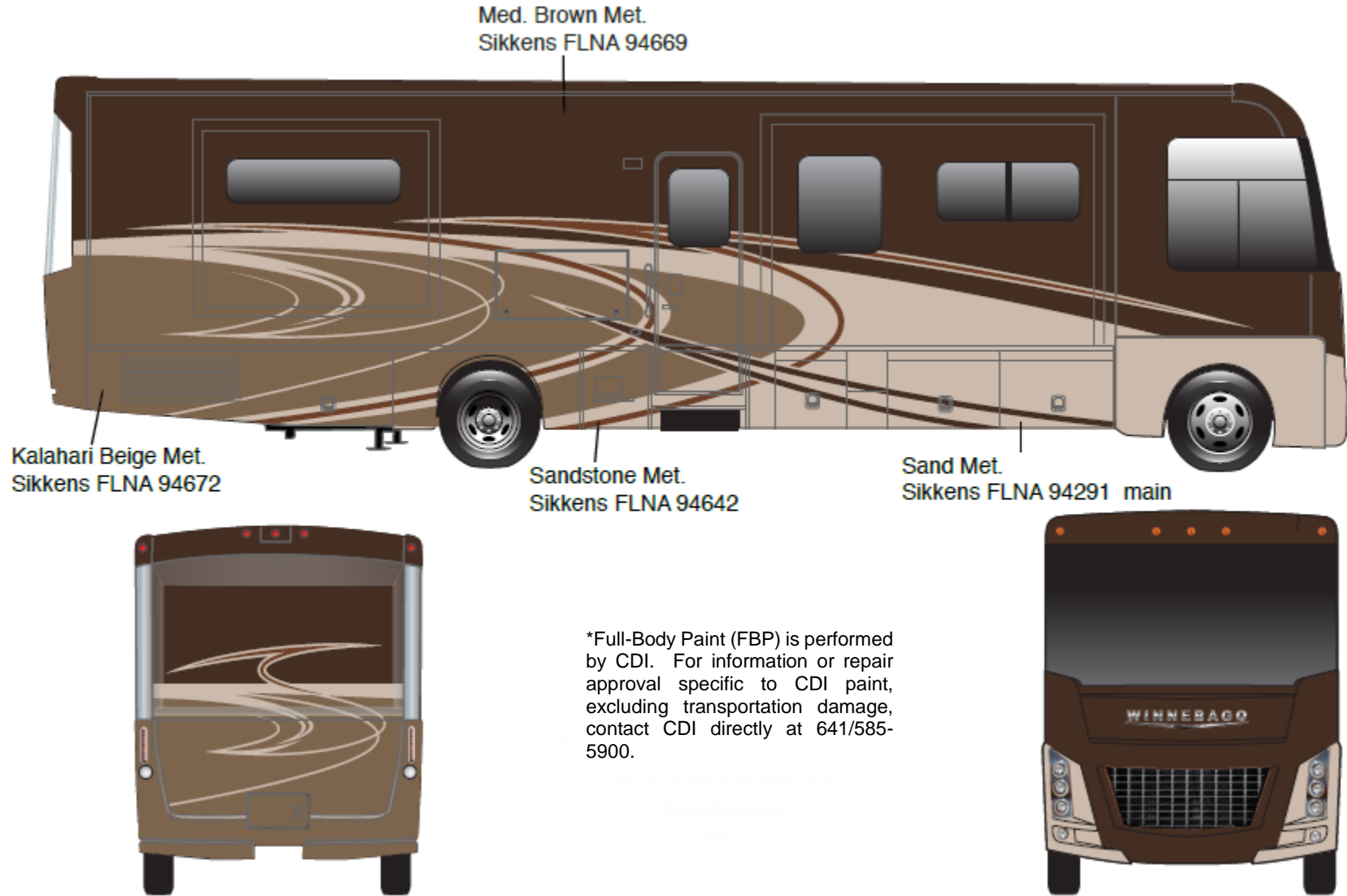

Forza - Full Body Paint Option Code 24B/Pewter

Painted by CDI*

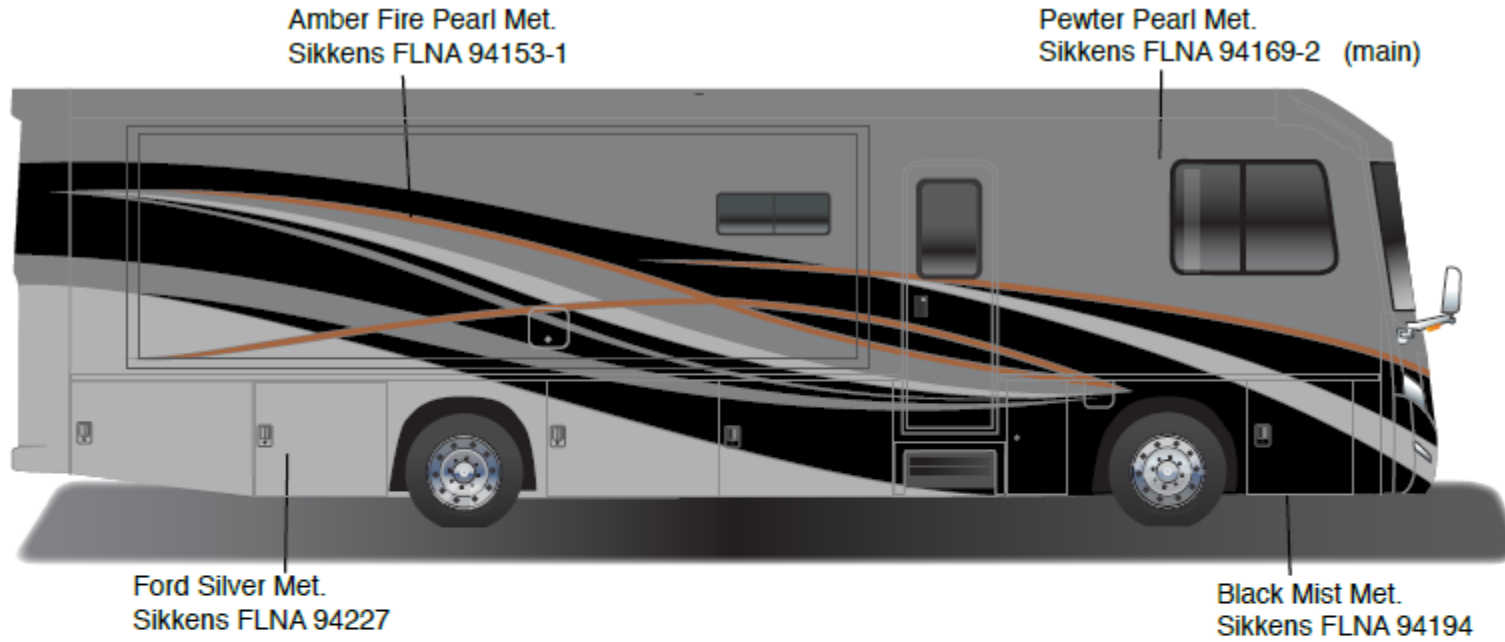

*Full-Body Paint (FBP) is performed by CDI. For information or repair approval specific to CDI paint, excluding transportation damage, contact CDI directly at 641/585-5900.



Forza - Full Body Paint Option Code 24C/Mahogany

Painted by CDI*



*Full-Body Paint (FBP) is performed by CDI. For information or repair approval specific to CDI paint, excluding transportation damage, contact CDI directly at 641/585-5900.



Forza - Full Body Paint Option Code 27A/Sandstone

Painted by CDI*



*Full-Body Paint (FBP) is performed by CDI. For information or repair approval specific to CDI paint, excluding transportation damage, contact CDI directly at 641/585-5900.



Forza - Full Body Paint Option Code 92A/Red Maple

Painted by CDI*



*Full-Body Paint (FBP) is performed by CDI. For information or repair approval specific to CDI paint, excluding transportation damage, contact CDI directly at 641/585-5900.



Forza - Full Body Paint Option Code 24H/Silver Pearl

Painted by CDI*



*Full-Body Paint (FBP) is performed by CDI. For information or repair approval specific to CDI paint, excluding transportation damage, contact CDI directly at 641/585-5900.



Forza - Full Body Paint Option Code 24L/Silver Sky

Painted by CDI*

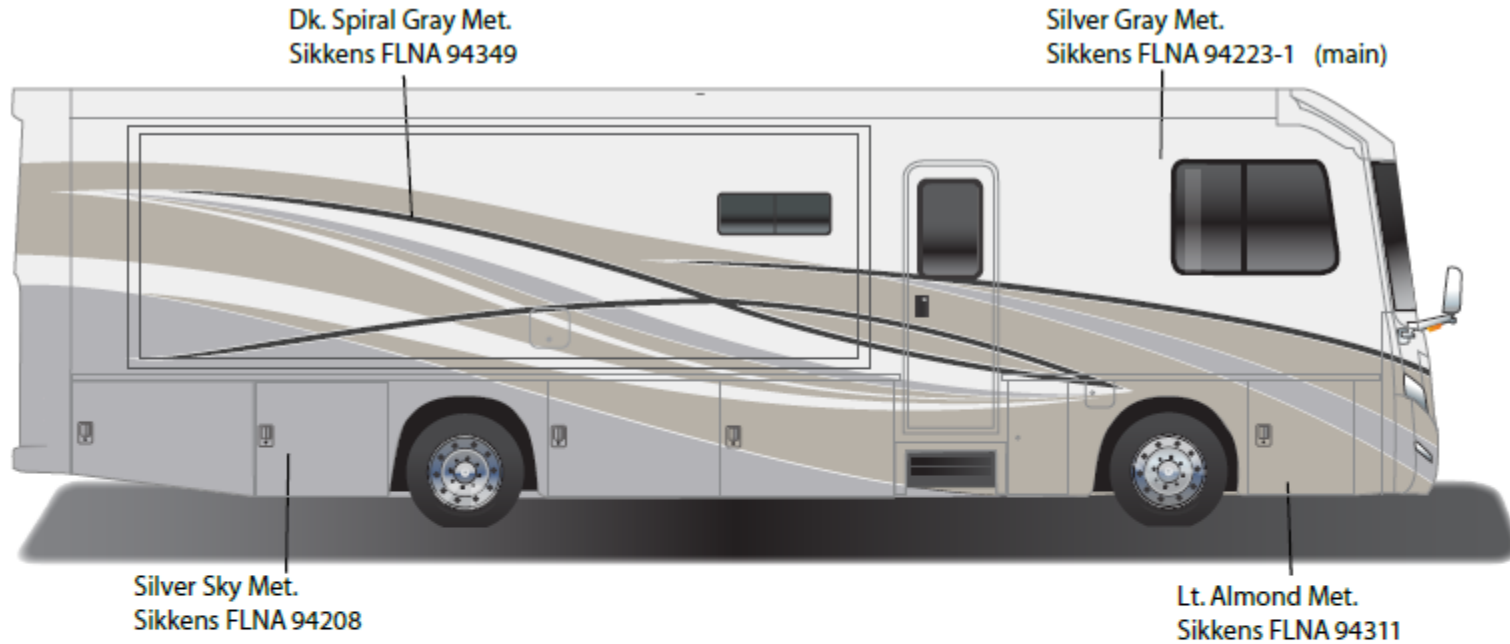

*Full-Body Paint (FBP) is performed by CDI. For information or repair approval specific to CDI paint, excluding transportation damage, contact CDI directly at 641/585-5900.



Journey - Full Body Paint Option Code 24B/Gray Mica

Painted by CDI*

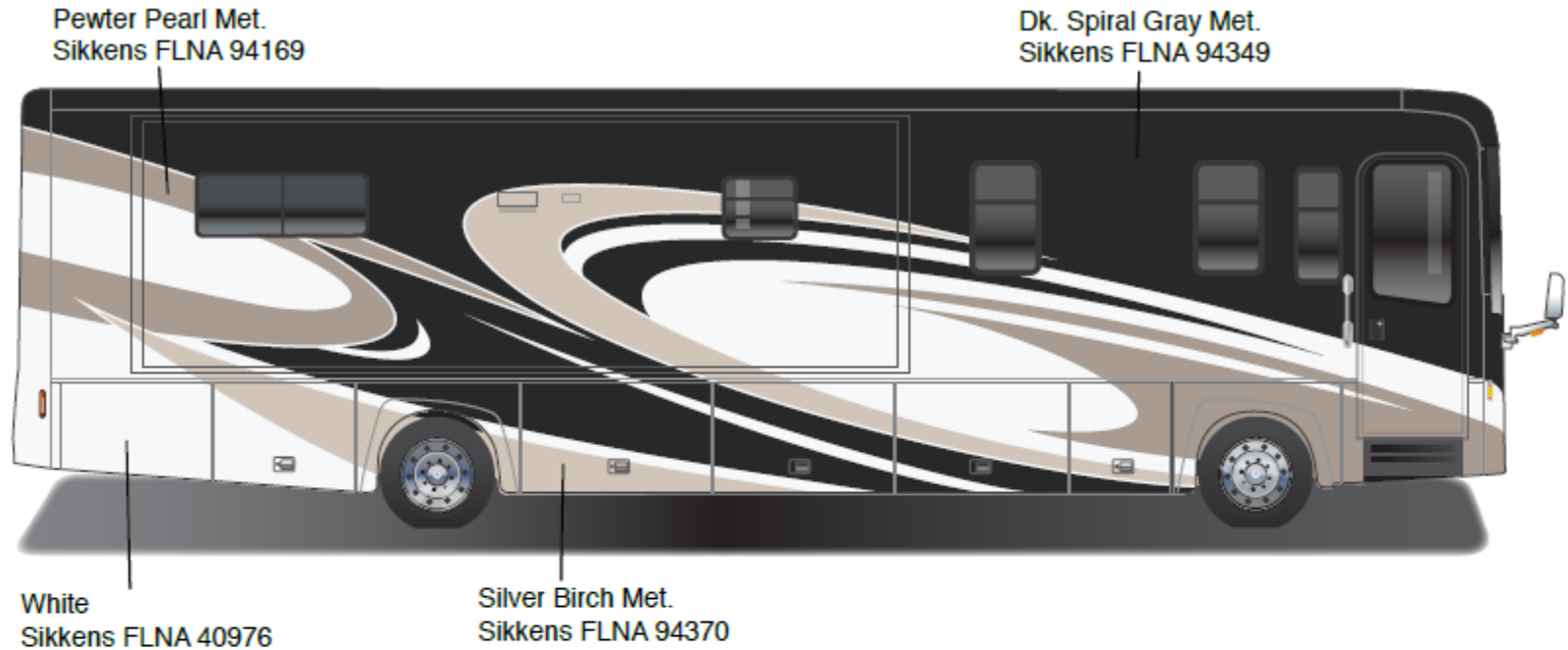

*Full-Body Paint (FBP) is performed by CDI. For information or repair approval specific to CDI paint, excluding transportation damage, contact CDI directly at 641/585-5900.



Journey - Full Body Paint Option Code 24C/Iron Gray

Painted by CDI*

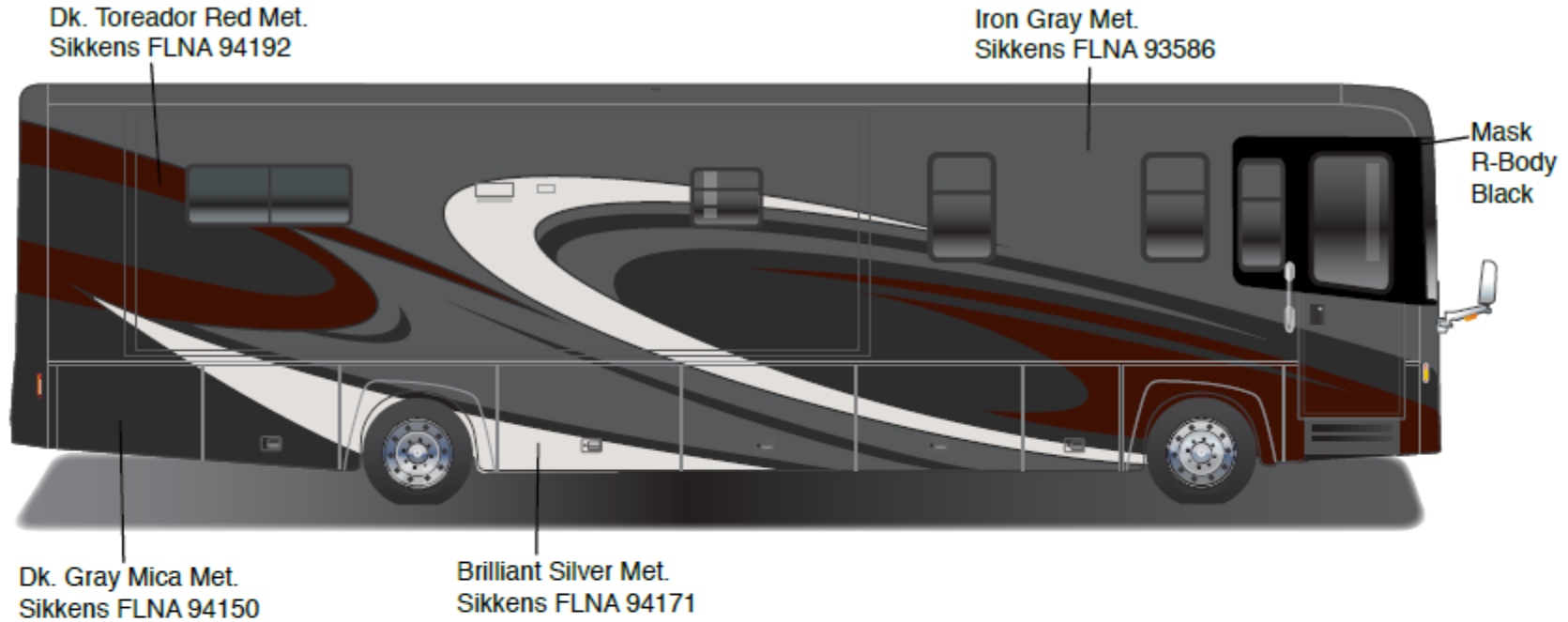

*Full-Body Paint (FBP) is performed by CDI. For information or repair approval specific to CDI paint, excluding transportation damage, contact CDI directly at 641/585-5900.



Journey - Full Body Paint Option Code 24H/Creamy Vanilla

Painted by CDI*

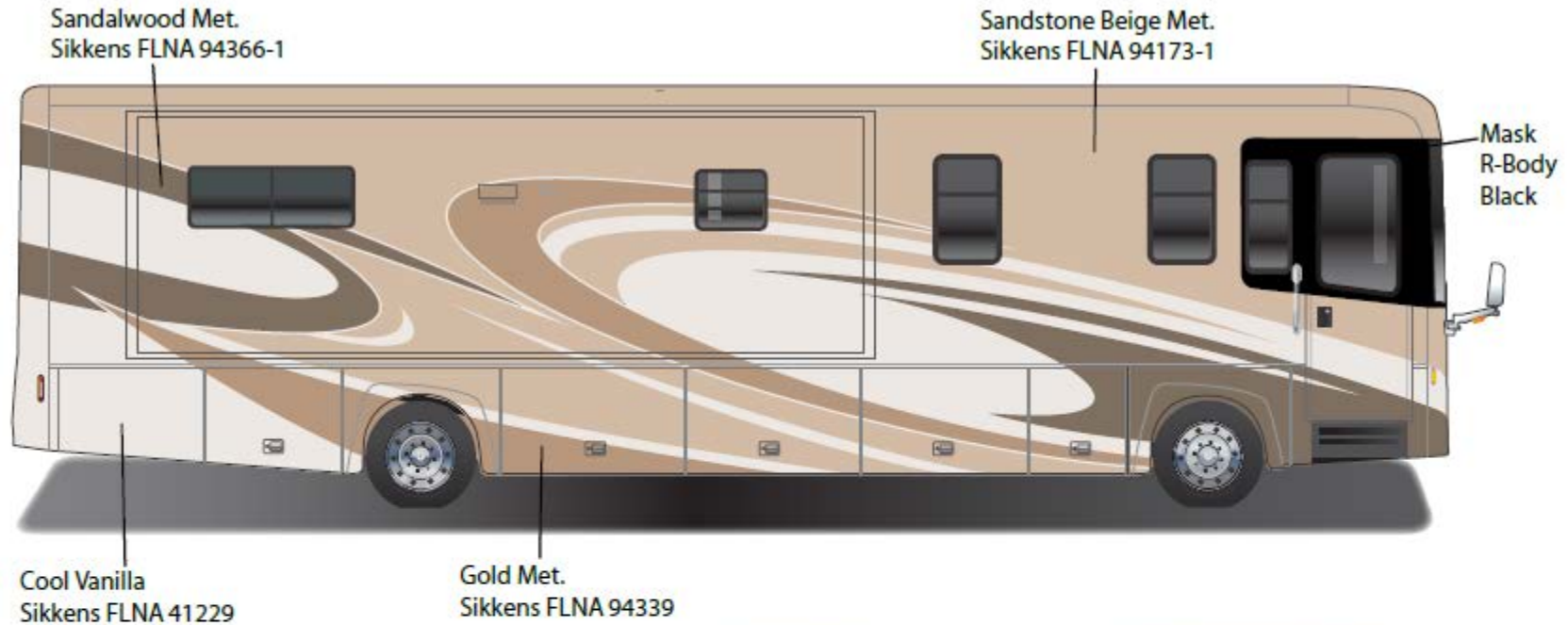

*Full-Body Paint (FBP) is performed by CDI. For information or repair approval specific to CDI paint, excluding transportation damage, contact CDI directly at 641/585-5900.

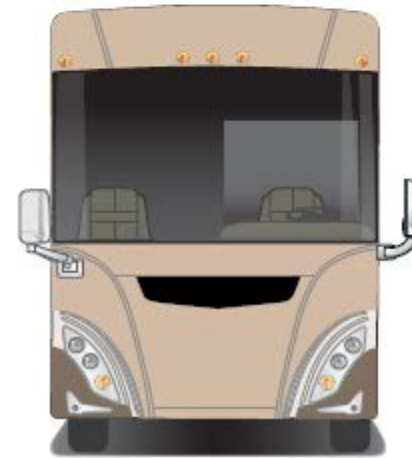

Journey - Full Body Paint Option Code 24L/Desert Canyon

Painted by CDI*

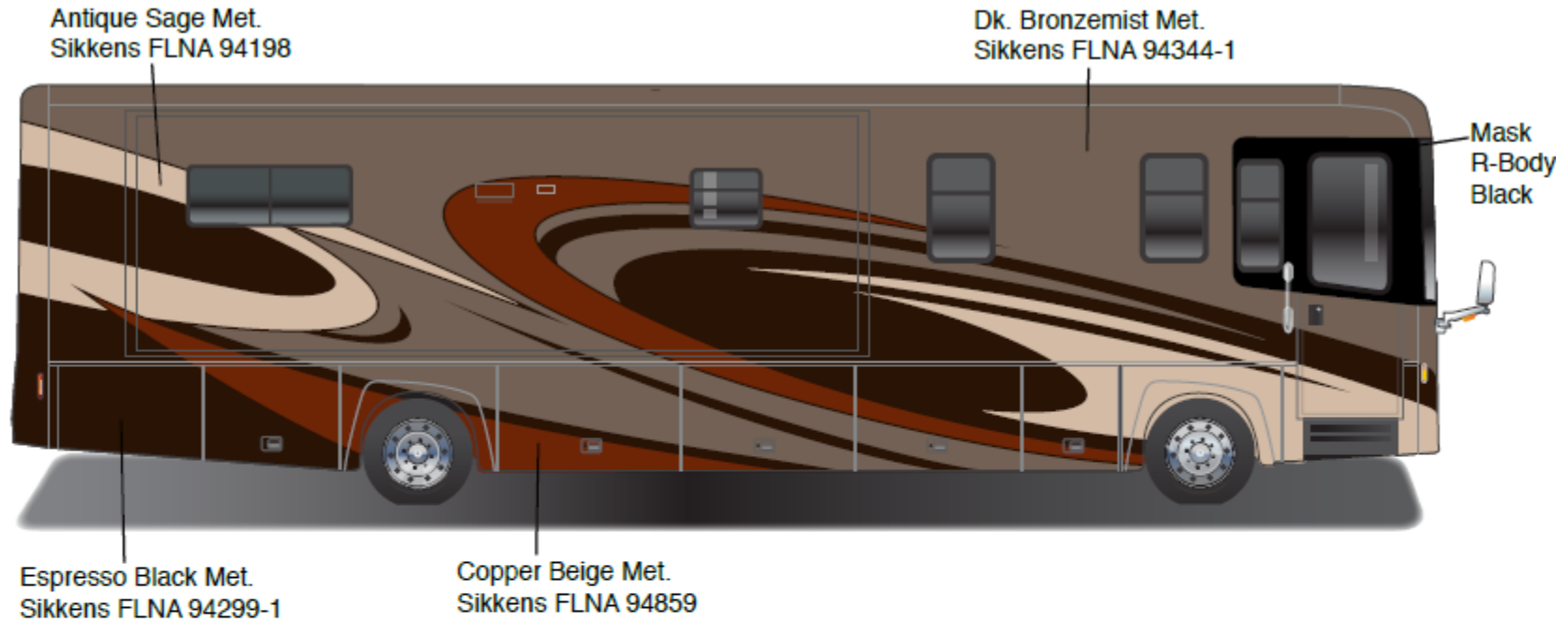

*Full-Body Paint (FBP) is performed by CDI. For information or repair approval specific to CDI paint, excluding transportation damage, contact CDI directly at 641/585-5900.

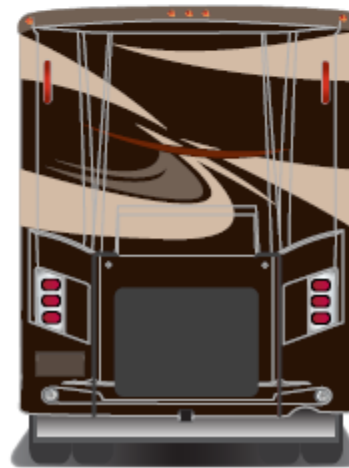

Journey - Full Body Paint Option Code 27A/Light Sandalwood

Painted by CDI*

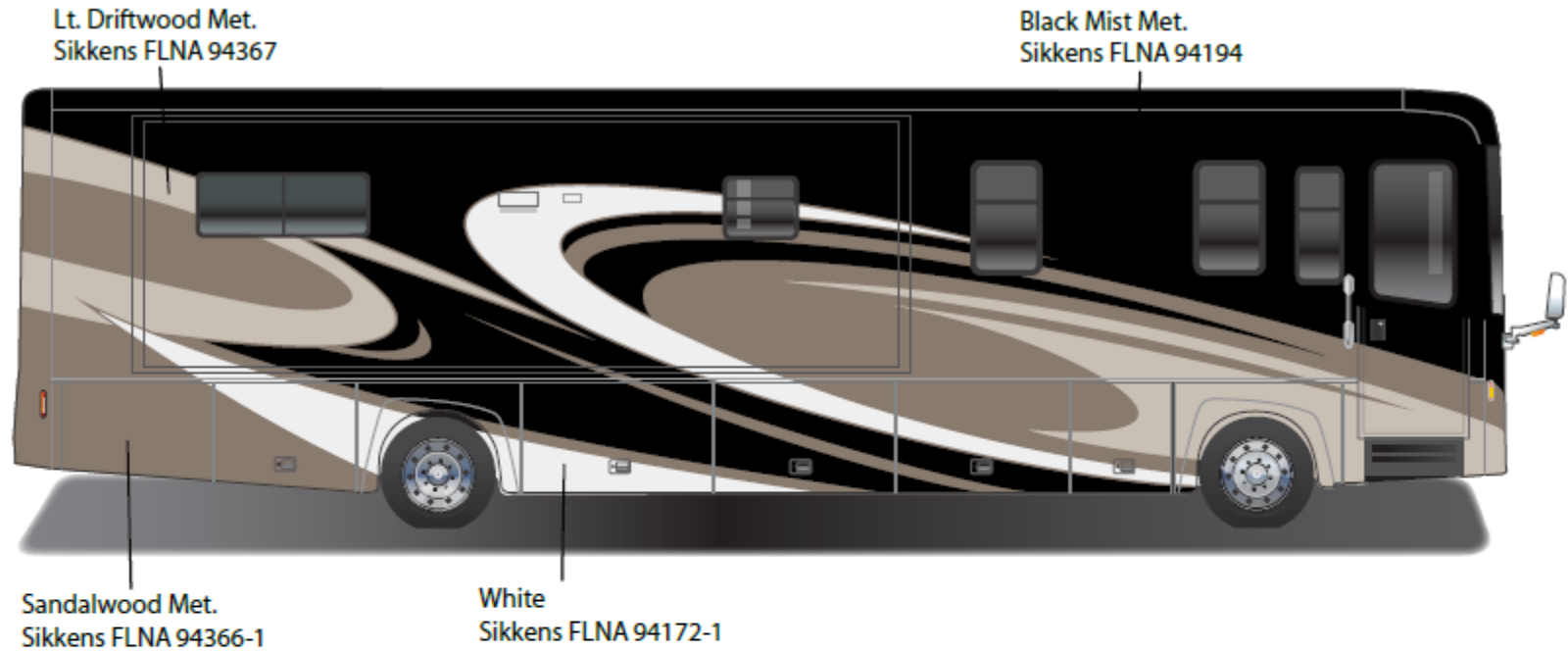

*Full-Body Paint (FBP) is performed by CDI. For information or repair approval specific to CDI paint, excluding transportation damage, contact CDI directly at 641/585-5900.



Journey - Full Body Paint Option Code 92A/Paprika

Painted by CDI*

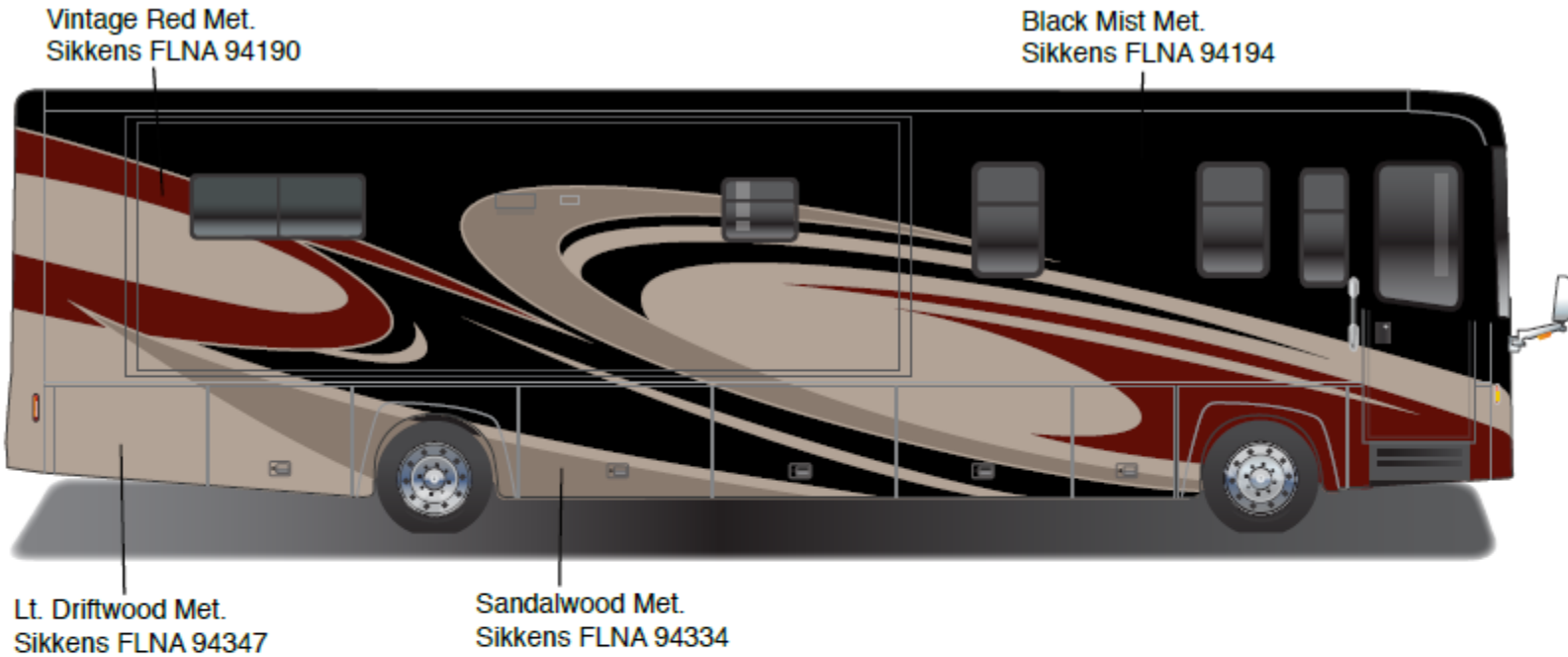

*Full-Body Paint (FBP) is performed by CDI. For information or repair approval specific to CDI paint, excluding transportation damage, contact CDI directly at 641/585-5900.

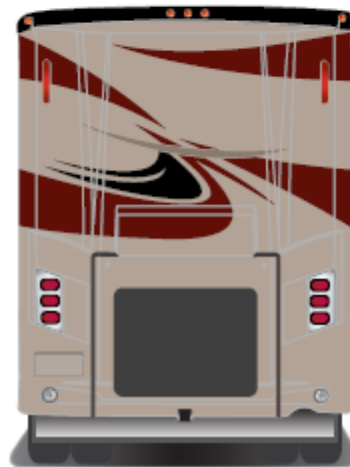

Tour - Full Body Paint Option Code 95C/Spiral Gray

Painted by CDI*

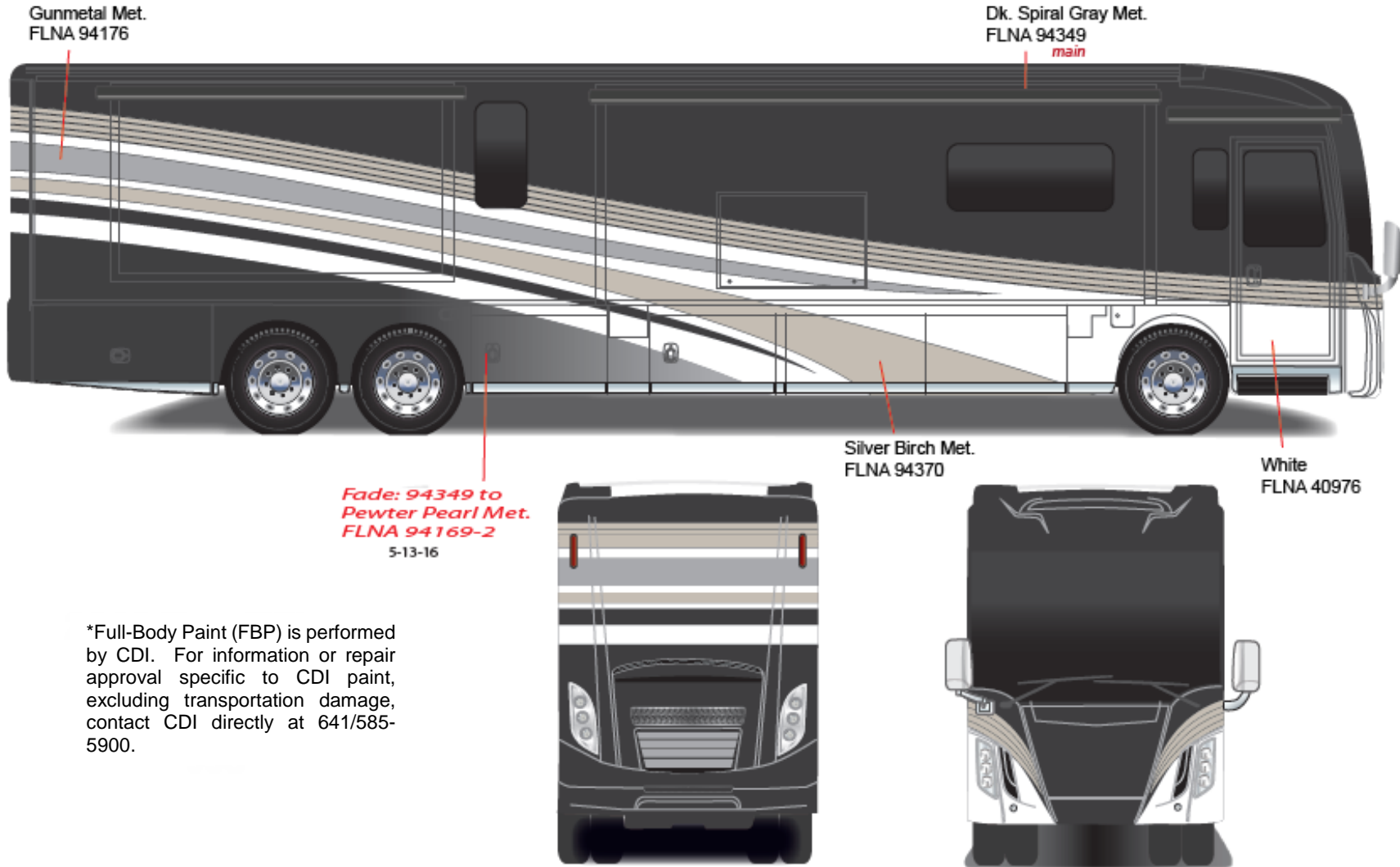

*Full-Body Paint (FBP) is performed by CDI. For information or repair approval specific to CDI paint, excluding transportation damage, contact CDI directly at 641/585-5900.

Tour - Full Body Paint Option Code 95E/Platinum

Painted by CDI*

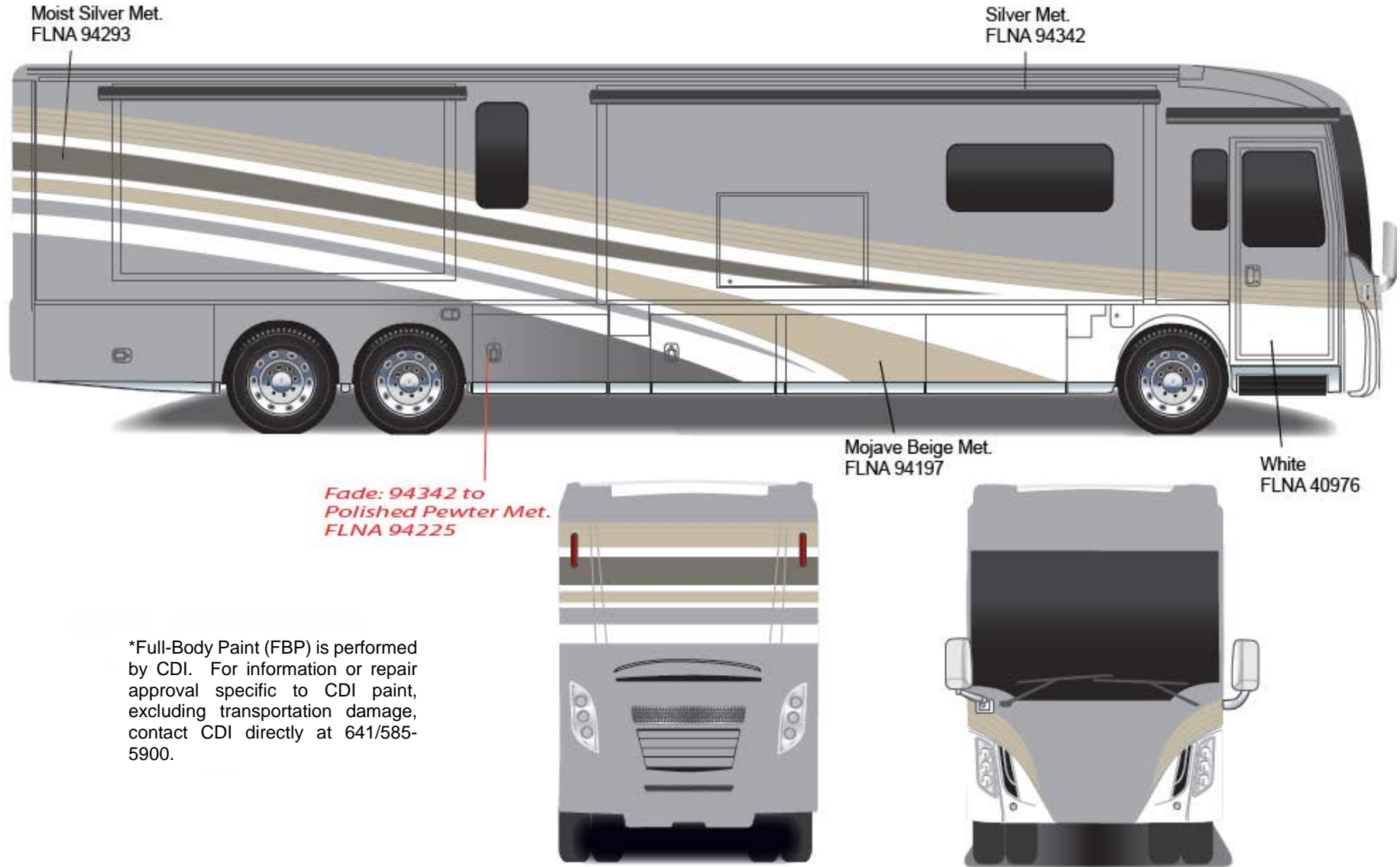

Tour - Full Body Paint Option Code 95F/Shiraz

Painted by CDI*

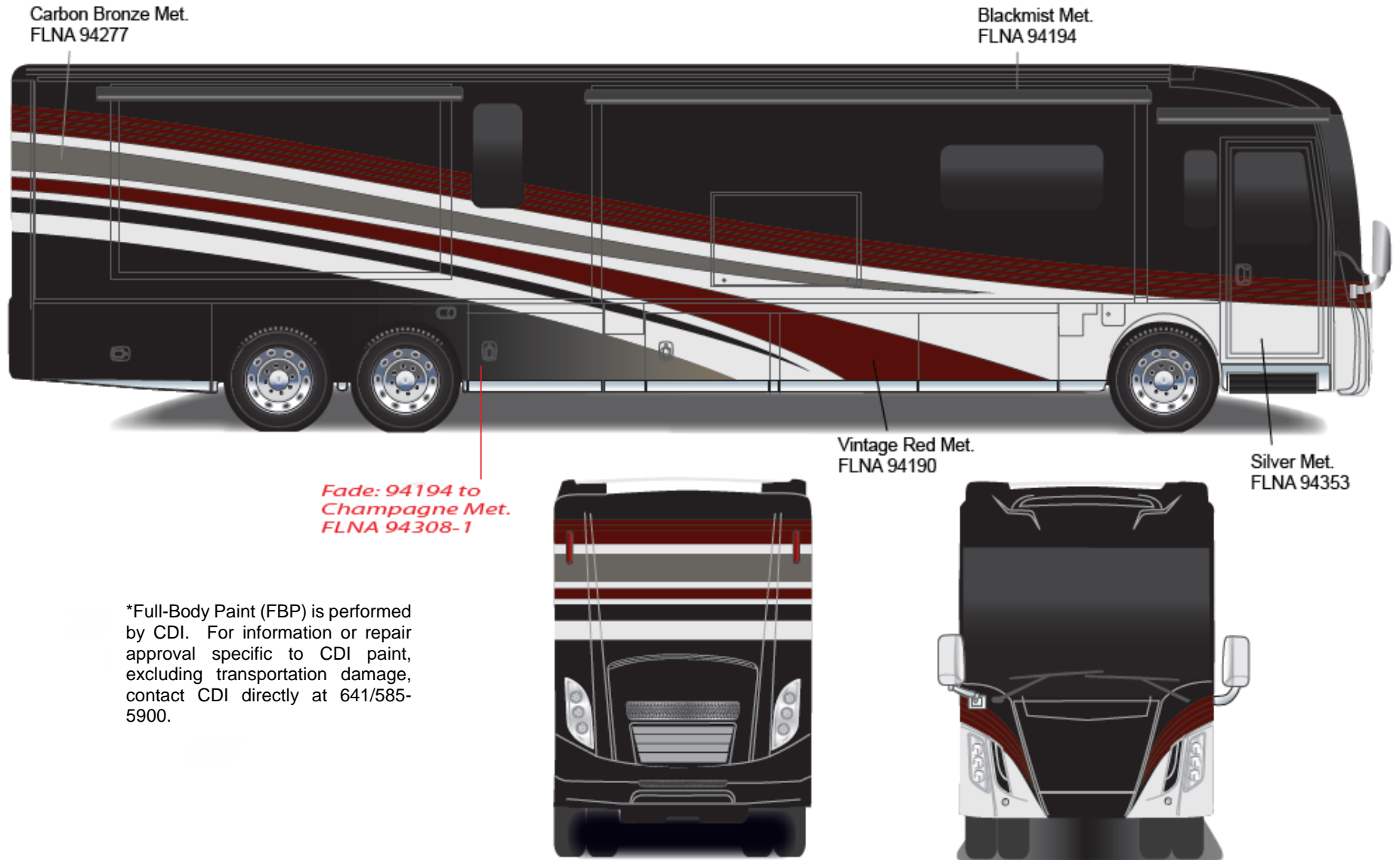

*Full-Body Paint (FBP) is performed by CDI. For information or repair approval specific to CDI paint, excluding transportation damage, contact CDI directly at 641/585-5900.

Tour - Full Body Paint Option Code 95G/Autumn Frost

Painted by CDI*

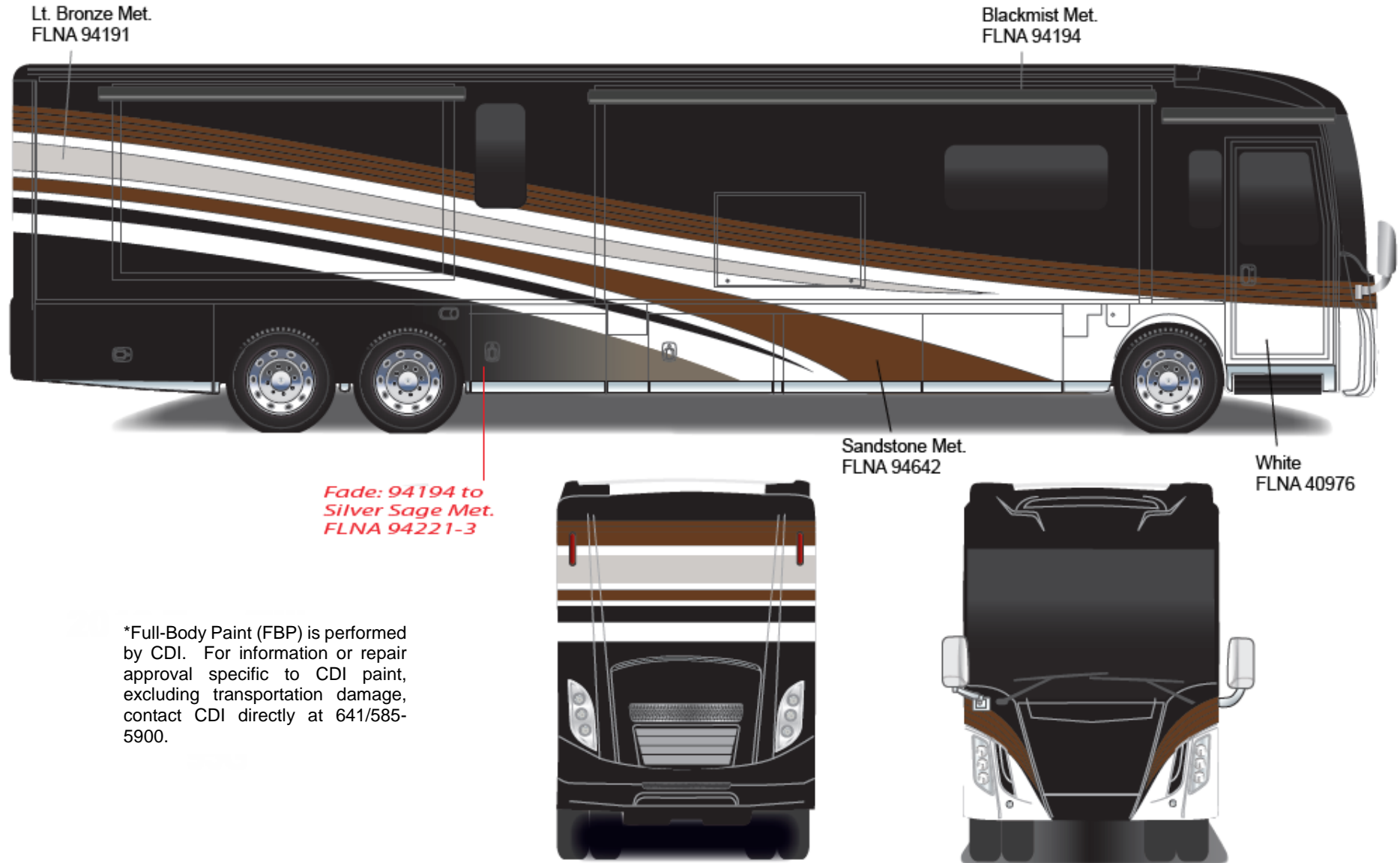

*Full-Body Paint (FBP) is performed by CDI. For information or repair approval specific to CDI paint, excluding transportation damage, contact CDI directly at 641/585-5900.

Tour - Full Body Paint Option Code 95H/Silver Birch

Painted by CDI*

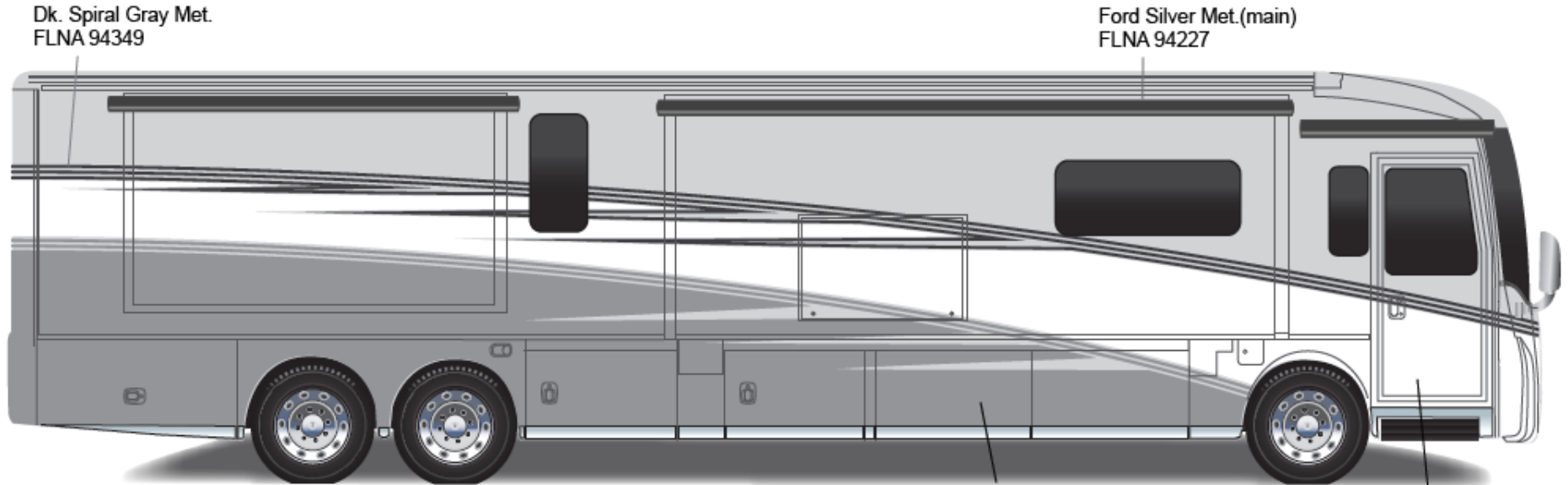

Lt. Spiral Gray Met.
FLNA 94341

White
FLNA 94325

*Full-Body Paint (FBP) is performed by CDI. For information or repair approval specific to CDI paint, excluding transportation damage, contact CDI directly at 641/585-5900.

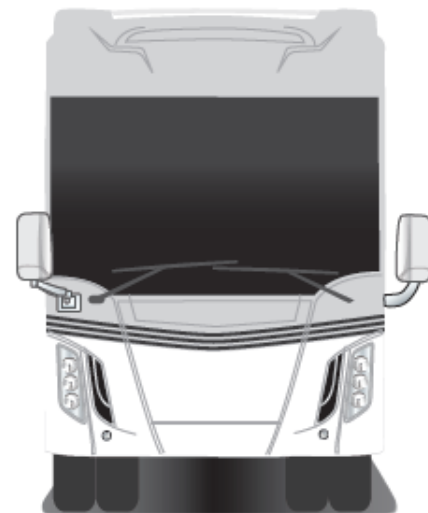

Tour - Full Body Paint Option Code 95J/Garnet

Painted by CDI*



*Full-Body Paint (FBP) is performed by CDI. For information or repair approval specific to CDI paint, excluding transportation damage, contact CDI directly at 641/585-5900.

Tour - Full Body Paint Option Code 95K/Crimson

Painted by CDI*

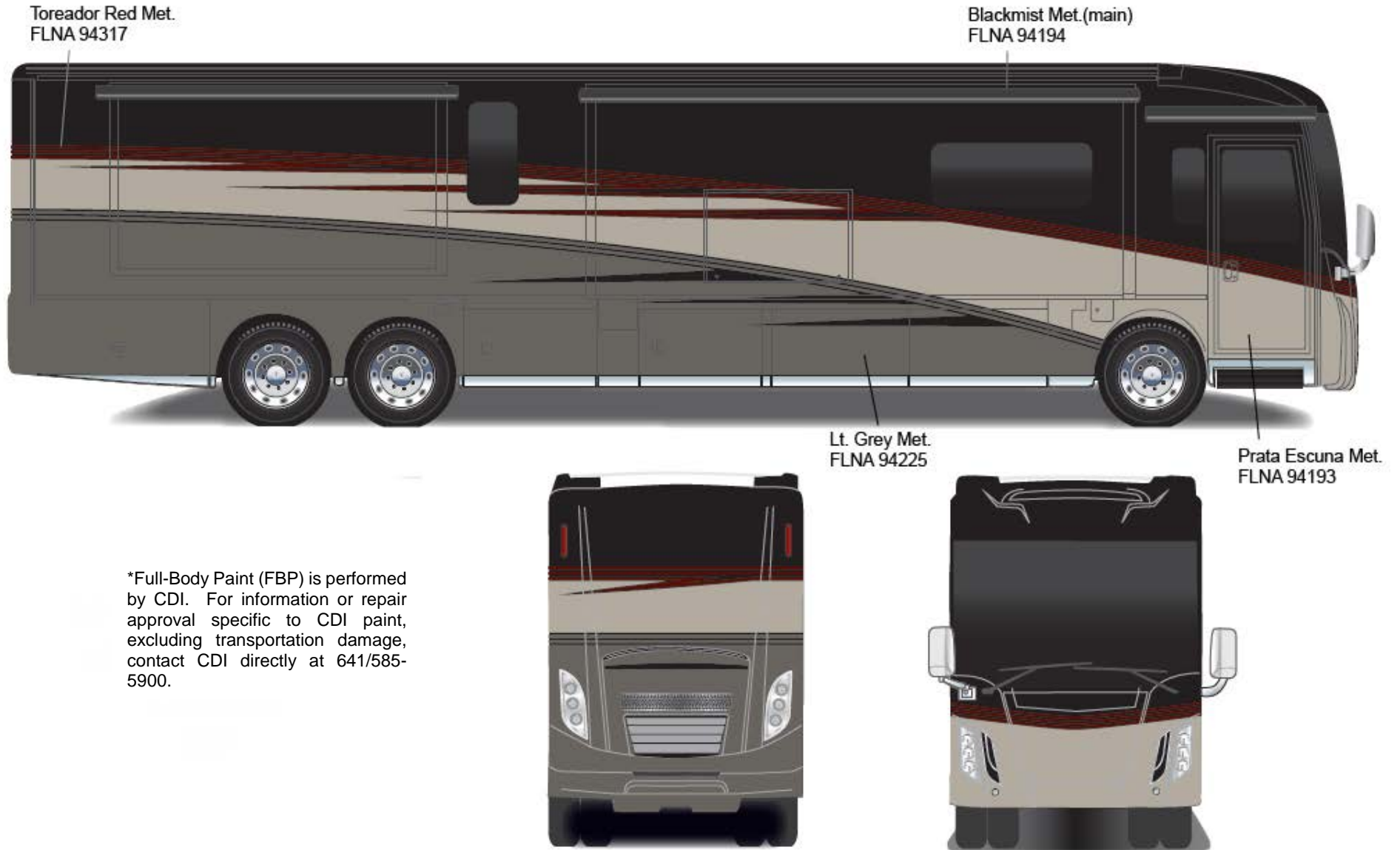

*Full-Body Paint (FBP) is performed by CDI. For information or repair approval specific to CDI paint, excluding transportation damage, contact CDI directly at 641/585-5900.

Tour - Full Body Paint Option Code 95M/Azure

Painted by CDI*

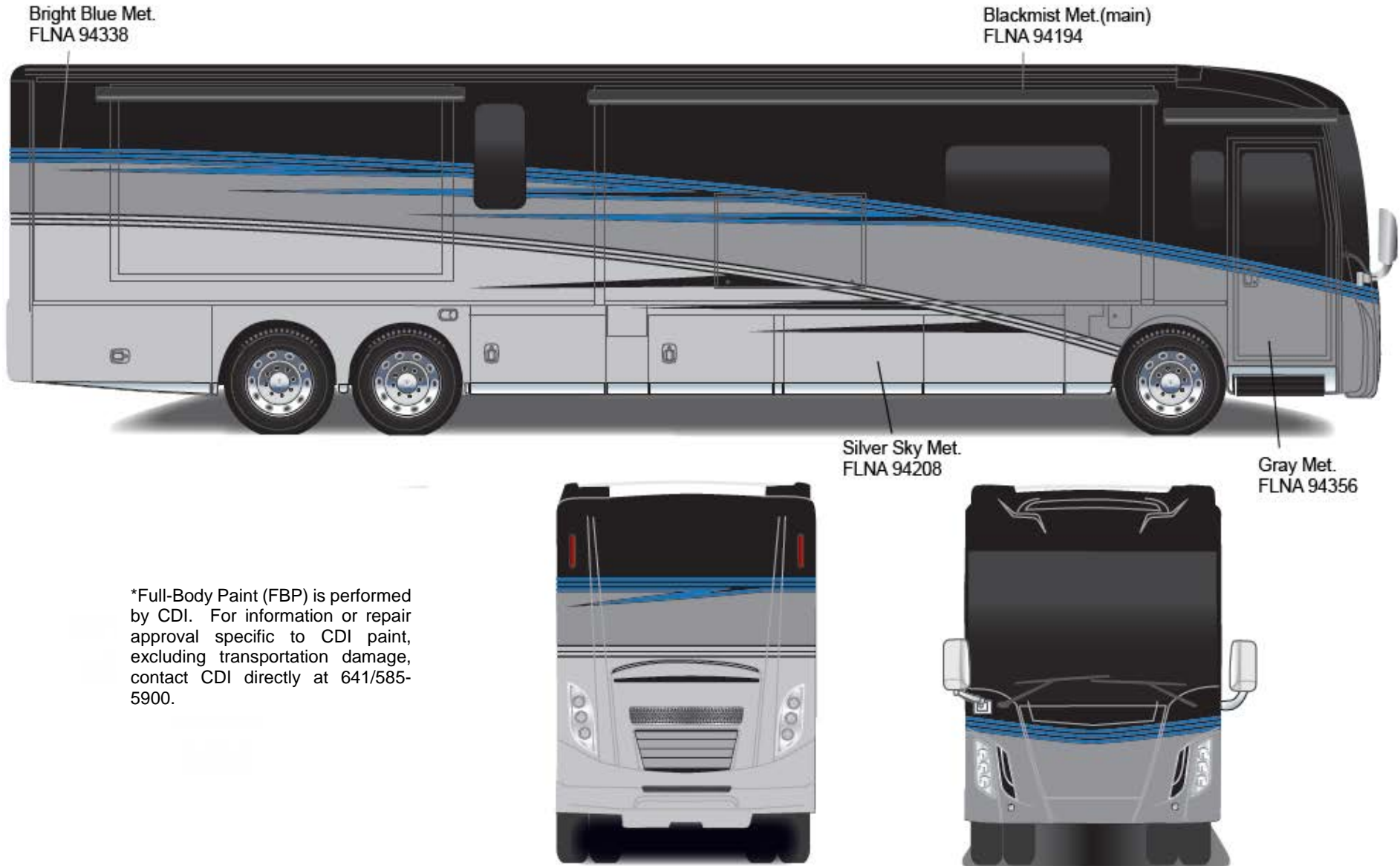

*Full-Body Paint (FBP) is performed by CDI. For information or repair approval specific to CDI paint, excluding transportation damage, contact CDI directly at 641/585-5900.

Grand Tour - Full Body Paint Option Code 24B/Titanium

Painted by CDI*

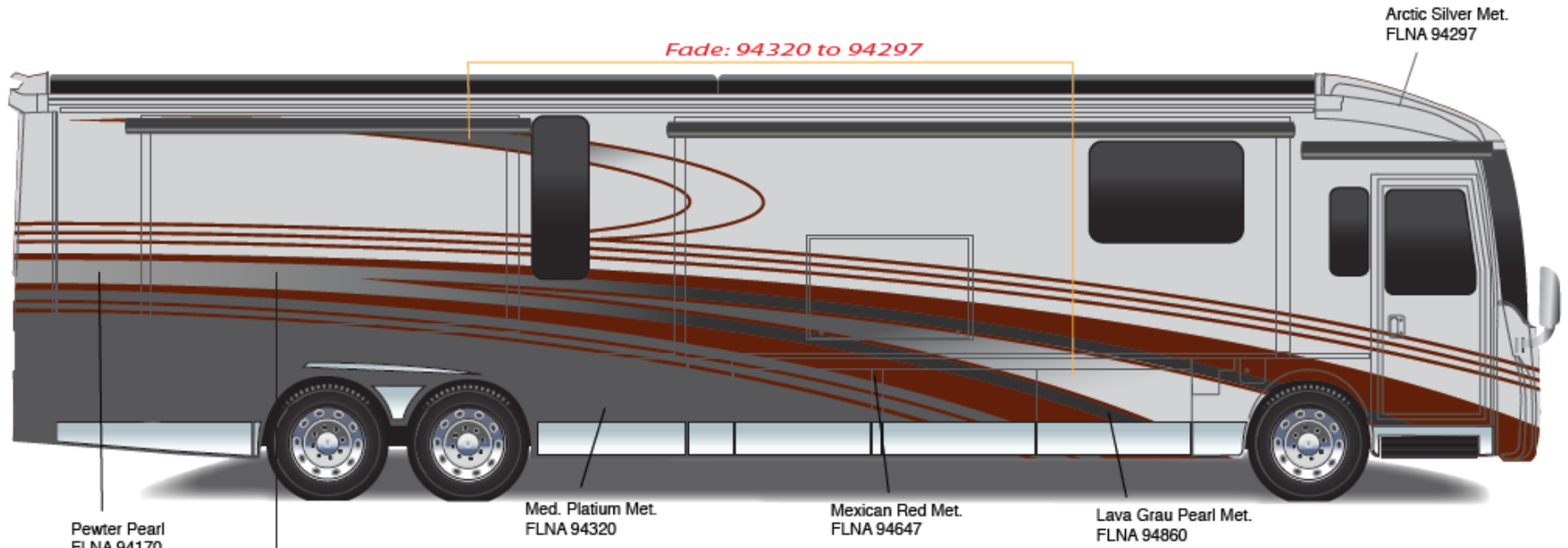

Fade: 94170----94860

*Full-Body Paint (FBP) is performed by CDI. For information or repair approval specific to CDI paint, excluding transportation damage, contact CDI directly at 641/585-5900.

Fade: 94170----94860 to 94170

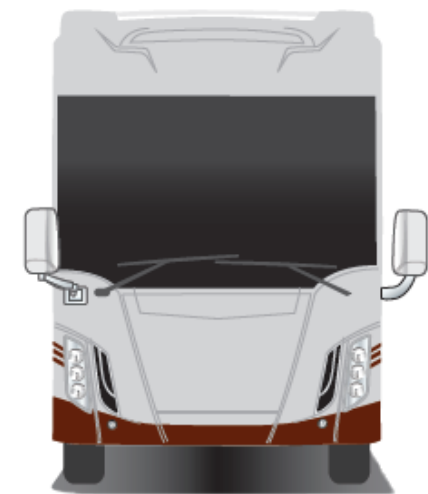

Grand Tour - Full Body Paint Option Code 24C/Bordeaux

Painted by CDI*

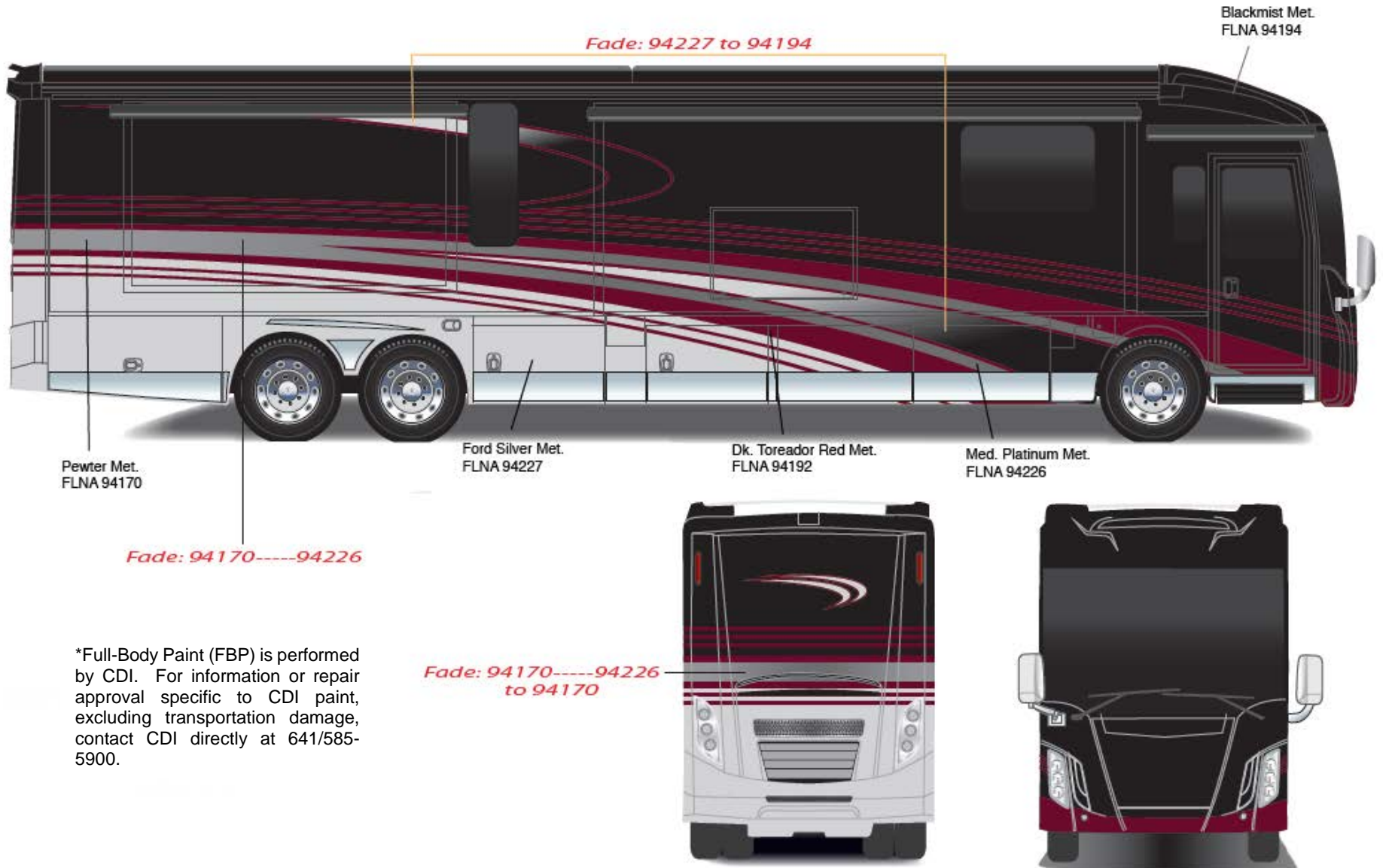

*Full-Body Paint (FBP) is performed by CDI. For information or repair approval specific to CDI paint, excluding transportation damage, contact CDI directly at 641/585-5900.

Grand Tour - Full Body Paint Option Code 24H/Sunray

Painted by CDI*

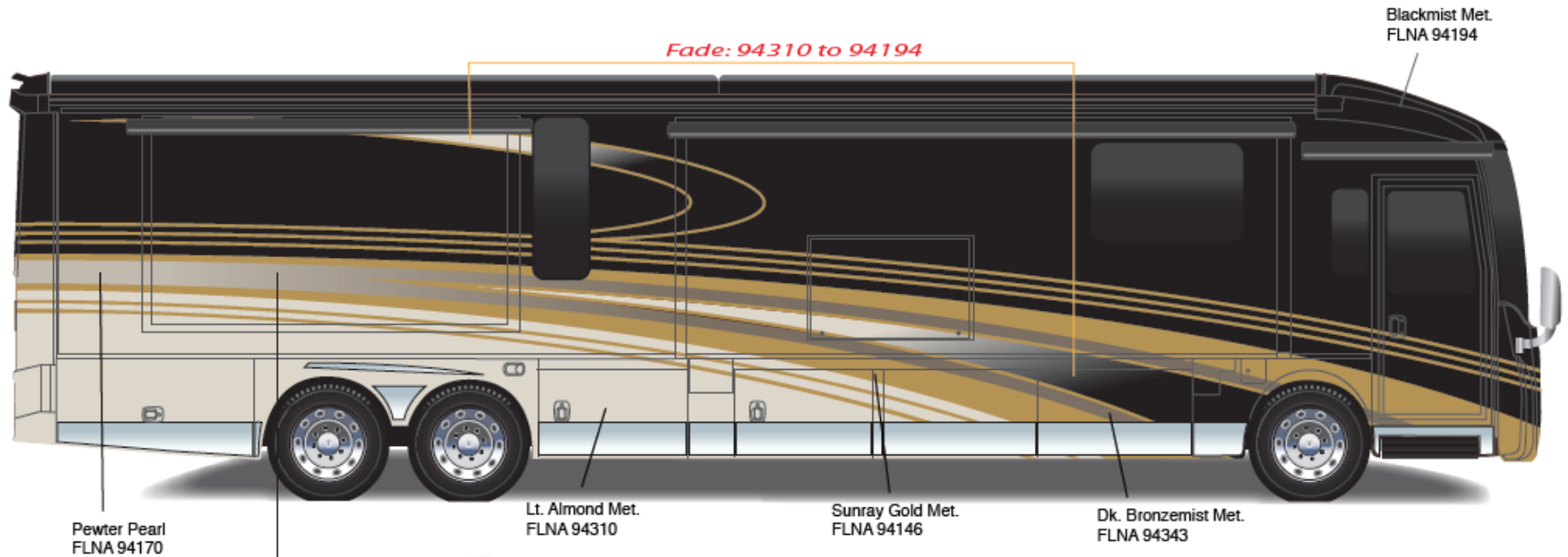

Fade: 94221-----94343

*Full-Body Paint (FBP) is performed by CDI. For information or repair approval specific to CDI paint, excluding transportation damage, contact CDI directly at 641/585-5900.

Fade: 94221-----94343 to 94221

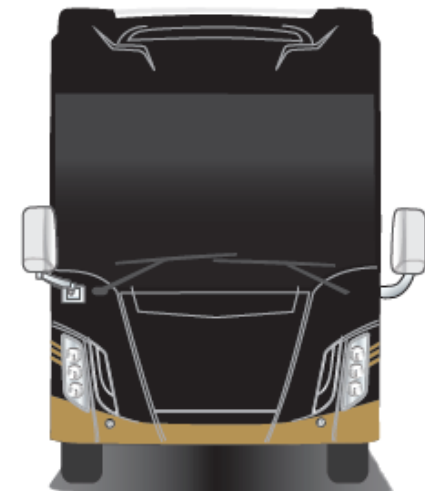

Grand Tour - Full Body Paint Option Code 24L/Autumn Frost

Painted by CDI*

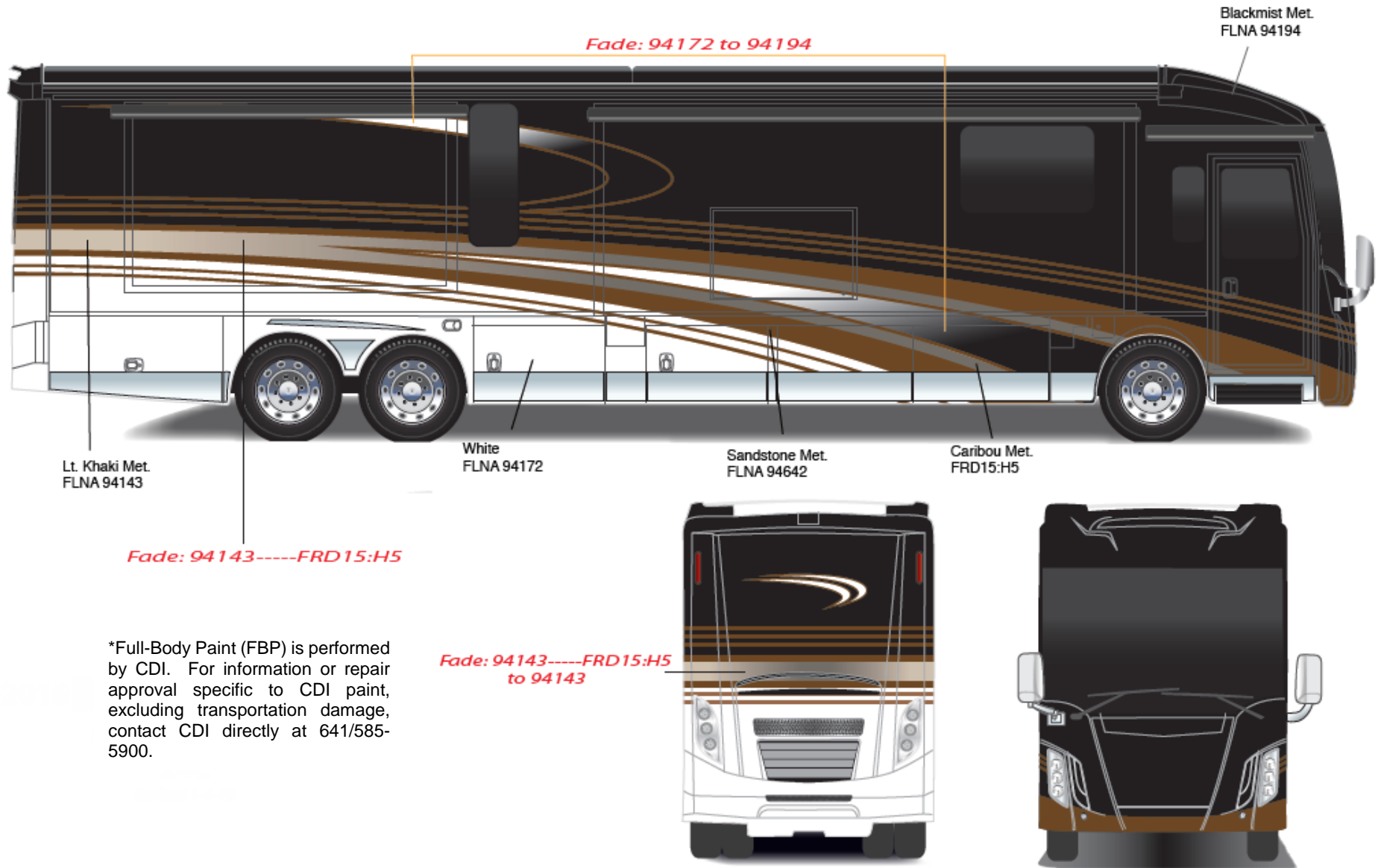

*Full-Body Paint (FBP) is performed by CDI. For information or repair approval specific to CDI paint, excluding transportation damage, contact CDI directly at 641/585-5900.

Grand Tour - Full Body Paint Option Code 24M/Solar Sand

Painted by CDI*



Gray Brown Met. (main)
353D4

White Met.
FLNA 94172

Arizona Beige Met.
353G5

Fade
Bold Beige Met. FLNA 94659 to
Pewter Brown Met. 353A5

*Full-Body Paint (FBP) is performed by CDI. For information or repair approval specific to CDI paint, excluding transportation damage, contact CDI directly at 641/585-5900.



Grand Tour - Full Body Paint Option Code 27A/Solar Winds

Painted by CDI*

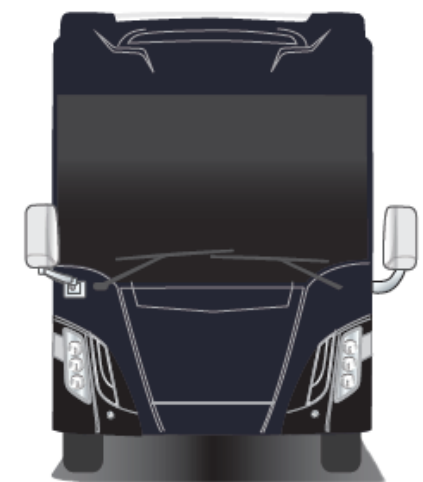
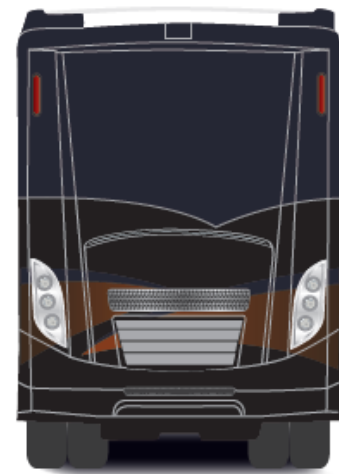
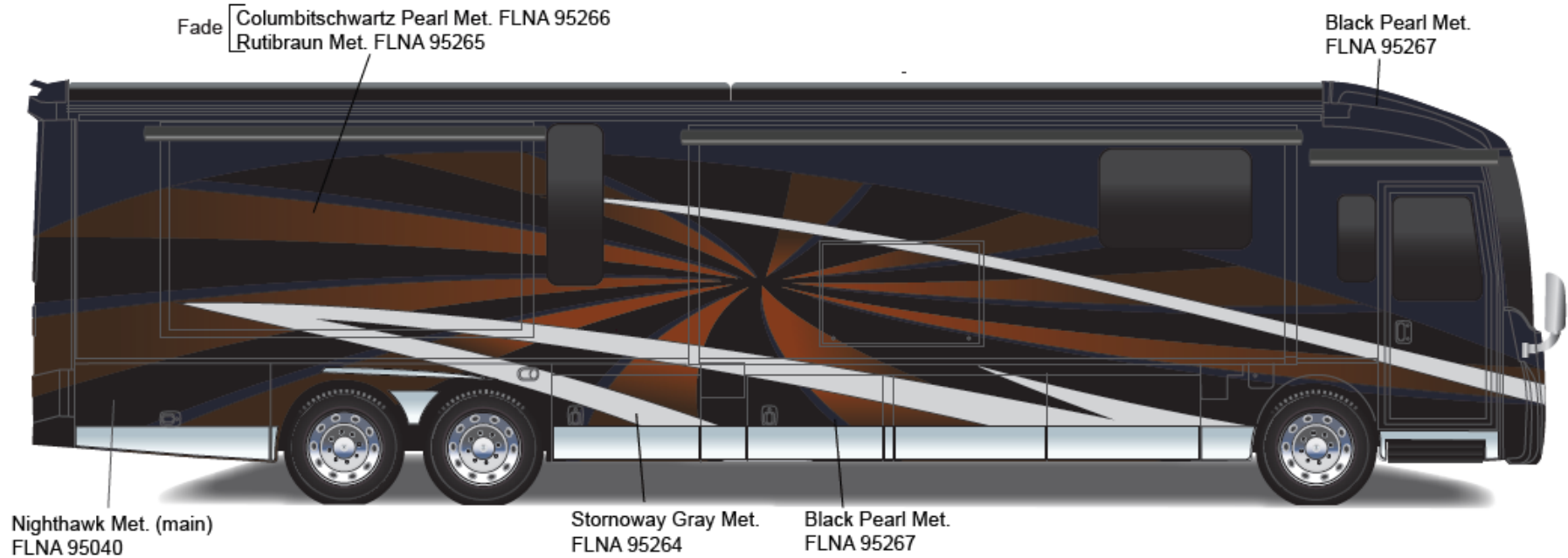

*Full-Body Paint (FBP) is performed by CDI. For information or repair approval specific to CDI paint, excluding transportation damage, contact CDI directly at 641/585-5900.

Grand Tour - Full Body Paint Option Code 92A/Solar Stone

Painted by CDI*

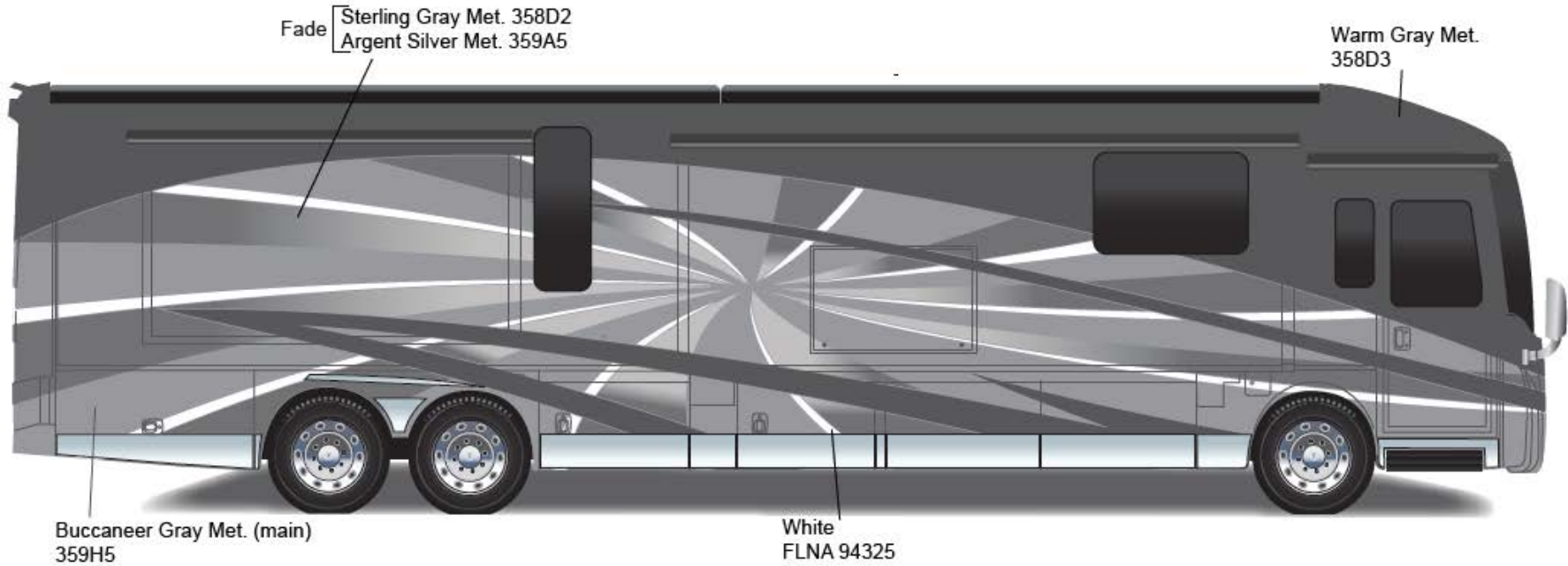

*Full-Body Paint (FBP) is performed by CDI. For information or repair approval specific to CDI paint, excluding transportation damage, contact CDI directly at 641/585-5900.

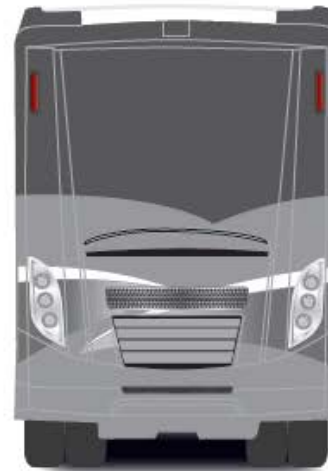

Grand Tour - Full Body Paint Option Code 95C/Beachwood

Painted by CDI*

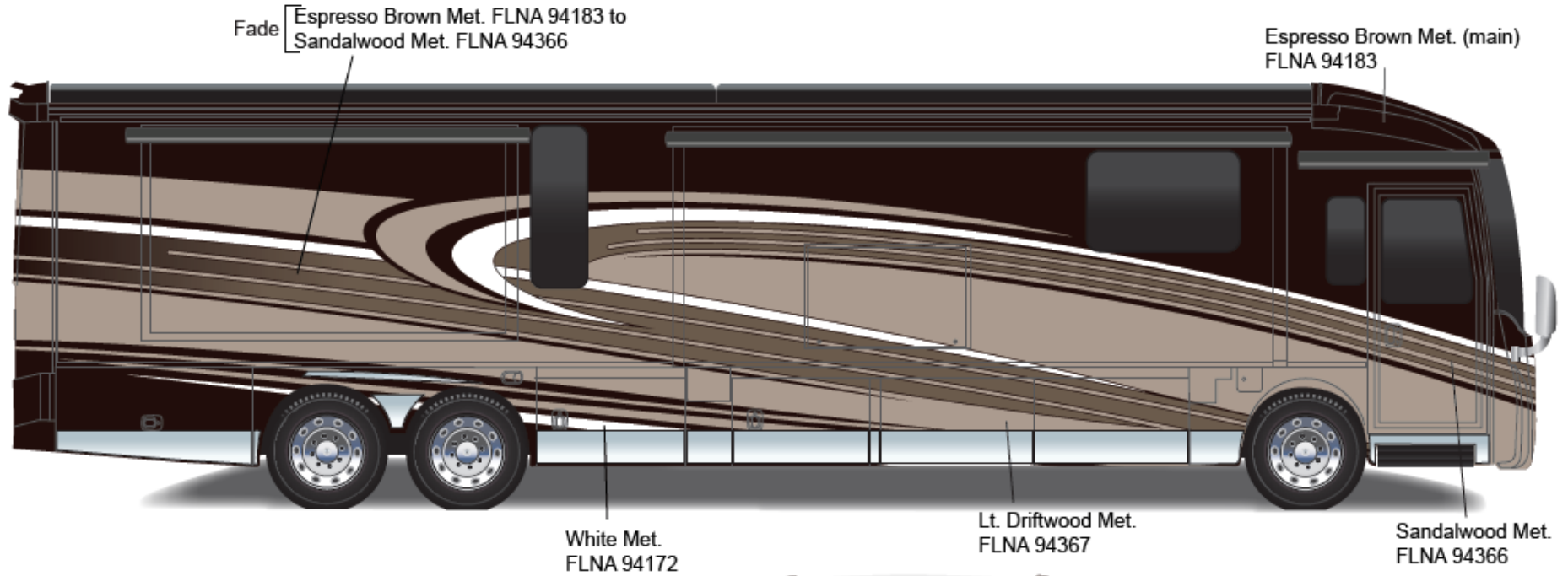

Fade:
94183 to 94366 to 94183

*Full-Body Paint (FBP) is performed by CDI. For information or repair approval specific to CDI paint, excluding transportation damage, contact CDI directly at 641/585-5900.

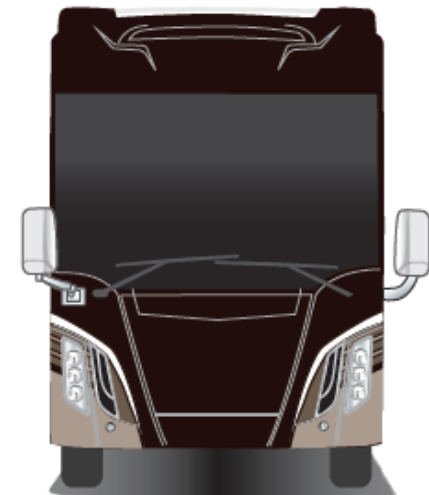
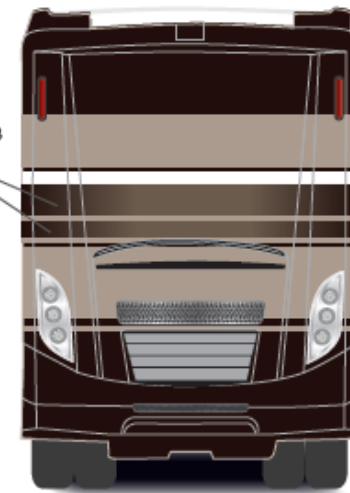

Grand Tour - Full Body Paint Option Code 95E/Spiral Gray

Painted by CDI*

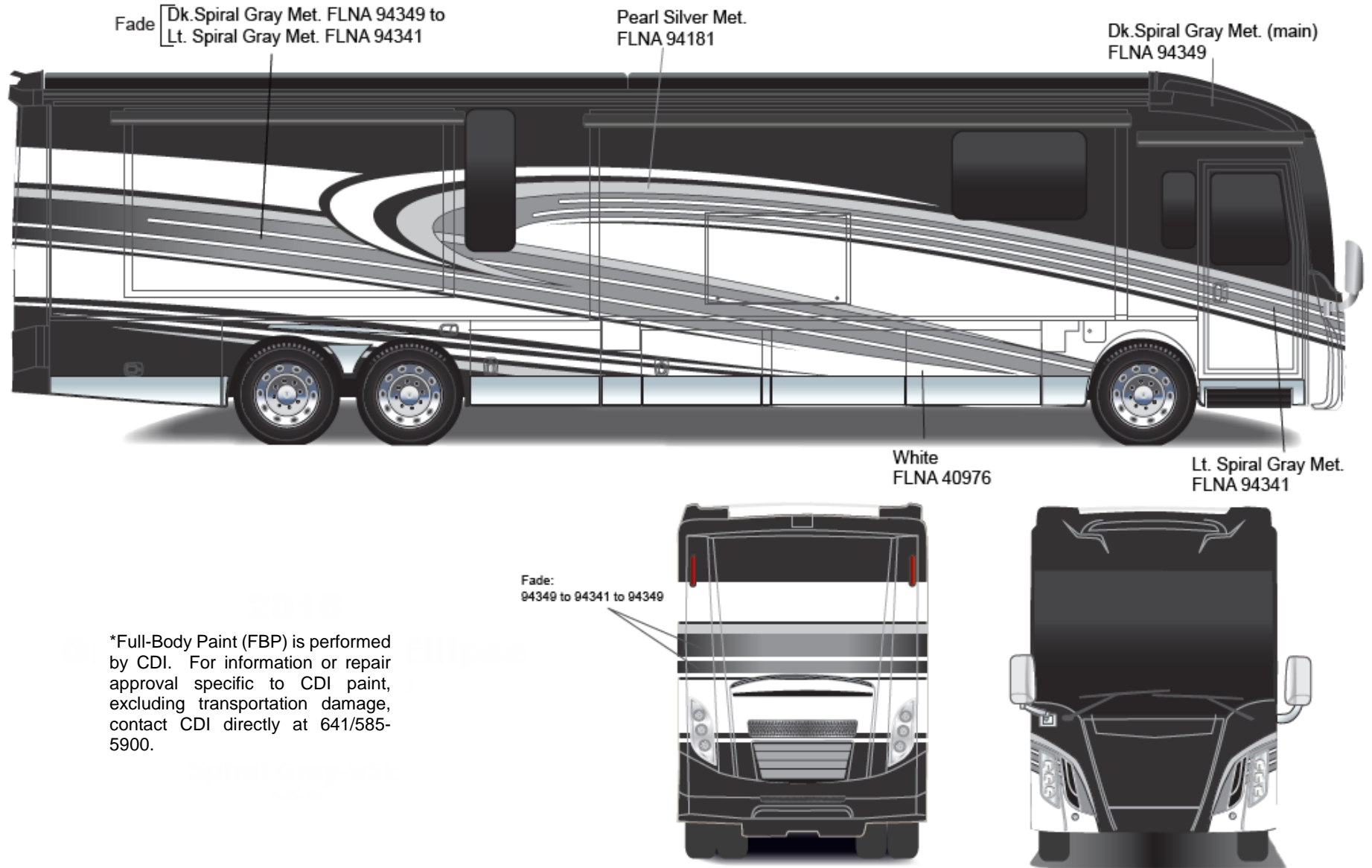

*Full-Body Paint (FBP) is performed by CDI. For information or repair approval specific to CDI paint, excluding transportation damage, contact CDI directly at 641/585-5900.

Grand Tour - Full Body Paint Option Code 95F/Merlot

Painted by CDI*

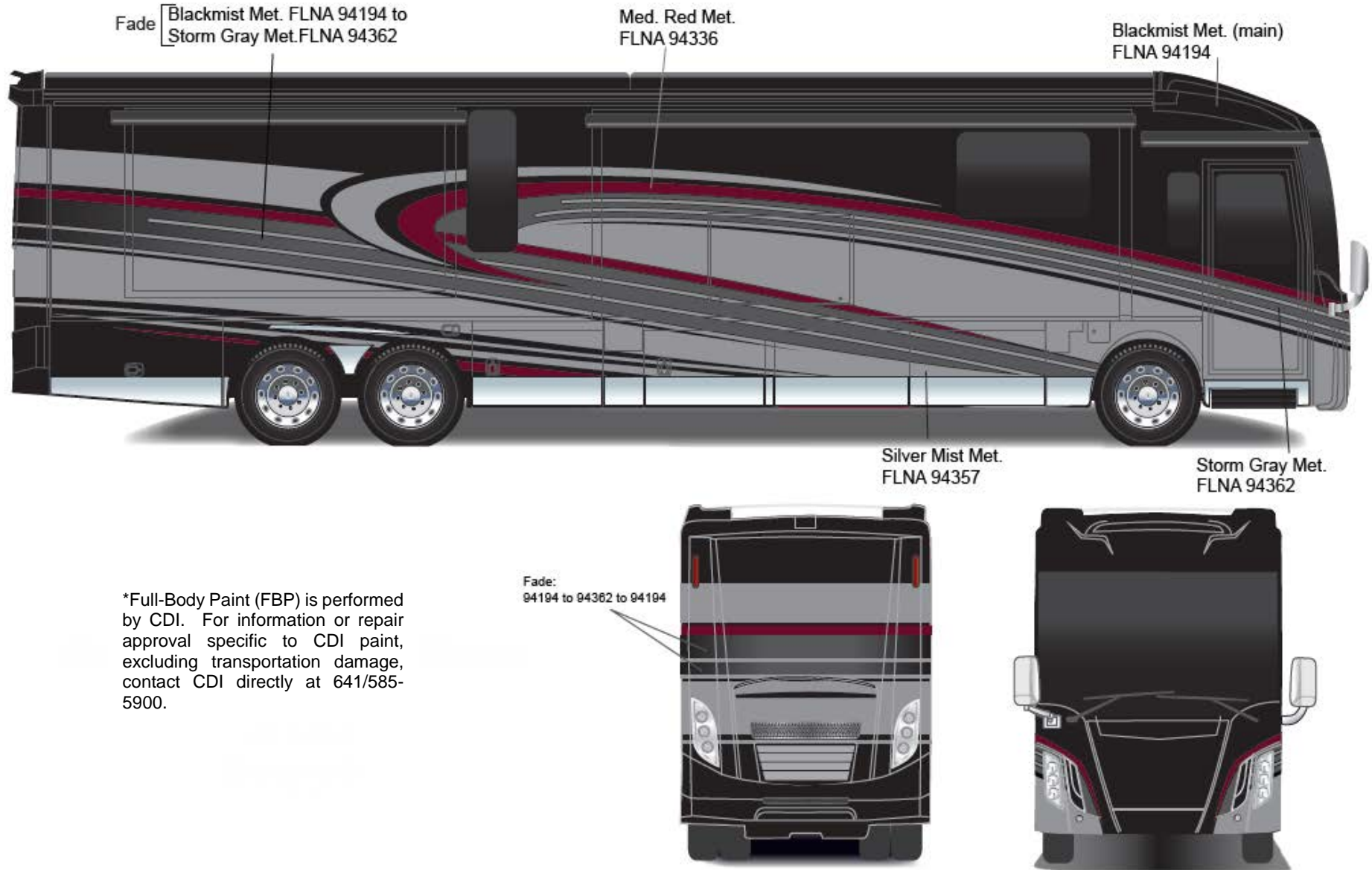

*Full-Body Paint (FBP) is performed by CDI. For information or repair approval specific to CDI paint, excluding transportation damage, contact CDI directly at 641/585-5900.

Grand Tour - Full Body Paint Option Code 95G/Platinum

Painted by CDI*

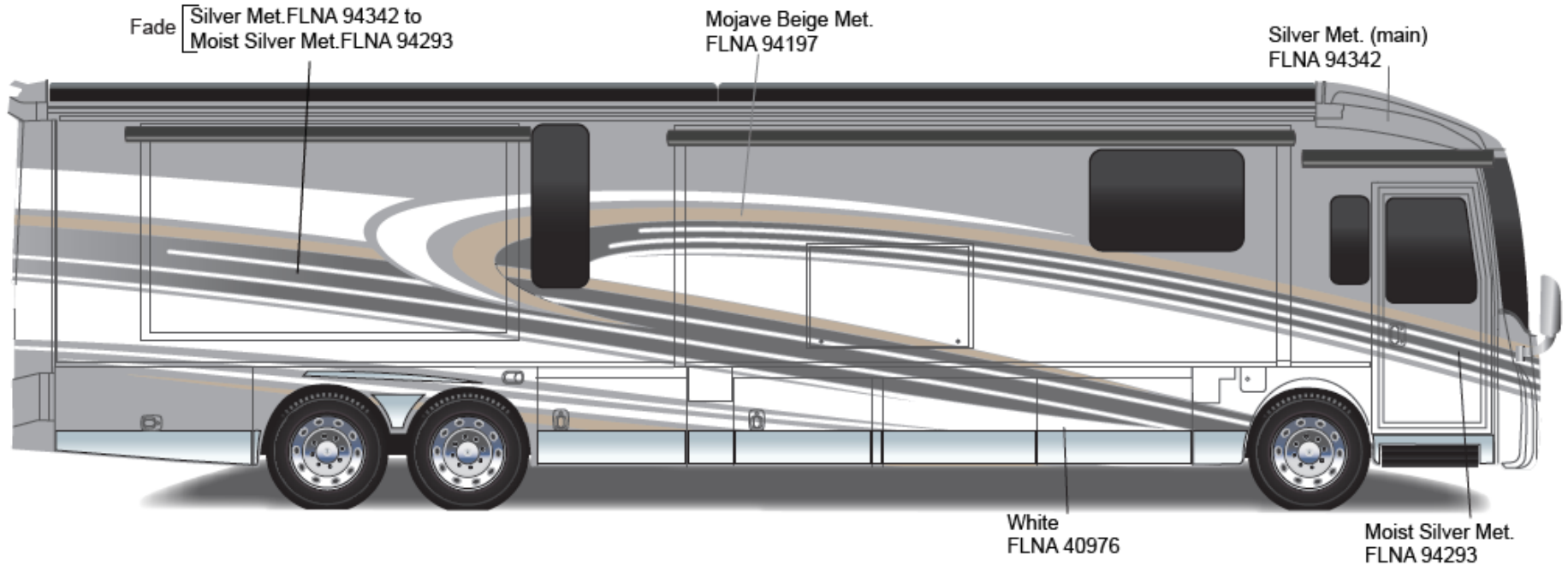

*Full-Body Paint (FBP) is performed by CDI. For information or repair approval specific to CDI paint, excluding transportation damage, contact CDI directly at 641/585-5900.

Fade:
94342 to 94293 to 94342

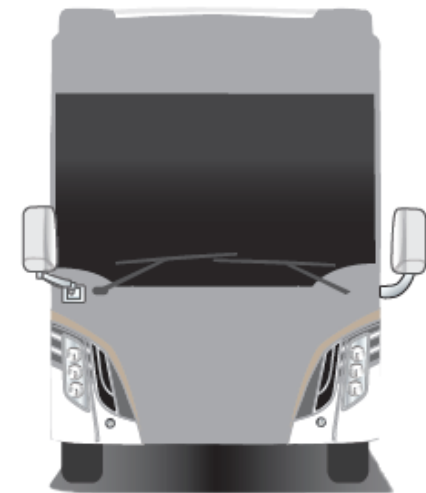
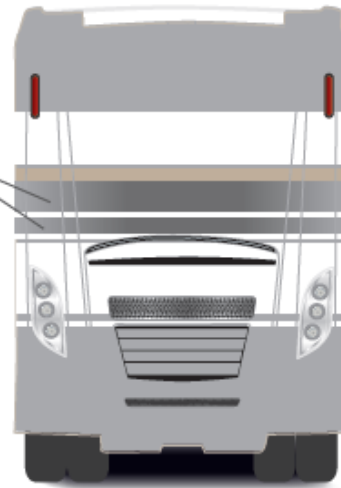

Grand Tour - Full Body Paint Option Code 95H/Dark Spiral Gray

Painted by CDI*

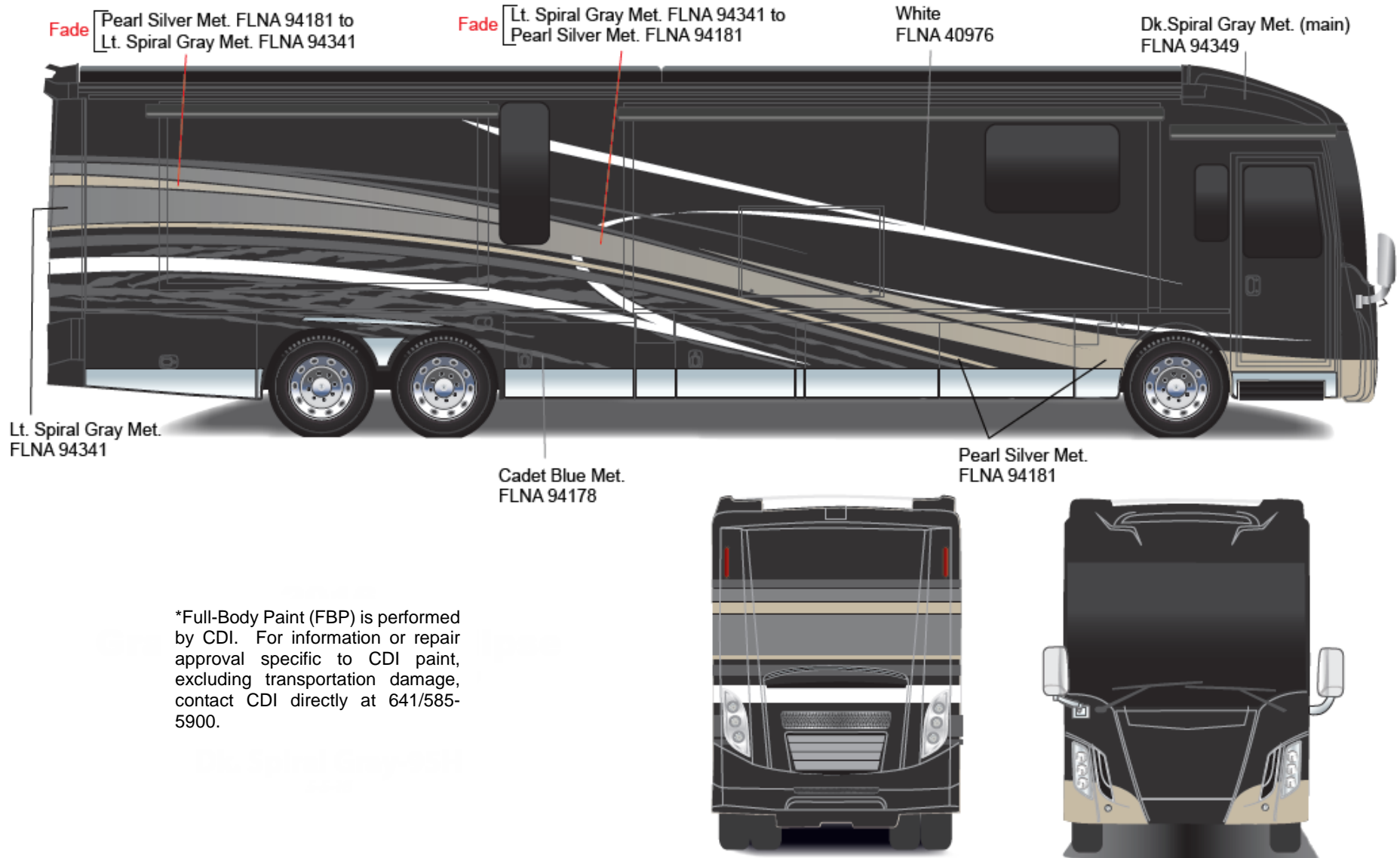

Grand Tour - Full Body Paint Option Code 95J/Sandstone

Painted by CDI*

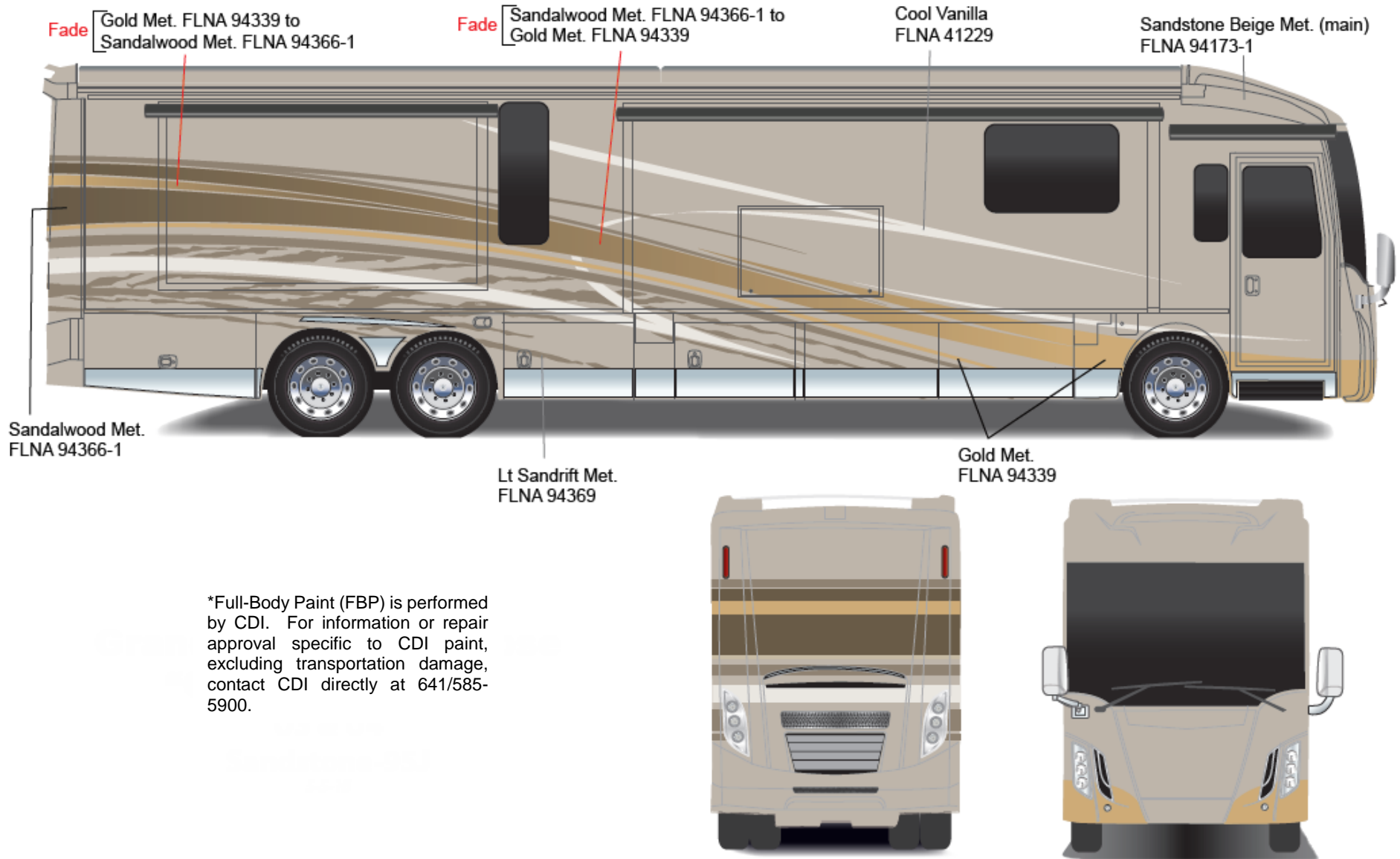

*Full-Body Paint (FBP) is performed by CDI. For information or repair approval specific to CDI paint, excluding transportation damage, contact CDI directly at 641/585-5900.

Grand Tour - Full Body Paint Option Code 95K/Bordeaux

Painted by CDI*

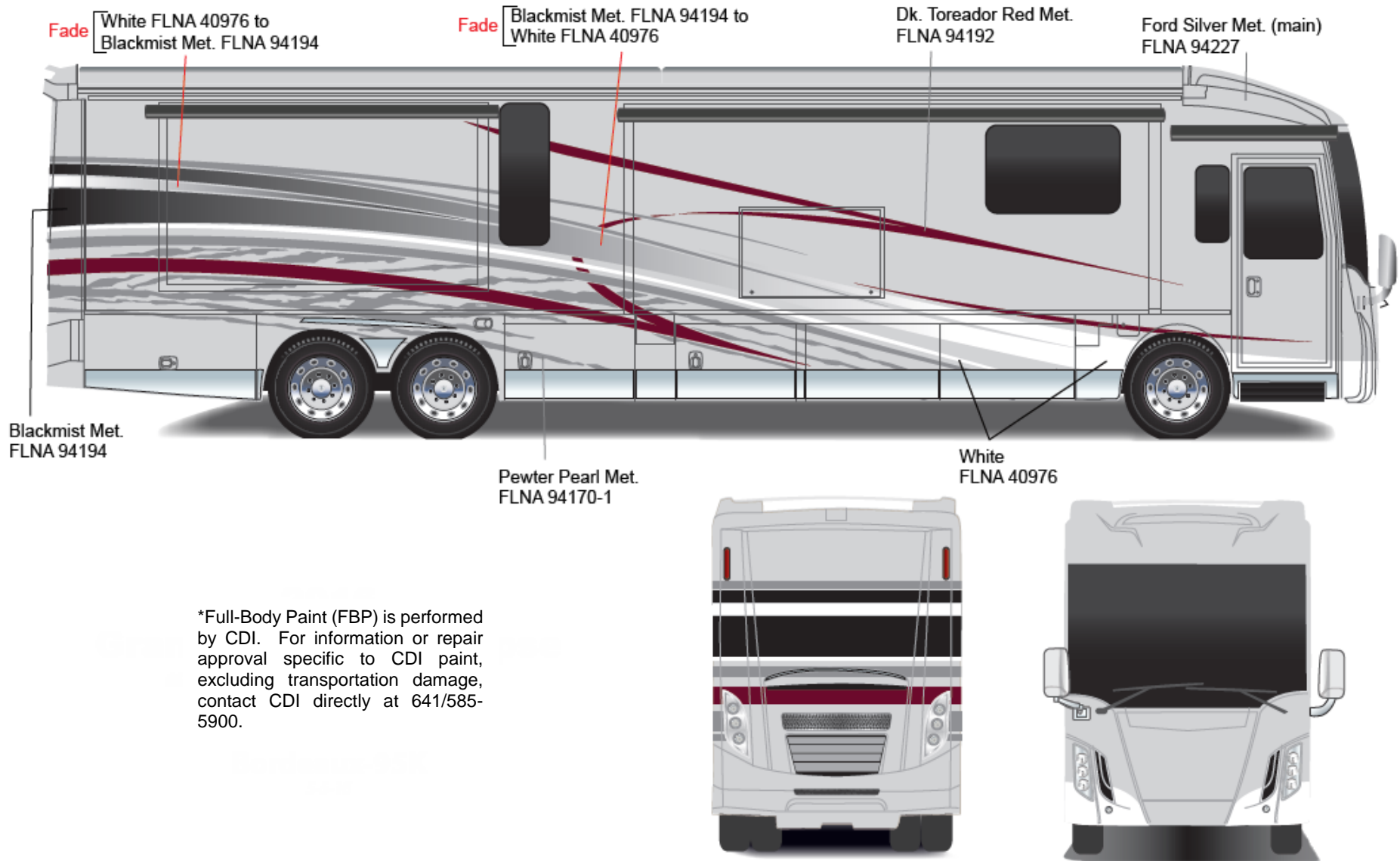

*Full-Body Paint (FBP) is performed by CDI. For information or repair approval specific to CDI paint, excluding transportation damage, contact CDI directly at 641/585-5900.

Grand Tour - Full Body Paint Option Code 95M/Midnight

Painted by CDI*

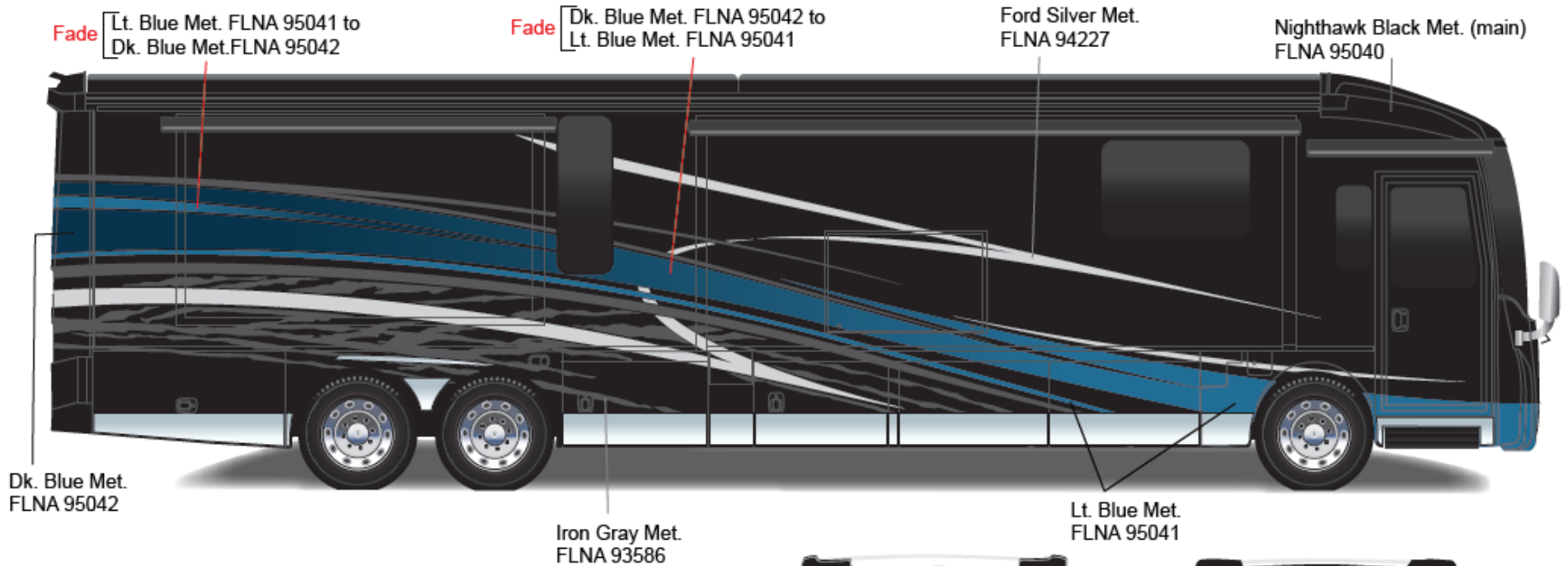

*Full-Body Paint (FBP) is performed by CDI. For information or repair approval specific to CDI paint, excluding transportation damage, contact CDI directly at 641/585-5900.

