

Horizon

TO THE OWNER

Congratulations! We welcome you to the exciting world of motor home travel and camping. You will find it convenient and enjoyable to have all the comforts of home and still enjoy the great outdoors wherever you choose to go.

Your Horizon motor home has been carefully designed, engineered and manufactured to provide dependability as well as safety. Before sliding into the driver's seat, take a few minutes to become familiar with operations and features. This manual was prepared to aid you in the proper care and operation of the vehicle and equipment. We urge you to read it completely. In addition, spend some time with the dealer when you take delivery, you will want to learn all you can about your new motor home.

Your new Horizon motor home is covered by a factory warranty against defects in material and workmanship. This warranty should be validated at once and returned to the factory by your dealer.

Read and understand all instructions and precautions in this manual before operating your new motor home. Throughout this manual, certain items are labeled NOTE, CAUTION and WARNING. These terms alert you to precautions that can involve risk to your vehicle or to your personal safety. Read and follow them carefully.

NOTE: Indicates a special point of information.

CAUTION

Indicates that a failure to observe can cause damage to vehicle or equipment

WARNING

This symbol is used to alert you to precautions that involve your personal safety as well as vehicle damage. Read and follow them carefully.

OWNER'S NAME
STREET ADDRESS
CITY AND STATE (OR PROVINCE IN CANADA)
MOTOR HOME SERIAL NUMBER
VEHICLE CHASSIS IDENTIFICATION NO. (VIN)
DATE OF DELIVERY TO FIRST RETAIL PURCHASER
VEHICLE MILEAGE AT TIME OF DELIVERY
SELLING DEALER NAME AND ADDRESS

TANK CAPACITIES



Diesel Fuel Tank 90 gals. diesel



LP Gas Tank - All Models..... 31 gal. (39 gal. w.c.)



Fresh Water Tank 86 gal.



Water Heater 10 gal.



Black Water Holding Tank
 Models 32TD & 36GD 52 gal.
 Models 34HD & 36LD 48 gal.



Grey Water Holding Tank
 Model 32TD 42 gal.
 Model 34HD & 36LD 52 gal.
 Model 36GD 48 gal.

*LP Gas tank capacity shown is the usable “full” LP gas capacity, which is 80% of the tank manufacturer’s listed water capacity (w.c. shown in parenthesis). An LP tank must have at least 20% of tank volume free to allow for expansion and proper vaporization of the liquid fuel. The tank is also equipped with mandatory safety shut-off equipment that prevents filling above this level.

Horizon

TABLE OF CONTENTS

INTRODUCTION

About This Manual	0-1
Freightliner Chassis Guide.....	0-1
Diesel Engine Manual.....	0-1
Owner's InfoCase	0-2
Options and Equipment	0-2
Before Driving	0-2
Service Assistance	0-2
Warranty	0-2
Drinking and Driving.....	0-2
Reporting Safety Defects.....	0-3
Vehicle Certification Label.....	0-4
Exterior Feature Identification.....	0-5

SECTION 1: SAFETY PRECAUTIONS

General Warnings.....	1-1
Driving	1-1
Fuel & LP Gas	1-2
LP Gas Leaks	1-3
LP Gas Alarm	1-3
Electrical	1-4
Loading	1-4
Maintenance.....	1-4
Formaldehyde Warning.....	1-5
Carbon Monoxide Warning.....	1-5
Carbon Monoxide Alarm	1-5
Emergency Exit Window	1-6
Fire Extinguisher.....	1-7
Smoke Alarm	1-7

SECTION 2: DRIVING YOUR MOTOR

HOME

Before Entering Vehicle.....	2-1
Before Driving Vehicle	2-1
"Key One" Lock System.....	2-2
Fuel Selection	2-2
Fuel Fill.....	2-2
Fuel Tank Capacity	2-2
Starting and Stopping Engine	2-2
Engine Block Heater	2-3
Parking Brake	2-3
Exhaust Braking System	2-4
Hazard Warning Lights	2-4
Door Locks and Handles.....	2-4
Entrance Step	2-5
Entrance Stepwell Cover.....	2-7
Power Mirrors	2-7

Rearview Monitor System	2-9
Electronic Compass/Thermometer	2-9
Remote Controlled Spot/Flood Light	2-10
Seats	2-10
Seat Belts	2-10
Child Restraints.....	2-12
Instrument Panel	2-13
Multi-Function Signal Lever	2-14
Steering Tilt/Telescope	2-14
Cruise Control.....	2-14
Comfort Controls	2-15
Heating.....	2-15
Defrosting	2-15
Ventilation.....	2-15
Air Conditioning.....	2-16
Antenna Check Light.....	2-16
Sound System	2-16
Compact Disc (CD) Changer.....	2-17
Auxiliary Start Switch.....	2-17
Auxiliary Battery Switch	2-17
CB Radio Wiring	2-18
Coach Leveling System	2-18
Slideout Room Extension	2-20
Slideout Room Emergency Crank-in	2-22

SECTION 3: IN CASE OF DRIVING

EMERGENCY

Hazard Flashers.....	3-1
If You Get A Flat Tire.....	3-1
Recovery Towing.....	3-1
Jump Starting	3-2
Connecting a Battery Charger.....	3-3
Engine Overheat	3-3

SECTION 4: TRAVELING WITH YOUR MOTOR HOME

Loading the Vehicle	4-1
Front Axle Tire Alignment	4-1
Weighing Your Loaded Vehicle	4-1
Maximum Occupancy	4-2
Roof Loading	4-2
Car or Trailer Towing	4-2
Pre-Travel Checklist	4-3
Travel Tips	4-3
Severe Weather Information	4-4
Nighttime Driving.....	4-5
Mountain Driving	4-5

Campsite Selection	4-6	Water Purifier System	7-4
Leveling	4-6	Exterior Shower	7-5
Effects of Prolonged Occupancy	4-6	Waste Water System	7-5
Humidity and Condensation	4-6	Dumping Holding Tanks	7-6
SECTION 5: LP GAS SYSTEM		Flushing Black Water Holding Tank	7-6
LP Gas Supply	5-1	Using On-Site Sewer Hook-Ups	7-6
Safe Use of LP Gas System	5-1	Utility Light	7-7
How LP Gas Works	5-1	Water Drain Valves	7-7, 7-8
Selecting Fuel Types	5-2	Holding Tank Capacities	7-9
LP Tank System	5-2	SECTION 8: APPLIANCES AND	
Refilling Tank	5-2	INTERIOR FEATURES	
Air in the LP Gas Tank	5-3	Refrigerators & Ice Makers	8-1 - 8-5
Traveling with LP Gas	5-3	LP Gas Cook Top	8-6
Regulator	5-4	Microwave Convection Oven	8-7
LP Gas Leaks	5-4	Range Hood	8-7
Winter Use of LP Gas	5-5	OnePlace Monitor Panel	8-7
SECTION 6: ELECTRICAL SYSTEMS		Tank Levels, Checking	8-8
110-Volt AC System	6-1	Water Pump Switch	8-8
External Power Cord (Shoreline)	6-1	Battery Voltage Meter	8-9
Connecting the Shoreline	6-2	Washer-Dryer	8-9
PowerLine Energy Management		Water Heater	8-10
System	6-3	Water Heater By-Pass Valve	8-13
Power Converter System	6-3	LP Gas Furnace	8-13
110-Volt Circuit Breakers	6-4	Thermostat	8-13
Charging Section	6-4	Heat Pump	8-15
Thermal Overload Protector	6-4	Central Air Conditioner	8-16
110-Volt Receptacles (Outlets)	6-5	Air Conditioner Filter	8-16
Ground Fault Circuit Interrupter		TV Antenna	8-17
(GFCI)	6-5	TV Signal Amplifier	8-17, 8-18
Auxiliary 110-Volt Generator		Video Selector System	8-18
Operating Instructions	6-6, 6-7	Digital Satellite System	8-18
12-Volt DC System	6-8	Exterior Entertainment Center	8-19
12-Volt Fuses and Circuit Breakers	6-8	Cable TV Hook-Up	8-19, 8-20
Solar Charger Panel	6-8	Bedroom Radio	8-20
Battery Information	6-9	Dinette Table & Chairs	8-20
Chassis (Starting) Battery	6-9	Sleeping Facilities	
House Batteries	6-9	Couch-Bed Conversion	8-22
Battery Storage and Maintenance	6-9	Banquette	8-22
Trailer Wiring Connector	6-11	Sleeper Sofa	8-22
SECTION 7: PLUMBING SYSTEMS		Fresh Water Toilet	8-22
Fresh Water System	7-1	Power Roof Vents	8-23
Filling Water Tank	7-1	Slider Windows	8-23
Fresh Water Tank Capacity	7-1	SECTION 9: CARE AND MAINTENANCE	
Water Pump	7-2	Roof	9-1
Water Pump Switch	7-2	Underbody	9-1
Accumulator Tank	7-3	Exterior	9-1
Disinfecting Water Tank	7-3	Stripes and Decals, care of	9-1
External (City Water) Connector	7-4	Compartment Doors	9-2

Interior Maintenance	
Upholstery, Carpet and Draperies	9-2
Cabinets	9-3
Tables and Countertops.....	9-3
Vinyl Wallboard	9-4
Stainless Steel Sink	9-4
Bathroom	9-4
Doors and Windows.....	9-4
Vehicle Maintenance	
Chassis Service and Maintenance.....	9-4
Engine Access.....	9-5
Diesel Fuel/Water Separator	9-5
Engine Cooling System	9-5
Tires	9-6
Suspension Alignment and Tire Balance.....	9-6
Windshield Washers and Wipers.....	9-7
Lights	9-7
Automotive 12-Volt Circuit Breakers ...	9-7

SECTION 10: STORING YOUR MOTOR HOME

Preparing Vehicle for Storage	10-1
Cold Weather Storage (Winterizing).....	10-1 to 10-4
RV Antifreeze Winterization Systems	10-4
Removal from Storage	10-5

**2002 NEW VEHICLE LIMITED WARRANTY
WINNEBAGO INDUSTRIES, INC.**



WARRANTY COVERAGE TO OWNER

Winnebago Industries, Inc. of Forest City, Iowa warrants each new Winnebago and Itasca motor home to the owner for use in the U.S. and Canada as follows:

WARRANTY PERIOD

The Warranty Period for all coverages begins on the date the vehicle is delivered to the first retail purchaser or first placed in service as a demonstrator or company vehicle.

BASIC COVERAGE

The basic Warranty Period is 12 months or 15,000 miles (24,135 kilometers), on the odometer, whichever occurs first. Winnebago does not authorize any person to create for it any other obligations or liability in connection with this vehicle. ANY IMPLIED WARRANTY OF MERCHANTABILITY OR FITNESS FOR A PARTICULAR PURPOSE APPLICABLE TO THIS VEHICLE IS LIMITED IN DURATION TO THE DURATION OF THIS WRITTEN WARRANTY AS HEREINBEFORE OR HEREINAFTER PROVIDED. THE PERFORMANCE OF REPAIRS IS THE EXCLUSIVE REMEDY UNDER THIS WRITTEN WARRANTY OR ANY IMPLIED WARRANTY. WINNEBAGO SHALL NOT BE LIABLE FOR INCIDENTAL OR CONSEQUENTIAL DAMAGES FOR LOSS OF TIME, INCONVENIENCE, OR OTHER CONSEQUENTIAL DAMAGE INCLUDING EXPENSE FOR GASOLINE, TELEPHONE, TRAVEL, LODGING, LOSS OR DAMAGE TO PERSONAL PROPERTY, OR LOSS OF REVENUE RESULTING FROM BREACH OF THIS WRITTEN WARRANTY OR ANY IMPLIED WARRANTY. Some states do not allow limitations on how long an implied warranty will last or the exclusion or limitation of incidental or consequential damages, so the above limitations or exclusions may not apply to you.

ITEMS NOT SUBJECT TO WARRANTY COVERAGE.

- Chassis*
- Wheels*
- Tires*
- Service Items, such as Windshield Wiper Blades, Lubricants, Fluids & Filters
- Adjustments

*These items are covered under the manufacturer's individual warranty.

This warranty gives you specific legal rights and you may also have other rights which vary from state to state.

Also, this warranty shall not apply to failures, damage or malfunctions resulting from normal wear, misuse, abuse, negligence, alteration, accident, fire, improper repair of the vehicle or failure to follow recommended maintenance requirements.

36 MONTHS/36,000 MILE STRUCTURAL WARRANTY

At the expiration of the Basic Coverage and for the remainder of the period of 36 months or 36,000 miles (57,924 kilometers), on the odometer, whichever occurs first, Winnebago warrants the following:

1. Body Thermo-Panel® Lamination of the sidewalls and backwall against delamination. Body Thermo-Panel® Lamination is the bonding of the exterior skin and the interior paneling to an insulating core material. Delamination (separation of layers) caused by other factors such as physical damage or failure to properly maintain sealants is not covered by this warranty.
2. The slide-out room assembly for defects in material or workmanship.
3. Structural defects of the subfloor and floor. Floor lamination failure and lamination failure of the subfloor panels and risers are covered by the structural warranty.

Winnebago Industries, Inc.
P.O. Box 152
Forest City, Iowa 50436

ATTENTION: WARRANTY DEPT.

WINNEBAGO'S RESPONSIBILITY

Any part of the vehicle subject to warranty which is found to be defective in material or workmanship, will be repaired or replaced at Winnebago Industries' option upon notice of the defect without charge to the customer for parts or labor. While any Winnebago or Itasca motor home dealer can perform warranty service, we recommend you return to the dealership that sold you your vehicle. If you are touring or have moved, contact any Winnebago or Itasca motor home dealer in the United States or Canada for warranty service.

CUSTOMER RESPONSIBILITY WHEN REPAIRS ARE NEEDED

If a part of the system covered by this warranty fails to function or requires service during the warranty period:

1. Promptly take the vehicle to the selling dealer for repair or inspection.
2. Written notice of defects must be given to the selling dealer or manufacturer no later than 10 days after the expiration of the warranty.
3. If the dealer is incapable of making the repairs, request that he contact Winnebago Industries, Inc.
4. If, after the above steps are completed and the repair is not made, the customer should contact Winnebago Industries, Inc., P.O. Box 152, Forest City, Iowa 50436, Attention: Owner Relations Department (800-537-1885) and furnish the following information:
 - The complete serial number of the vehicle
 - Date of retail purchase
 - Selling dealer's name
 - Nature of the service problem, and a brief explanation of the steps or service the dealer has performed, and the results obtained. The customer may be directed to another dealer or service center for repairs to be completed, if such a dealer or service center is better able to complete the repair.

Winnebago may, at its option, request the vehicle be returned to Forest City, Iowa for repair. If the customer refuses to allow repairs to be performed at the Forest City, Iowa facility, the warranty on that repair will be voided.

5. If after the above steps are completed and the repairs are not satisfactory, the customer may contact the Service Administration Manager of Winnebago Industries, and request a customer relations board meeting to resolve the problem. This action, however, is not mandatory.
6. Certain components are covered beyond the 12 months/15,000 miles basic warranty coverage by the individual manufacturer's warranty. Please refer to the component's information supplied in the owner's information InfoCase for any additional warranty coverage after the basic warranty has expired.

PART NO. 701677-J5-000 4-01

DEALER'S REPRESENTATIONS EXCLUDED

Winnebago Industries, Inc. does not undertake the responsibility to any purchaser of its products for any undertaking, representation, or warranty made by dealers selling its product beyond those herein expressed.

INSTALLATION NOT COVERED

Winnebago Industries, Inc. cannot, however, and does not accept any responsibility in connection with any of its motor homes for additional equipment or accessories installed at any dealership or other place of business, or by any other party other than Winnebago Industries, Inc. Such installation of equipment or accessories by any other party will not be covered by the terms of this warranty.

CARE AND MAINTENANCE

It is the owner's responsibility to perform the care, maintenance and proper load distribution described in the owner's manual which accompanies your motor home. Any damage which results to your vehicle as a result of your failure to perform such duties, is not covered.

Damage to appearance items such as fiberglass, metal, paint, fabrics and trim, may occur during manufacturing or transporting. Normally, any factory defect or damage is corrected at the factory. In addition, dealers are obligated to inspect each vehicle upon delivery to them and prior to delivery to you. You should also immediately inspect appearance items and advise your selling dealer of any discrepancies. Damage and normal deterioration due to use and exposure is not covered by this warranty.

CHANGES IN DESIGN

Winnebago Industries, Inc. reserves the right to make changes in design and changes or improvements upon its products without imposing any obligation upon itself to install the same upon its products theretofore manufactured.

NEW YORK:

If your motor home has been repaired three or more times for the same nonconformity, defect, or condition, or if your motor home has been out of service by reason of repair for twenty-one days, Section 198-a of the General Business Law of the State of New York requires you to provide written notice by certified mail, return receipt requested, to Winnebago or its authorized dealer before making any claim under that section of the law. If you do have problems with your motor home, you should provide written notice to Winnebago at the following address:

Winnebago Industries, Inc.
P.O. Box 152
Forest City, Iowa 50436
Atten: Owner Relations

IMPORTANT: THIS NOTICE IS TO BE USED ONLY FOR RECORD KEEPING BY WINNEBAGO INDUSTRIES
The completed form does not constitute an actual change of ownership.

-----CUT HERE-----

NOTICE OF SECOND OWNER

ORIGINAL OWNER	NAME	
	ADDRESS	
NEW OWNER	NAME	
	ADDRESS	ZIP CODE
WINNEBAGO IDENTIFICATION NUMBER	VEHICLE MILEAGE	DATE
CHASSIS IDENTIFICATION	NEW OWNER SIGNATURE	



Congratulations on the purchase of your new Horizon motor home, which has been carefully designed, engineered and quality built by Winnebago Industries, Inc.



ABOUT THIS MANUAL

Please read this operator's manual completely to understand how everything in your coach works before taking it on its "maiden voyage."

This manual is a guide to safe operation of the features, equipment and controls in this coach. Some equipment, such as the vehicle chassis and certain electronic systems or appliances, have their own comprehensive, manufacturer supplied manuals or information sheets which describe operation of these products in great detail. This manual will refer you to the manufacturer's information included in your Owner *INFOCASE* whenever necessary.

SUBJECT ICONS - To make it easy for you to find information you're looking for, we have placed convenient, pictorial symbols called "icons" beside many of the subject headings in this manual. The icons correspond to the subject matter of the section. These icons were designed similar to the familiar international symbols which identify public facilities such as restrooms and handicap access. There are several examples of icons on this page.

PAGE ICONS - The icons at the upper corners of each page correspond to the primary content of each main section of the manual, such as LP Gas, Electrical, Plumbing, etc. This means you can flip through the manual either forward or backward and know exactly which main section you are looking for just by watching the icons at the top of the page. This means less paging back and forth.

We also urge you to read the complete Chassis Operating Guide provided by the chassis maker and all other operating information provided by our equipment suppliers and manufacturers. This is contained in your Owner *INFOCASE*.

This manual should be kept in the vehicle at all times for personal reference. The operator's manual, *INFOCASE* and chassis operating guide are to be considered permanent components of this vehicle. They should remain in the vehicle when sold to provide the next owner with important safety, operating and maintenance information.

NOTE: The descriptions, illustrations, and specifications in this manual were correct at the time of printing. We reserve the right to change specifications or design without notice, and without incurring obligation to install the same on products previously manufactured.



FREIGHTLINER CHASSIS OPERATING GUIDE

Throughout this manual, frequent reference is made to the vehicle chassis operating guide. The chassis guide is the operator's manual provided by Freightliner, the manufacturer of the chassis on which this motor home is built. Consult the chassis guide for operating safety and maintenance instructions pertaining to the chassis section of the motor home.

DIESEL ENGINE MANUAL

Consult your Caterpillar or Cummins Diesel Engine Operation and Maintenance Manual for information on all engine related topics such as engine maintenance, fluid level checks, capacities, and service parts, etc.



INTRODUCTION



OWNER'S INFOCASE

Your InfoCase contains information supplied by manufacturers of individual appliances and equipment installed in your motor home.

Consult this information regarding the operation and care of appliances, accessories and special equipment.

OPTIONS AND EQUIPMENT

Some equipment described in this manual may not apply to your coach.



BEFORE DRIVING

Before sitting in the driver's seat, always check around your vehicle to be sure you have proper clearance for maneuvering. If necessary, have a passenger help guide you out of a difficult parking space.

Although your coach features automotive conveniences like power steering and power brakes, driving a motor home is different from driving a car. A motor home is larger and heavier than an automobile, so it requires more stopping and passing distance, and more parking and maneuvering space than a car does.

Always be aware of the size of your motor home. The added height of TV antennas or luggage boxes may cause clearance problems around some tunnels, canopies and hanging signs. Know the height of your coach so you can observe posted clearance limits. Also, remember that some bridges, old ones in particular, may not support the weight of your motor home. Know the weight of your unit and observe any posted weight limits.

Remember: Always use your seat belt and be sure your passengers do so as well. We also advise making frequent rest stops while traveling to relieve stress on yourself, your passengers and your vehicle.

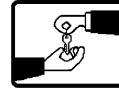

SERVICE AND ASSISTANCE

Your Winnebago Industries dealer will be glad to provide any additional information you need, as well as answer any questions you might have about operating the equipment in your motor home. When it comes to service, remember that your dealer knows your vehicle best and is interested in your satisfaction. Your dealer will provide quality maintenance and any other assistance that you may require during your ownership of this vehicle.

If you need warranty repairs while traveling, however, you may take your motor home to any Winnebago or Itasca dealership and they will assist you.



WARRANTY

Your new Horizon is covered by a factory warranty against defects in material and workmanship. This warranty should be validated immediately and returned to the factory by your dealer. For additional information, see your "New Vehicle Limited Warranty" included with this vehicle.



DRINKING AND DRIVING

Winnebago Industries supports the recommendations of the Presidential Commission on Drunk Driving.

- Exercise your good judgment and encourage others to do the same.
- Know the legal limits and do not exceed them.
- Also know your personal limits, which may be lower than the legal limits.
- Should you ever exceed your limits, find alternative transportation; call a cab, ask a friend to drive you home or call a family member to come and get you.



The presence of alcohol in significant levels in the blood increases the probability that the driver will be involved in an accident.

REPORTING SAFETY DEFECTS

If you believe that your vehicle has a defect which could cause a crash or could cause injury or death, you should immediately inform the National Highway Traffic Safety Administration (NHTSA) in addition to notifying Winnebago Industries, Inc.

If NHTSA receives similar complaints, it may open an investigation, and if it finds that a safety defect exists in a group of vehicles, it may order a recall and remedy campaign. However, NHTSA cannot become involved in individual problems between you, your dealer, or Winnebago Industries.

To contact NHTSA, you may either call the Auto Safety Hotline toll-free at 1-800-424-9393 (or 366-0123 in Washington, D.C. area) or write to: NHTSA, U.S. Department of Transportation, Washington, D.C. 20590. You can also obtain other information about motor vehicle safety from the Hotline.



VEHICLE CERTIFICATION LABEL

This label contains vehicle identification and other important reference information. The vehicle certification label is located on the sidewall to

the left of the steering wheel, or on the driver's door. Never remove or destroy this label.

MANUFACTURED BY



INCOMPLETE VEHICLE MANUFACTURED BY ① MOTOR CORP.

MONTH AND YEAR OF MANUFACTURE: ②

GVWR ④ LB _____ KG

SUITABLE TIRE AND RIM CHOICE COLD INFLATION PRESSURE

TIRE RIM PSI KPA SINGLE

FRT LB _____ KG ⑥ ⑦ ⑧ PSI _____ KPA ⑨

RR. ⑤ LB _____ KG

THIS VEHICLE CONFORMS TO ALL APPLICABLE FEDERAL MOTOR VEHICLE SAFETY STANDARDS IN EFFECT ON THE DATE OF MANUFACTURE SHOWN ABOVE.

SERIAL NO. ⑩ VIN ⑪

TYPE ⑫ MODEL ⑬ COLOR ⑭

EXPLANATION OF DATA

1. Chassis manufacturer.
2. Chassis manufacture date.
3. Month and year of manufacture at Winnebago Industries.
4. Gross Vehicle Weight Rating: Total permissible weight of the vehicle, including driver, passengers, total cargo carried (including all liquids) and equipped with all options.
5. Gross Axle Weight Rating: Total permissible weight allowed for the front and rear axles (listed in pounds and kilograms).
6. Suitable Tire Choice: Tires recommended to meet handling and safety requirements. When replacing any of the tires on your vehicle, always replace with a tire that meets these specifications.
7. Suitable Rim Choice: Wheel rims recommended to meet handling and safety requirements. When replacing any of the rims on your vehicle, always replace with a rim that meets these specifications.
8. Cold Inflation Pressure: Inflation pressures recommended (while Cold) for the tires originally equipped on your vehicle. These pressure levels must be maintained to assure proper handling, safety and fuel economy.
9. Rear Axle Wheel Configuration: Single or Dual.
10. Serial Number: This is the serial number assigned to the completed vehicle by Win-

- nebago Industries. The 10th digit of the VIN designates the chassis model year. (Y=2000, 1=2001, 2=2002) This information is useful when ordering chassis repair parts.
11. Vehicle Identification Number (VIN): This number identifies the chassis on which the motor home is built.
12. Type: States the NHTSA designated usage classification for your motor home. MPV signifies a Multi-purpose Passenger Vehicle.
13. Model: Lists the Winnebago product model number of your vehicle.
14. Color: Signifies the color code number of the decor used throughout the vehicle. This number is necessary for ordering replacement cushions, curtains, carpet, etc.

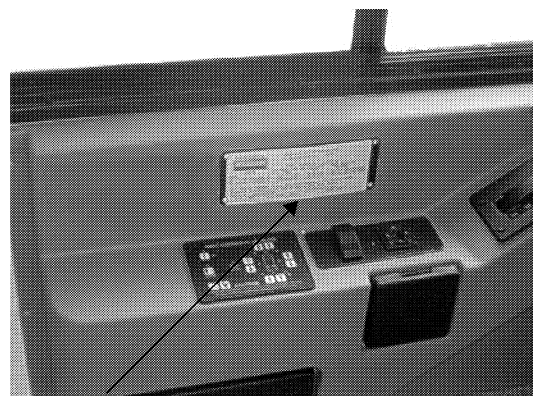

Vehicle Certification Label



EXTERIOR FEATURE IDENTIFICATION

Composite model shown for illustration purposes only.
Actual locations of features depends on coach model and options.



Storage
Compartments

Holding Tank
Dump Valves

Water Center/
Shoreline
Compartment††

Engine Fluid
Check Access*



Batteries

!Water Heater
Service Access

!Furnace Intake/
Exhaust Port

LP Gas
Tank

Storage
Compartments**

Exterior
Entertainment
Center (Opt.)

NOTE: Some equipment shown may be optional.

*Also contains diesel fuel filter/water separator.

**Also contains optional freezer unit if equipped.

††Also contains Cable TV and Phone hookups and engine block heater plug-in.

!Be Careful! Exhaust outlet surface may become **HOT** while using furnace or water heater.



Read and understand all instructions and precautions in this manual before operating your new motor home. Throughout this manual, certain items are labeled NOTE, CAUTION and WARNING. These terms alert you to precautions that can involve risk to your vehicle or to your personal safety. Read and follow them carefully.

NOTE: Indicate special points of information.

CAUTION

Indicates that a failure to observe can cause damage to vehicle or equipment

WARNING

This symbol is used to alert you to precautions that involve your personal safety as well as vehicle damage. Read and follow them carefully.

Listed below are some safety precautions that must be adhered to. These precautions as well as others that involve damage to equipment are also listed in the appropriate areas in this manual.



GENERAL WARNINGS

- Only seats equipped with seat belts are to be occupied while the vehicle is moving.
- All seats which can be positioned, such as swiveling, sliding, reclining, or footrest out, must be placed in a fully upright and swivel-locked position with footrests retracted while the vehicle is moving. Some swivel lounge chairs are designed to lock in a forward facing position, while others lock in an aisle facing position. Be certain these seats are secure from swiveling before traveling.

- Make sure all passengers have seat belts fastened in a low and snug position so the force exerted by the belt in a collision will be spread across the strong hip area. Pregnant women should wear a lap-shoulder belt whenever possible, with the lap belt portion worn low and snug throughout the pregnancy.
- Before driving, secure dinette chairs with retainer strap provided as shown in Section 8.
- Never let passengers stand or kneel on seats while the vehicle is moving.
- Sleeping facilities are not to be utilized while vehicle is moving.
- Examine the escape window and be familiar with its operation, but do not use except in an emergency.
- Inspect the fire extinguisher monthly for proper charge and operating condition. This should also be done before beginning a vacation or any extended trip.



DRIVING

- Do not attempt to adjust the driver's seat while the vehicle is moving.
- Do not adjust tilt steering in a moving vehicle.
- Do not operate the cruise control on icy or extremely wet roads, winding roads, in heavy traffic, or in any other traffic situation where a constant speed cannot be maintained.
- Use care when accelerating or decelerating on a slippery surface. Abrupt speed changes can cause skidding and loss of control.



SECTION 1
SAFETY PRECAUTIONS

Horizon

- Driving through water deep enough to wet the brakes may affect stopping distance or cause the vehicle to pull to one side. Check brake operation in a safe area to be sure they have not been affected. Never operate any vehicle if a difference in braking efficiency is noticeable.
- Adverse weather conditions and extremes in terrain may affect handling and/or performance of your vehicle. Refer to your chassis manual for related information.



FUEL & LP GAS



- All pilot lights must be extinguished and appliances turned off while refilling the fuel tank or LP tank.
- Never smoke while refilling vehicle fuel tank or LP gas tank.
- Avoid inhaling exhaust gases produced by burned gasoline, diesel fuel or LP gas in items such as the range, chassis engine, generator engine, refrigerator, furnace and water heater. They contain carbon monoxide, which is an odorless, colorless and poisonous gas.
- Do not bring or store LP gas containers, gasoline or other flammable liquids inside the vehicle because a fire or explosion may result. LP gas containers are equipped with safety valves which relieve excessive pressure by discharging gas to the atmosphere.
- Do not alter the LP gas system at any time or in any way.
- Do not fill LP gas container(s) above 80 percent of capacity. Overfilling the LP gas container can result in uncontrolled gas flow which can cause fire or explosion. A properly filled container will contain approximately 80 percent of its volume as liquid LP gas.
- Never use an open flame to test for LP gas leaks. Replace all protective covers and caps on LP system after filling. Make sure valve is closed and door latched securely.
- Never connect natural gas to the LP gas system.
- When lighting range burners do not turn burner controls to "On" and allow gas to escape before lighting match.
- Portable fuel-burning equipment, including wood and charcoal grills and stoves, shall not be used inside the recreational vehicle. The use of this equipment inside the recreational vehicle may cause fires or asphyxiation.
- LP gas regulators must always be installed with the diaphragm vent facing downward. Regulators are equipped with a protective cover. Make sure that the regulator vent faces downward and that the cover is kept in place to minimize vent blockage which could result in excessive gas pressure causing fire or explosion.
- The following warning label is located in the cooking area to remind you to provide an adequate supply of fresh air for combustion.

WARNING

IT IS NOT SAFE TO USE COOKING APPLIANCES FOR COMFORT HEATING

COOKING APPLIANCES NEED FRESH AIR FOR SAFE OPERATION. BEFORE OPERATION:

1. OPEN OVERHEAD VENT OR TURN ON EXHAUST FAN AND;
2. OPEN WINDOW.

Unlike large homes, the oxygen supply inside a recreational vehicle is limited due to its size. To avoid danger of asphyxiation, provide proper ventilation when using the gas rangetop or gas oven. It is especially important that the gas oven and range top not be used for comfort heating. Danger of asphyxiation is greater when these appliances are used for long periods of time.



LP GAS LEAKS

The following label is located in the vehicle near the range area. If you smell gas within the vehicle, quickly and carefully perform the procedures listed.

IF YOU SMELL GAS

1. Extinguish any open flames, pilot lights and all smoking materials.
2. Do not touch electrical switches.
3. Shut off the gas supply at the tank valve(s) or gas supply connection.
4. Open doors and other ventilating openings.
5. Leave the area until odor clears.
6. Have the gas system checked and leakage source corrected before using again.



LP GAS ALARM

Your coach is equipped with an LP gas detector which sounds an alarm if an unsafe amount of LP gas is present inside the coach. Because LP gas is heavier than air, the detector is located on a cabinet face near the floor of the coach.

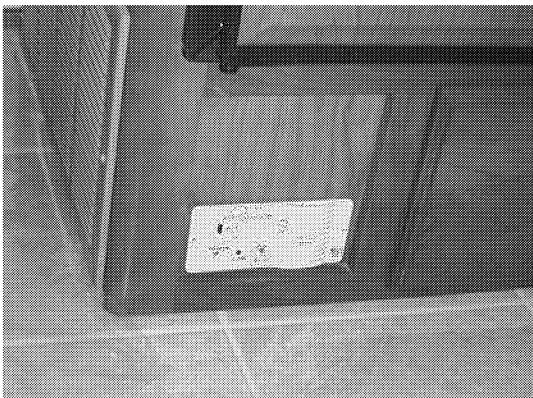

A green light on the face of the alarm shows when the unit is active. The red button is used to reset the alarm.

Press to stop alarm

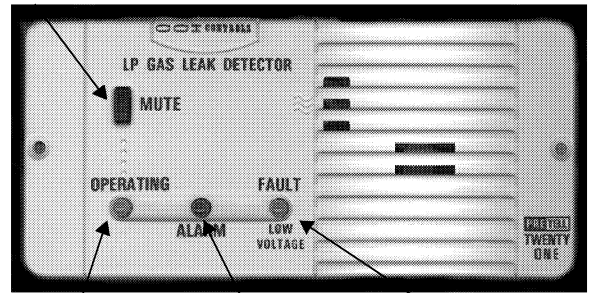

Green
(Active)

Red
(Alarm)

Amber
(Low Batt.)

If The Alarm Sounds

If the alarm sounds, do not touch any electrical switches. Immediately turn off the main LP tank valve and all LP appliances, open all windows and roof vents, and leave the coach until the alarm stops sounding.

If the alarm keeps sounding at regular intervals, a leak may be present. Contact your dealer or an LP gas service center to have the problem corrected before using the LP system again.

If the coach batteries become extremely drained, an amber light on the face of the alarm will come on and in some cases the LP alarm may begin to sound on its own. This condition typically occurs only during storage situations when battery charge is not being restored by the inverter charger or solar charger.

WARNING

Never use an open flame to test for gas leaks. When testing for gas line leaks with a soapy water solution, DO NOT use a detergent containing ammonia or chlorine. These substances may generate a chemical reaction causing corrosion to gas lines, resulting in dangerous leak conditions.

Power Connection

The gas alarm is powered by the coach batteries. If the battery cable is disconnected from the batteries, auxiliary battery switch is shut off, or the circuit breaker is tripped, the alarm will not



SECTION 1 SAFETY PRECAUTIONS

Horizon

work. The LP gas alarm breaker is located on the coach breaker fuse panel shown on page 6-8.

Because the LP gas alarm is connected directly to the auxiliary battery, it is always drawing a small amount of current. Even though this current draw is slight, it could drain the coach battery during storage periods of 30 days or longer. We recommend turning the auxiliary battery switch off or disconnecting the battery cables from the auxiliary battery during extended storage periods to avoid discharge.

Further Information

See the manufacturer's information entitled "Your LP Gas Detector" in the Owners InfoCase for further instructions on nuisance alarms and care and testing of the LP gas detector.



ELECTRICAL

- Careless handling of electrical components can be fatal. Never touch or use electrical components or appliances while feet are bare, while hands are wet, or while standing in water or on wet ground.
- Improper grounding of the vehicle can cause personal injury. Do not plug the utility power cord into an outlet which is not grounded and do not adapt the plug to connect to a receptacle for which it is not designed.
- Do not attach an extension cord to the utility power cord.
- Be sure that all electrical appliances to be used contain 3-prong plugs for proper grounding.
- Avoid overloading electrical circuits. Replace fuses or circuit breakers with those of the same size and amperage rating only. Never use a higher rated fuse or breaker.
- Use caution when handling or working near electrical storage batteries. Always remove jewelry and wear protective clothing and eye covering. Avoid creating sparks.

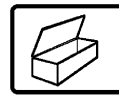

LOADING

- Store or secure all loose items inside the motor home before traveling. Possible overlooked items such as canned goods or small appliances on the countertop, cooking pans on the range, or free-standing furniture items can become dangerous projectiles during a sudden stop.
- Be aware of GVWR, GAWR and individual load limit on each tire or set of duals. (See "Loading the Vehicle" in Section 4.)
- Never load the motor home in excess of the gross vehicle weight rating or the gross axle weight rating for either axle.

NOTE: *Your motor home's load capacity is designated by weight, not by volume, so you cannot necessarily use all available space when loading your motor home.*



MAINTENANCE

- Do not remove the radiator cap while engine and radiator are still hot. Always check coolant level visually at the see-through coolant reservoir.
- Never get beneath a vehicle that is held up by a jack.
- Do not mix different construction types of tires on the vehicle such as radial, bias or belted tires, as vehicle handling may be affected. Replace tires with exact size, type and load range.
- Do not attempt to start the vehicle by hot wiring.



FORMALDEHYDE INFORMATION

WARNING

Some components in this vehicle contain formaldehyde based adhesives which may release formaldehyde fumes into the air for an unknown period of time until total dissipation occurs. Individuals who are allergic to formaldehyde gas fumes may experience irritation to eyes, ears, nose and throat. Reaction in infants may be more severe. Although long range effects are not well understood, testing to date has not revealed any serious health effects in humans at the level of emission from these products.

IMPORTANT

To aid in dissipation, ventilate the vehicle by opening all windows and circulating the air with a fan.

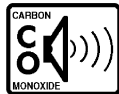

CARBON MONOXIDE WARNING

WARNING

Avoid inhaling exhaust gases, as they contain carbon monoxide, which is a colorless, odorless and poisonous gas.

If you suspect that exhaust fumes are entering the passenger compartment, have the cause determined and corrected as soon as possible. If you must drive under these conditions, drive only with **ALL WINDOWS FULLY OPENED**.

The best protection against carbon monoxide entry into the vehicle body is a properly maintained engine exhaust and ventilation system. It is recommended that the exhaust system and body be inspected by a qualified motor home service center.

- Each time the vehicle is raised for an oil change.
- Whenever a change in the sound of the exhaust system is noticed.
- Whenever the exhaust system, underbody or rear of the vehicle is damaged.

To allow proper operation of the vehicle's ventilation system, keep front ventilation inlet grill clear of snow, leaves or other obstructions at all times. **DO NOT OCCUPY A PARKED VEHICLE WITH ENGINE RUNNING FOR AN EXTENDED PERIOD.**

Do not run engine in confined areas, such as a garage, except to move vehicle in or out of area. When vehicle is stopped in an **UNCONFINED** area with the engine running for any more than a short period, adjust heating or cooling system to force outside air into the vehicle as follows:

1. Set fan to medium or high speed and vent control to air.
2. On vehicles equipped with air conditioning, set fan to medium or high speed and set control to obtain maximum vent air.

Rear windows should be closed while driving to avoid drawing dangerous exhaust gases into the vehicle.

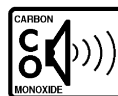

CARBON MONOXIDE ALARM

Your coach is equipped with a carbon monoxide (CO) alarm, located on the ceiling in the bedroom area.

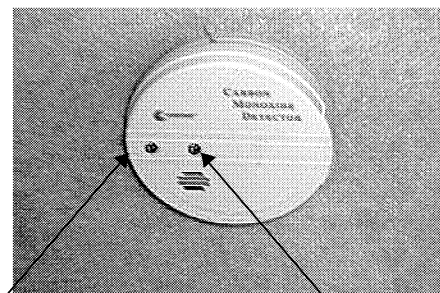

Red Light
(Press to Test Alarm)

Yellow Light
(Warning)



SECTION 1 SAFETY PRECAUTIONS

Horizon

The CO alarm is powered by a 9-volt battery and contains a sensor that is designed to detect toxic carbon monoxide gas fumes resulting from incomplete combustion of fuel. It will detect CO gas from any combustion source such as the furnace, gas range/oven, water heater, refrigerator, chassis engine, and electric generator engine.

- Patented biomimetic sensor mimics the human response to Carbon Monoxide.
- Test/Reset provides for one time alarm silence and multiple warning silence. Also tests alarm circuitry, microprocessor, battery and horn.
- Red light flashes once every thirty seconds in normal operation.
- Continuous yellow light with a beep every three seconds indicates an unhealthy CO level.
- Continuous red light and pulsating alarm signal a dangerous CO condition.
- Battery operation provides protection 100% of the time. Low battery signal alerts consumer of need to replace battery.
- 85 decibel alarm assures waking during sleeping hours.

Monthly Testing

Press the TEST button on the face of the alarm periodically (at least monthly) to check the function of the alarm and condition of the battery. If the alarm begins to beep every few seconds, the battery may be weak and need replacement. (Press the TEST button to be sure before replacing the battery. If the alarm sounds, the battery may still be okay. If the alarm still beeps every few seconds, check the smoke detector also. The “low battery” warning beep is similar on many alarm devices, so the origin of this electronic sound can be deceiving.)

Further Information

Please read the information provided by the manufacturer, which is included in your Owner’s InfoCase. It includes information on precautions, operational testing, and battery/sensor replacement.



EMERGENCY EXITS Emergency Exit Windows

Your motor home is equipped with an emergency exit window in the bedroom which functions as an escape exit in an emergency situation.

WARNING

Use emergency window for emergency exit only. Do not test for proper operation.

Use care when exiting emergency window, as broken glass may be present in the exit area.

The side mounted escape window is secured by two safety latches and can be opened by first releasing these two latches and then pushing outward on the lower part of the window. Identify which type of emergency exit window is in your vehicle.

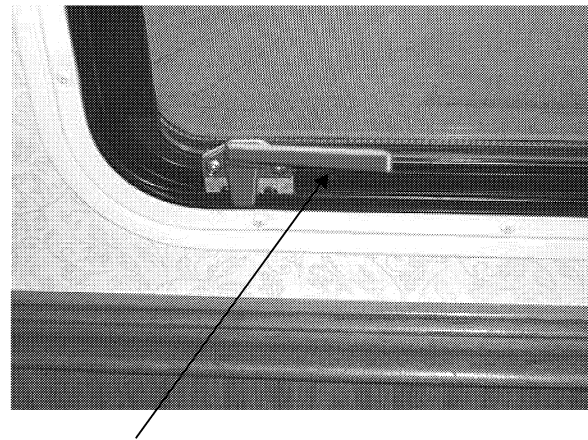

Lift Both Handles Up
Push Out on Bottom of Window

Instructions for removal are also located on a label on the glass for quick reference and for passengers who may not be familiar with the exit. Never remove or destroy this label.

Using Slider Windows as Emergency Exits

Slider windows along the side of the motor home can also be used as emergency exits, should the need arise. To use the windows as



exits, slide the window open, then slide the screen open.

SAFETY DEVICES



FIRE EXTINGUISHER

A dry chemical fire extinguisher is located near the floor by the passenger side front door.



We recommend that you become thoroughly familiar with the operating instructions displayed on the side of the fire extinguisher or in the information supplied in your Owner's InfoCase.

We also recommend that you inspect the fire extinguisher for proper charge at least once a month in accordance with National Fire Protection Association (NFPA) recommendations as stated on the label. If the charge is insufficient, the fire extinguisher must be replaced.

WARNING

Do not test the fire extinguisher by discharging it. Partial discharge can cause leakage of pressure or contents which would render the unit inoperative when needed. When using the fire extinguisher, aim the spray at the base of the fire.



SMOKE ALARM

Your motor home is equipped with a smoke alarm located on the ceiling in the galley and lounge area. This alarm meets U.L. Standard 217 and NFPA Standard 74 for operation of smoke detection devices.



1. The smoke alarm should be tested for correct operation each time the vehicle is brought out of storage, before each trip, and at least once a week during motor home use. To test the electronics, firmly depress the button. To test that smoke reaches the sensor, blow smoke in a careful, fire-safe manner into your smoke alarm.

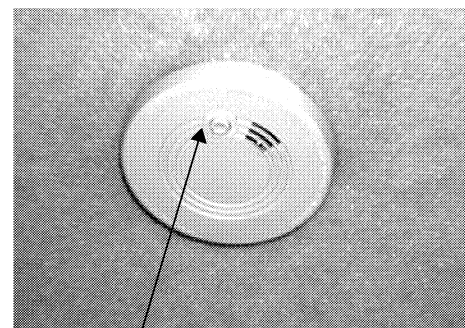

Press to Test

2. Your smoke alarm will not work without power. Never remove the battery to quiet the alarm. When your smoke alarm "beeps" about once a minute the battery is weak.



SECTION 1 SAFETY PRECAUTIONS

Horizon

Install a new battery immediately. Be sure to use only batteries specified in manual or on unit. Test unit after installing a new battery.

3. Clean and vacuum the openings on your smoke alarm once a month. Do not open the smoke alarm or try to repair it. For replacement information see warranty in Owner's Manual.
4. Smoke alarms have technical limitations and may not respond in all situations. FIRE PREVENTION is your best safeguard.

See your Owner's InfoCase for further information.

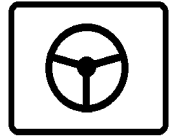

(See also Safety Precautions, Section 1 of this manual.)

NOTE: See your Freightliner chassis operator's manual for information on starting the engine, operating the transmission, steering column controls, descriptions of instrument gauges, and other chassis related information.

Some items described in this section may be optional or unavailable on your coach.



BEFORE ENTERING YOUR VEHICLE

Before entering your vehicle, there are a few recommended procedures that will aid in your driving safety and equipment.

1. Be sure that the windows, mirrors and light lenses are clean and unobstructed.
2. Make sure all exterior lights operate properly.
3. Check tires for proper cold inflation pressures and inspect for any unusual wear.
4. Check wheel lug nuts for tightness.
5. Look beneath the vehicle for noticeable fluid leakage.
6. Check fluid levels and fill if necessary. This includes engine oil, transmission fluid, coolant, brake fluid, power steering fluid and windshield washer solvent.

WARNING

The engine should be shut off unless specifically required for a certain procedure.

The transmission must be in N (Neutral) and park brake applied while performing any checks or adjustments.

7. Unhook and store sewer and water supply hoses.
8. Disconnect and store shoreline.
9. Retract step.
10. Be sure that all of your cargo is secured in event of a sudden stop or an accident.
11. Check around your vehicle in all directions to assure that you have proper clearance.
12. Lower TV antenna.

WARNING

Before driving your vehicle, be sure you have read the entire operator's manual and that you understand your vehicle's equipment completely and how to use the equipment safely.



BEFORE DRIVING YOUR VEHICLE

Before preparing to drive your vehicle, here are a few recommended procedures that will add to your driving safety and enjoyment.

1. Be sure that you adjust the interior and exterior rear view mirrors to your driving preference.
2. Adjust the driver's seat for proper distance from foot pedals and steering wheel to allow for safety and ease in controlling your vehicle.



3. Place front seats in the forward facing position.
4. Be sure to fasten all safety belts to fit you comfortably, but tight enough to obtain the full safety of the belts.
5. Make sure all doors are completely shut and locked. When the doors are shut and locked, there is less chance of the doors flying open in event of an accident. It also prevents unintentional opening of doors and keeps intruders out of your vehicle.
6. Check to see that all gauges are operating properly.
7. Check the fuel level in the vehicle.
8. Be certain that the fire extinguisher is fully charged and secure in its mounting bracket.

CAUTION

Be sure hood and all compartment doors are latched securely before driving vehicle.

“KEY ONE” LOCK SYSTEM

Your coach is equipped with the new Key One™ lock system. A single key will open every door lock in the entire motor home (except the security deadbolt lock on the entrance door). This means you don't have to sort through a handful of keys to find the right one for the water fill door or the luggage doors or the entrance door or the driver's door.

The key number for your coach is registered in our factory database, so if you ever lose your keys, any Winnebago Industries dealership can easily order a new key for you. They are also equipped with special master keys and can unlock your coach for you if needed.



FUEL SELECTION

Refer to your Freightliner chassis operating guide for the manufacturer's recommendations on proper fuel selection.

Winter Fuel Waxing and Anti-Gel Additives

In sub-freezing temperatures, #2 diesel fuel can form small wax crystals that become trapped in the fuel filter and block the fuel flow to the engine, causing it to stall out. At sub-zero temperatures, the fuel can congeal and turn “slushy”. If this happens, the only remedy is to have the vehicle towed into a heated facility to allow the fuel to warm up and become fully liquid again.

During winter time, most truck stops and reputable filling stations have winter blend diesel fuels available that are less susceptible to waxing.

There are also commercially available products, typically called anti-gel additives, to add to diesel fuel while filling the tank to inhibit wax formation in freezing temperatures.

Consult your Freightliner chassis guide or Caterpillar engine guide for more information on fuel requirements and additives.

FILLING THE FUEL TANK

Diesel fuel, especially #2 grade, can foam up while being pumped into the tank. Sometimes this foam can cause the pump nozzle to shut off before the tank is actually full. Allow the foam to settle then resume filling at a slower flow rate until the tank is full.

Diesel Fuel Tank Capacity..... 90 gal. diesel



STARTING AND STOPPING ENGINE

Refer to your Freightliner chassis operating guide for the manufacturer's recommendations on starting and stopping the engine.

See also “Engine Block Heater” elsewhere in this section.

Cold Weather Starting: Please note the following cold weather starting precautions. These labels are also located in appropriate areas of the coach. Failure to follow these precautions could cause serious damage to your diesel engine.

WARNING
 DO NOT USE ETHER
 OR STARTING FLUID

INTAKE MANIFOLD HEATER
 MAY CAUSE EXPLOSION
 AND SEVERE INJURY.

Be sure the engine heater cord is plugged into the outlet above the inverter/charger in the shore-line compartment as shown. In warm weather you may wish to unplug this cord to avoid accidental use of the engine heater.



ENGINE BLOCK HEATER

Your coach is equipped with an engine block heater to assist starting in freezing temperatures. The power cord is located in the rear cargo compartment on the driver side of the coach. When plugged into the receptacle, the heater is connected to both the shoreline and the auxiliary generator, so a separate extension cord is not needed. The power switch is a standard household light switch in a cabinet as shown.

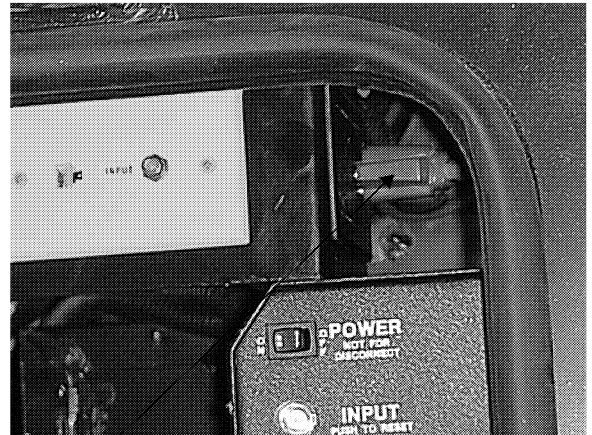

Engine Heater Cord above Inverter/Charger in Shoreline Compartment

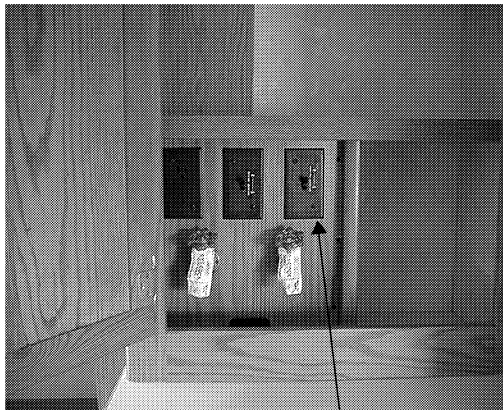

Engine Block Heater Switch
 (Typical)

REMEMBER! Turn the engine heater switch off after starting the engine. The heater will keep operating for as long as it is supplied with electricity. If the switch is left on, the engine heater will come on each time you hook up the shoreline cord or start the generator.



PARKING BRAKES

The parking brakes are applied by pulling outward on the large yellow knob on the dash to the left of the ignition switch. Push the knob in to release the brakes.

To Use the Engine Heater

With the shoreline cord plugged into a shoreline hookup, turn on the engine heater power switch.

If a shoreline hookup is not available, just start the auxiliary generator to provide power to the engine heater.

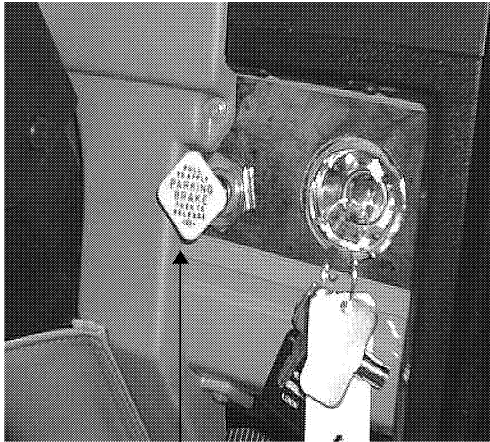

Parking Brake Knob

Use the parking brakes whenever the vehicle is parked. Never try to drive the vehicle with the park brake applied. This can cause excessive wear on the brakes and may damage the transmission.

NOTE: It is normal to hear an occasional burst of air pressure from the rear of the vehicle. This is an automatic moisture purging feature of the air brake system. See the Brakes section of your Freightliner chassis manual for instructions on periodic draining of brake air tank.

JACOBS® EXTARDER™ ENGINE EXHAUST BRAKING SYSTEM

To Use the Exhaust Brake: The exhaust brake activation switch is located on the lower left side of the dash. Press and release the ON side of the switch to activate the exhaust brake system. The exhaust brake will operate whenever you let up on the throttle pedal while the switch is ON.

Press and release the OFF side of the switch to deactivate the exhaust brake system and return to chassis brakes alone.

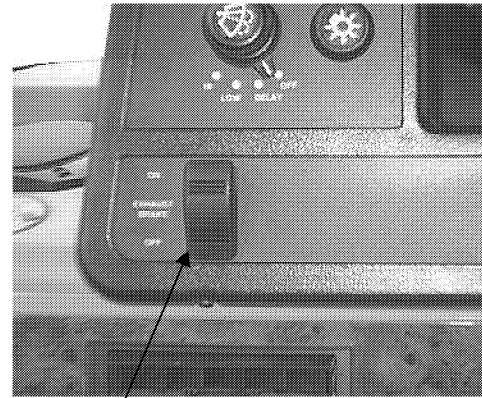

Exhaust Brake Switch

How It Works: The Jacobs® Extarder™ is an engine compression retarder that generates “braking” power by controlled restriction of the engine’s exhaust gas flow.

When the exhaust brake is activated, a valve closes off the engine’s exhaust causing the exhaust back pressure to increase, which causes the vehicle to slow down.

The increased back pressure would normally stop the engine except the forward momentum of the vehicle keeps the drivetrain and the engine turning.

This controlled back pressure helps to regulate a vehicle’s downhill speed, such as on mountainous or hilly roads. It also provides “braking” on level or near-level roads.



HAZARD WARNING LIGHTS

The hazard warning flasher switch is located on the underside of the steering column near the signal/cruise lever. Pull the switch button outward from the column to activate the flashers. To cancel flashers, push the switch button inward toward the column. See also Section 3 for further operating information.



ed security and should be used as a security night lock.

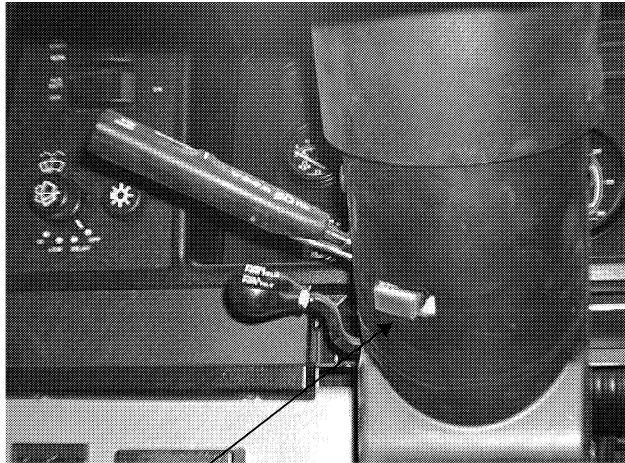

Hazard Light Switch
Pull On/Push Off

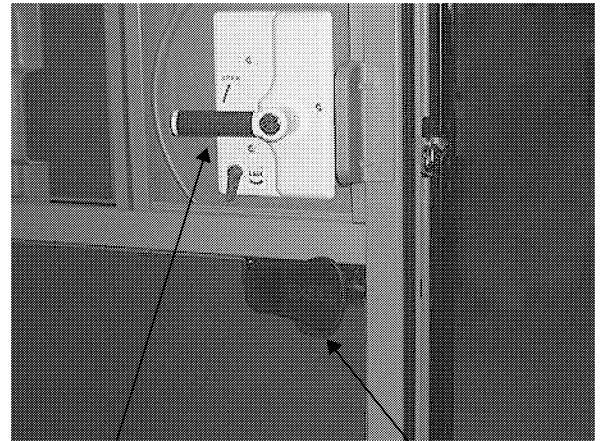

Door Latch Handle Screen Door Latch

Entrance Door Handle - Inside



ENTRANCE DOOR LOCK AND HANDLE

The entrance door may be opened from outside the vehicle by pulling the door handle outward. To open the door from inside, pull outward on the door handle. When the door is locked, neither the inside nor the outside door handle can be operated. It can be locked and unlocked from the outside of the vehicle by inserting the key into the lock and turning.

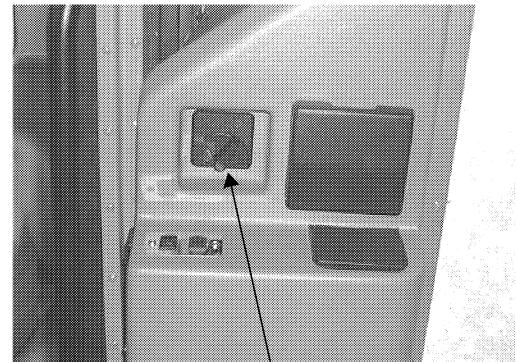

Deadbolt lock
beside passenger front seat



Entrance Door Handle - Outside

To lock the door from inside, rotate the lock levers as indicated. The deadbolt lock is for add-

Lubricate the locks periodically with graphite to maintain good working condition.

CAUTION

When releasing security night lock, be sure to retract bolt before opening door latch to prevent drag on bolt pin. Instruct all passengers in operation of this door catch system as well as emergency exit window.

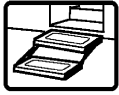

ELECTRIC ENTRANCE STEP

The power switch for the electric entrance step is located to the left of the main entry door as you enter the coach.

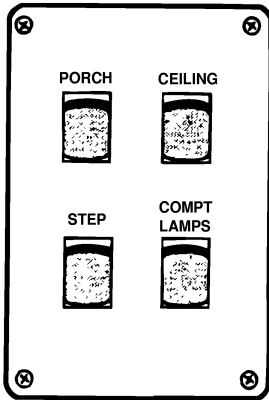

Entry Switch Panel

Automatic Mode (Operates with Door)

With the Power Switch in the On position the step is in Automatic Mode. This means it will extend and retract automatically whenever the door is opened or closed. This is done by means of a magnetic door switch attached to the lower hinged edge of the screen door section of the entrance doors. The steps will extend when the screen door is opened, and retract when the screen door is closed. With the power switch in the Off position the step can be kept in the extended or retracted position as described below.

Stationary Extended Mode

To keep the step in the extended position:

- turn the Power Switch to **On**,
- **open** the screen door to extend the step,
- then turn the Power Switch to **Off**.

The step will now stay extended whether the door is opened or closed. This position is normally used when parked at a campsite or whenever people are going to be entering and exiting the vehicle frequently.

Stationary Retracted Mode

To keep the step in the retracted position:

- turn the Power Switch to **On**,
- **close** the screen door to extend the step,
- then turn the Power Switch to **Off**.

The step will now stay retracted when the screen door is open or closed. This position is normally used where an exterior step is not required or to avoid damage to the step, such as when parked near a high curb or similar object.

Automatic Retraction Feature

The coach is equipped with a step retraction feature that retracts the step automatically when the Ignition Switch key is turned to either the On or Start position regardless of whether the Step Power Switch is On or Off. This feature is standard and is installed to prevent injury or damage which may be caused by an extended step when the vehicle is moving. An associated feature is the “Last Out Feature”. This feature extends the step when the screen door is opened after the ignition switch has been turned to either the On or Start position.

WARNING

Do not use steps unless it is fully extended.

Do Not Stand on step when vehicles ignition switch is turned to either the “On” or “Start” position. The step will automatically retract, which may cause personal injury. Always remember to retract the step before moving the vehicle.



For additional information on the step, see the step manufacturer's operators manual included in your Owners *InfoCase*.

STEPWELL COVER

The stepwell cover can be extended to cover the stepwell area and increase usable floor space in the front of the coach while the entrance door is not in use.

Press and release the Step Cover switch on the passenger sidewall armrest. The step will extend or retract fully. It is not necessary to hold the switch down while the cover is extending or retracting.

- Press once to extend.
- Press again to retract.

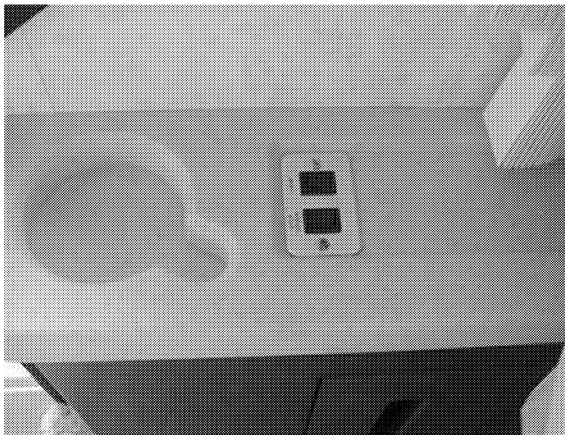

The step cover movement is powered by air pressure from the air brake/horn system. If system air pressure drops below 60 psi (shown on gauge in lower center of instrument panel), the step cover will not operate properly. If the air pressure is too low to retract step, use the Emergency Air Release Valve as described below.

Air Pressure Gauges



CAUTION

Stay clear of entrance step area when stepwell is being extended or retracted. When entering or exiting, loose clothing may catch on components of the mechanism. Personal injury and/or property damage may result.

Stepwell Cover Emergency Air Release Valve:

Rotate the knob so it points to OPEN to bypass air pressure to the step mechanism. This allows you to stop the travel of the step cover while extending, if necessary. It also allows you to manually push the step cover back into the storage position for use of the step in case of low air pressure.

Emergency Position - Open
(Normal - Closed)

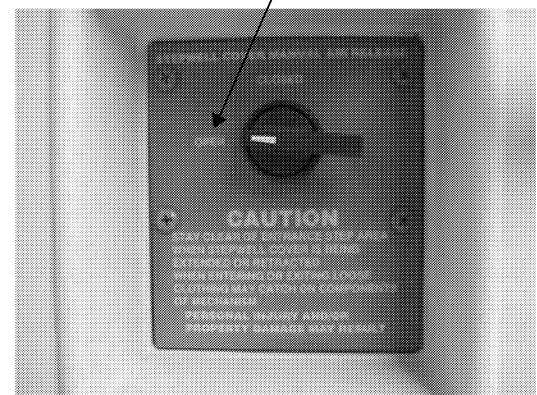

Rotate the knob pointer back to the CLOSED position to resume power operation.



LUGGAGE COMPARTMENT DOORS

To ensure that compartment doors have latched properly, press the bottom edge of the door with the palms of your hands. This is more important for smaller and lighter compartment doors because when the door is “dropped” closed, the air trapped inside the compartment may create a cushioning effect that could sometimes prevent door latches from engaging properly.



POWER ELECTRIC MIRRORS

The electric mirrors are adjusted using a multi-directional switch located on the driver’s side armrest.



Power Mirror Controls

Select the mirror to be adjusted by pushing the switch in the middle of the control to the right or left. Then press the arrow buttons as necessary to obtain the best view.

When mirrors are adjusted to preference, place the selector switch back in the middle position to cancel power to the buttons. This prevents accidental misadjustment of mirror settings.

The mirrors also contain heating elements to defog or de-ice the mirror glass during cold weather operation. An ON-OFF switch for the mirror heaters is located near the remote mirror controls.

Press to move mirror in indicated direction

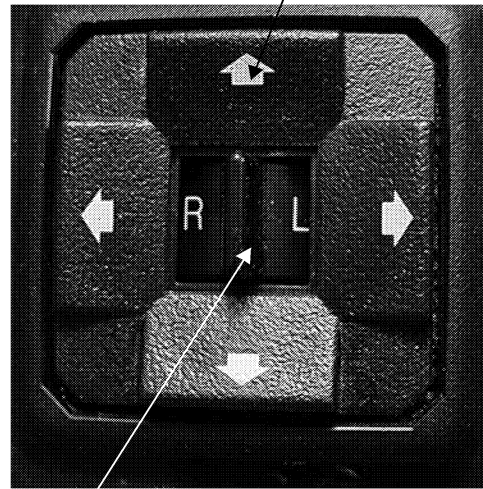

Move L or R to select mirror, or center for “neutral”.

If you cannot adjust the mirror properly using the control switch, the mirror may need a coarse adjustment by repositioning the mirror head. See the mirror manufacturer’s instructions in your Owner InfoCase.

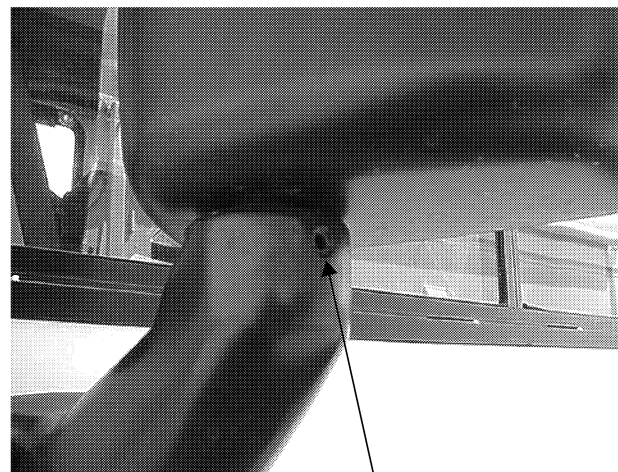

Lock Screw

Driver Side Mirror
Loosen screw to make coarse adjustment

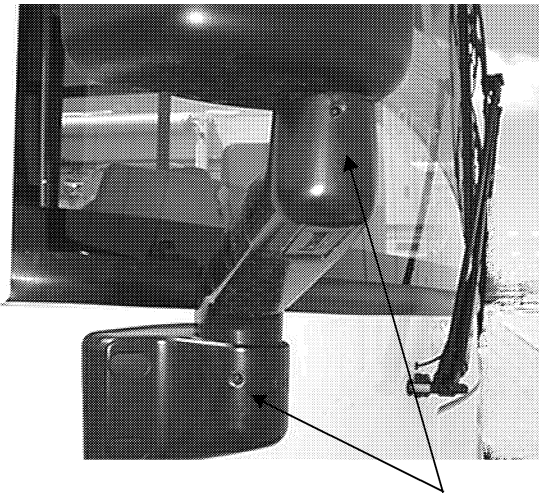

Lock Screws

Passenger Side Mirror
Loosen screws to make coarse adjustments

More Info

To read more about power mirrors, see the mirror manufacturer's information in your Owner InfoCase.

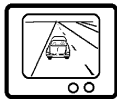

SONY REARVIEW TV MONITOR SYSTEM



Refer to the Owner's InfoCase for specific instructions provided by Sony.

ELECTRONIC COMPASS & OUTSIDE THERMOMETER

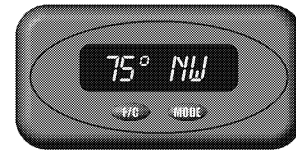

COMPASS OPERATION

The compass has two (2) buttons - MODE and °F/°C - which are used to change the unit between the various operating modes.

Ignition On Operation:

1. Unit displays outside temperature and compass heading.
2. Press the °F/°C button to toggle between displaying °C and °F.
3. If the unit has been properly calibrated, the heading will remain 'on' continuously. If the unit does not have a valid calibration, the heading and the word 'CAL' will flash continuously.
4. If the temperature reading is valid, the temperature display will remain 'on' continuously. If the temperature reading is invalid (due to an open or shorted temperature sensor), the temperature reading will flash continuously.
5. Unit goes to SLEEP MODE when ignition is turned off.

Sleep Mode Operation:

1. Unit enters SLEEP MODE when ignition is turned off.
2. The display is blank and the unit is in a LOW POWER MODE.
3. Unit wakes from SLEEP MODE and enters:
 - A. Ignition ON operation when the ignition is turned on, or
 - B. CAMPING MODE when the °F/°C or the MODE button is pressed for three (3) seconds.

Camping Mode Operation:

1. Unit enters CAMPING MODE after the °F/°C button or MODE is pressed for (three) 3 seconds while in SLEEP MODE.



- Unit displays temperature and heading for ten (10) seconds; the display stays 'on' if you continue to push either button and then returns to SLEEP MODE ten (10) seconds after the last button was pushed.

Nighttime Dimming:

The display brightness is lowered by 50% when the vehicle headlights are turned on.

Calibration:

NOTE: The calibration procedure requires you to drive your coach in a circle during calibration mode, so you will need to be in a large area clear of obstacles, such as a vacant section of a parking lot.

The compass must be calibrated after its initial installation and anytime the compass sensor is replaced or relocated. The calibration values are saved in EPROM memory, so it is not necessary to recalibrate if the battery is disconnected.

Calibration Procedure:

(Best performed in empty parking lot)

- Press and hold the MODE button until the words 'ZONE' and 'CAL' appear (approximately ten (10) seconds). The unit will display the current zone value.
- Press the °F/°C button to increment the zone value.
- Press the MODE button to store the zone value.
- The unit now displays the word 'CAL'. Press the °F/°C button to enter the calibration mode. The display will begin counting down from 60 seconds and the work 'CAL' will flash. Drive slowly in a circle during the 60 second calibration period. If the calibration procedure fails, the unit will flash the word 'CAL' continuously. If the calibration procedure is successful, the unit will display the work 'CAL' for five (5) seconds and then return to normal ignition 'on' operation.

ZONE ADJUSTMENT

When you travel outside the zone, the unit is currently set 'on', the compass has reduced accuracy. To achieve maximum accuracy, it is recom-

mended to change the zone setting when traveling to a new zone in the U.S. To change the zone setting, follow steps (1.) through (3.) of the CALIBRATION ROUTINE, at which point the unit will display the word 'CAL'. Press the MODE button again to skip calibrating. It is not necessary to recalibrate the compass when you change zones.

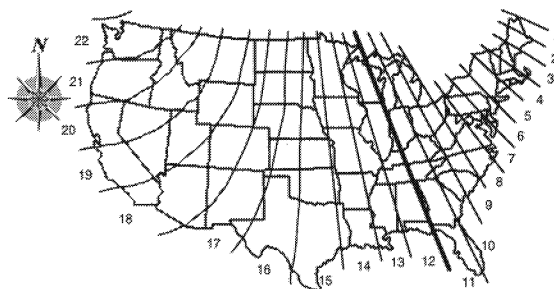

Compass zones for the U.S.

SPECIFICATIONS

Parameter	Min	Avg Typ	Max	Units
Operating Voltage	9	12	18	Volts
Operating Temperature	-40	-	85	°C
Storage Temperature	-55	-	105	°C
Supply Current @12V				
Active Mode		0.3		Amps
Sleep Mode		0.001		Amps
Compass Accuracy	+/-5			Degrees
Compass Resolution			45	Degrees
Temp. Measurement Accuracy	+/-1			°C
Temperature Display	-40		127	°F
	-40		53	°C

REMOTE CONTROLLED SPOT/FLOOD LIGHT - Optional

If your coach is equipped with the remote controlled spot/flood light option, the light is controlled by a hand-held remote control unit included in your Owner InfoCase. This convenient features allow you to operate the spotlight without having to be in the driver seat. You can operate it from anywhere inside that coach, and even while outside the coach for a limited distance.

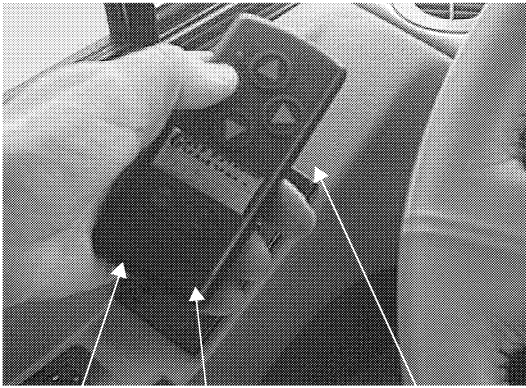

On/Off
Button

Spot/Flood
Focus

Directional
Controls
L-R/Up-Down



Lift to Recline



SEATS

The driver and co-pilot seats may be independently adjusted to suit individual preference.

The seats may be swiveled to provide easy entrance and exit. The swivel feature also allows the seats on most models to be turned toward the living area for additional seating while the unit is parked.

WARNING

Do not adjust driver's seat while vehicle is in motion.

After adjusting seat, always use body pressure to make sure slide and swivel locking mechanism have engaged.

DRIVER SEAT

To Recline Seat: Lift recliner release lever. Lever is located on lower left side of seat.

To Swivel Seat: Pull swivel release paddle outward. Paddle is located on lower right side of seat.

6-Way Power Seat Controls

The power seat controls are located on the lower right hand side of the driver seat base.

To Face Driver's Seat Rearward:

Manual Seat

- Tilt the steering wheel all the way up and extend the telescoping column all the way out.
- Put the left armrest down.
- Swivel the seat to the right until it just contacts the steering wheel, then slide the seat forward all the way.
- Lift the recliner lever and let the seat back



tilt forward to clear the steering wheel.

- Swivel the seat the rest of the way to face the living area.
- Position the tilt wheel down and the column all the way in to provide maximum clearance to recline the seat.
- Reverse the procedure to face the seat forward again.

Power Seat

- Tilt the steering wheel all the way up and put the left armrest down.
- Move the seat rearward fully and then forward a few inches.
- Swivel the seat to the right until it just contacts the steering wheel, then move the seat forward all the way to clear the steering wheel.
- Swivel the seat the rest of the way to face the living area.
- Collapse the steering column all the way and position the tilt wheel down and to provide maximum clearance to recline the seat.
- Reverse the procedure to face the seat forward again.

Armrest Adjustment

The armrests may be swung upward out of the way for easy exit or access to the front seats. A lever at the front of the armrest also lets you adjust the resting angle for personal comfort, whether the seat is upright or reclined.



Lift lever to adjust armrest angle



Armrest shown located for recline position

PASSENGER “BUDDY” SEAT

To Recline Seat: Pull recliner release paddle outward. Paddle is located on lower left side of seat.

To Slide Seat: Pull slider paddle outward. Paddle is located on lower left side of seat.



Pull Outward to Slide

Pull Outward To Swivel

Passenger Seat

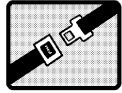

SEAT BELTS

Seats intended for occupancy while the vehicle is in motion are equipped with seat belts for the protection of the driver and passengers. The lap belts must be worn as low as possible and fit snugly across the hip area. Always sit erect and well back into the seat. To gain full protection of the safety belt, never let more than one person use the same safety belt at any one time, and do not let the safety belts become damaged by pinching them in the doors or in the seat mechanism. After any serious accident, any seat belts which were in use at the time should be replaced.

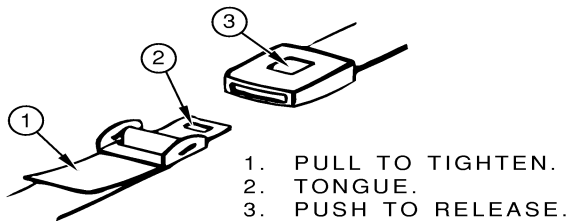

Adjustment: To lengthen belt, turn tongue at a right angle to belt and pull to desired length. To shorten, pull loose end of belt.

To Fasten: Be sure belt is not twisted. Grasp each part of the belt assembly and push tongue into buckle. Adjust to a snug fit by pulling the loose end away from the tongue.

To Release: Press button in center of buckle and slide tongue out of buckle.

WARNING

Snug and low belt positions are essential. This will ensure that the force exerted by the lap belt in a collision is spread over the strong hip area and not across the abdomen, which could result in serious injury.

Only seats equipped with seat belts are to be occupied while vehicle is in motion.



THREE-POINT LAP-SHOULDER BELTS

The driver and co-pilot seat belts in your coach are equipped with automatic locking retractors that let you easily adjust your seat belt to the proper length for passenger safety.

Fastening:

- Grasp the belt just behind the tongue using the hand nearest the door or sidewall. Be sure the belt is not twisted before fastening.
- Pull the belt smoothly outward from the wall and across your body, then insert the tongue into the buckle on the aisle side of the seat until it locks with a positive “click”.
- Feed any excess belt length back toward the wall so the belt retractor will lock the belt at the proper length for your body when released.
- The lap belt portion must be worn snug and low across the pelvic area.
- The shoulder strap portion must be worn diagonally across the chest and over the shoulder, but not against the neck.

NOTE: The shoulder belt height can be adjusted to provide the most comfortable position for each individual person's size. To adjust shoulder belt height, press the lever down, select the desired position and release the lever. A ratcheting mechanism will allow the belt to be pushed upward but not pulled downward.



Press lever to adjust shoulder belt height

- Seat belts offer optimum protection only when worn properly on the body and when the seat is in an upright position.

Unfastening:

- Press the release button in the buckle.
- Hold onto the tongue when you release it from the buckle to keep it from retracting too rapidly.

WARNING

Never wear the shoulder belt in any position other than as stated above. Failure to do so could increase the chance or extent of injury in a collision

SEAT BELT CARE AND CLEANING

- Be careful not to damage the belt webbing and hardware. Take care not to pinch them in the seat or doors.
- Inspect the belts and hardware periodically. Check for cuts, frays, and loose parts. Damaged parts should be replaced. Do not remove or modify the belt system.

- Keep belts clean and dry. If the belts need cleaning, use only a mild soap and water solution. Do not use hot water. Do not use abrasive cleaners or bleach. These products may weaken or damage the belts.
- Replace any belt assembly that was used during a severe impact. Replace the complete assembly even if damage is not apparent.



CHILD RESTRAINTS

All 50 of the United States and the District of Columbia now require the use of the child/infant restraint systems for children in vehicles.

A properly installed and secured child restraint system can help reduce the chance or severity of personal injury to a child in an accident or during a sudden maneuver. Children may be injured in an accident if they are not seated in a child restraint which is not properly secured.

A child restraint system is designed to be secured in a vehicle seat by a lap belt or the lap belt portion of a lap-shoulder belt. According to accident statistics, children are also safer when properly restrained in rear seating positions than in front seating positions.

When purchasing a child restraint system:

1. Look for the label certifying that it meets all applicable U.S. Federal Motor Vehicle Safety Standards (FMVSS) or, in Canada, requirements of the Children's Car Seats and Harnesses Regulations (CCSHR).
2. Make sure that it will attach to your vehicle and restrain your child securely and conveniently so that you are able to install it correctly each time it is used.
3. Be certain that it is appropriate for the child's height, weight and development. The instructions and/or the regulation label attached to the restraint typically provides this information.
4. Review the instructions for installation and use of the restraint. Be sure that you understand them fully and can install the restraint properly and safely in your vehicle.



INSTRUMENT PANEL

- | | |
|-----------------------------------|--------------------------------------|
| 1. Rearview Monitor Speaker | 11. Rearview (Backup) Monitor |
| 2. Windshield Wiper/Washer Switch | 12. Cigarette Lighter/12V Socket |
| 3. Aux. Start Switch | 13. Radio/Cassette Player/CD Control |
| 4. Fog Lamps Switch | 14. Automotive Heater/AC Controls |
| 5. Instrument Panel* | 15. TV Antenna Check Light |
| 6. Radio Power Switch | 16. Ignition Switch* |
| 7. Aux. Battery Switch | 17. Park Brake Knob* |
| 8. Aux. Generator Switch | 18. Front Slideout Control Switch |
| 9. Aux. Windshield Fan Switch | 19. Headlight Switch/Panel Dimmer |
| 10. Air Horn Switch | 20. Exhaust Brake On/Off Switch |

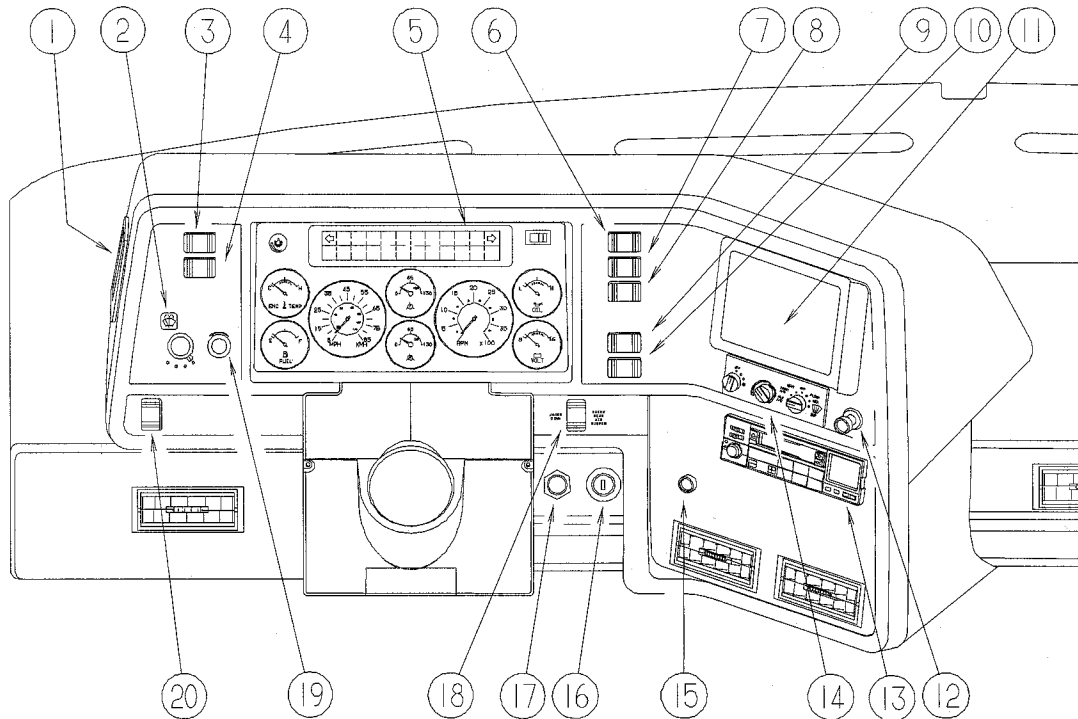

*See your Freightliner chassis operator manual.

NOTE: Some equipment or controls shown may be optional or unavailable on your model.



MULTI-FUNCTION SIGNAL LEVER

The multi-function signal lever controls the turn signals, high/low beam changing, and the electronic speed control (cruise).

See your chassis operating guide for complete operating information.

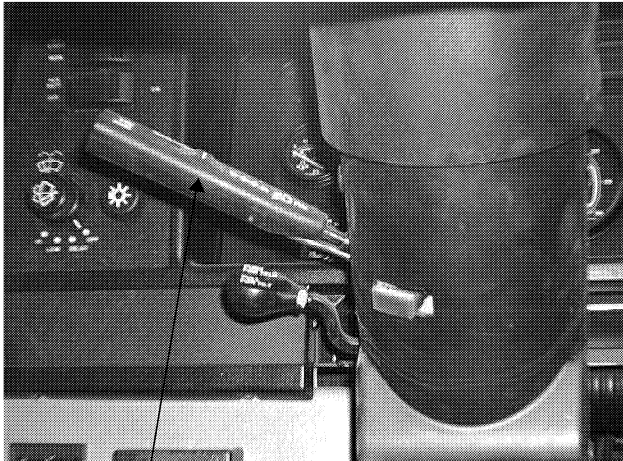

Multifunction Lever
Signals/Hi-Lo Beams/Cruise



HEADLIGHT BEAM CHANGE AND TURN SIGNALS

Move multi-function lever upward for right turn signal and downward for left turn signal.

Pull end of handle toward you to switch high beam to low, or low beam to high.

STEERING TILT/TELESCOPE

The tilt/telescoping adjustment lever is located on the left side of the steering column.

To Adjust Tilt Wheel: Pull the lever toward you and tilt the steering wheel to the desired angle, then release the lever.

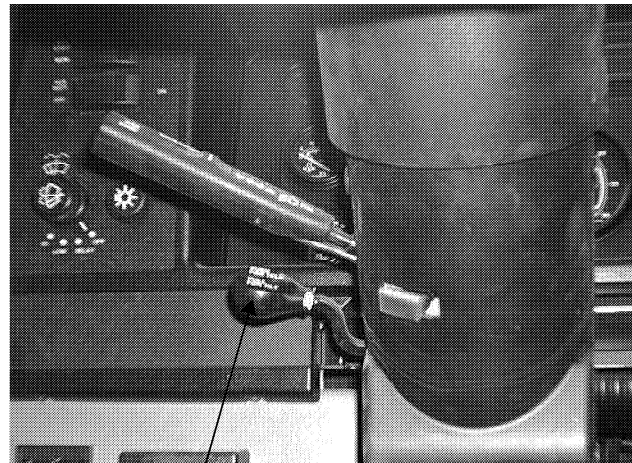

Pull to Tilt
Push to Telescope

To Adjust Telescoping Column: Push the lever toward the dash. Push or pull the steering wheel to slide the steering column in or out to the desired length. Release the lever to lock the column into position.

WARNING

Do not adjust the steering column or tilt wheel while the vehicle is in motion. This could cause a loss of vehicle control.

CRUISE CONTROL

The electronic speed control (cruise) allows you to maintain a steady speed and relieve driving strain while traveling long distances.

See your Freightliner chassis operator manual for complete instructions and precautions on the cruise control.

WARNING

Do not operate the cruise control on icy or extremely wet roads, winding roads, in heavy traffic, or in any other traffic situation where a constant speed cannot be maintained.



WINDSHIELD WASH/WIPE SWITCH

Wash: Press the control knob to pump washer solution onto the windshield. The wiper will also begin operating. The wiper will continue for 5 wipes after you release the washer knob.

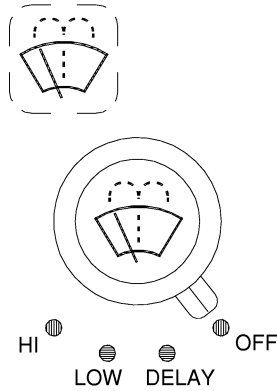

Wiper: Rotate the outer knob pointer to the desired setting - Delay, Low or Hi.

Delay: Turn the outer knob pointer to “DELAY”. Turn the center (wash) knob to set the time you want between wipes, from 1 second (all the way left) to about 90 seconds (all the way right).

COMFORT CONTROLS



AUTO AIR CONDITIONER/ HEATER

Controls for the air conditioner, heater, defroster and vent are all combined into one control panel. Refer to the following instructions for use of individual controls.

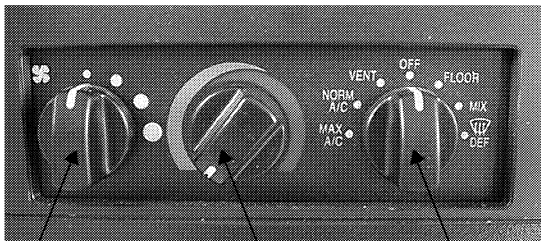

Fan Speed
Control

Temp
Control

Mode
Selector

1. Front Heater Fan Switch
2. Temperature Control Knob
3. Mode Selection Knob

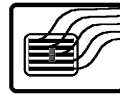

HEATING

- A. For maximum heating
 1. Turn the mode selection knob to HEAT or VENT.
 2. Turn the temperature control knob to WARM (red) zone.
 3. Place the fan switch to high (largest dot).
- B. For reduced heating:
 1. Turn the temperature control knob toward the COOL (blue) zone to the desired comfort position.
 2. Adjust the fan speed for desired volume.



DEFROSTING

- A. For maximum defrosting and defogging:
 1. Turn the mode control knob to DEF.
 2. Turn the temperature control knob to WARM (red).
 3. Turn the fan switch to high (largest dot).
 4. Turn on auxiliary (windshield) fans if additional air movement is needed
- B. For reduced defrosting:
 1. Turn the temperature control knob to the left to an intermediate setting.
 2. Adjust the fan speed for desired volume.

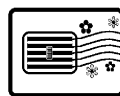

VENTILATION

- A. To vent outside air into the vehicle when neither heating or cooling is required.
 1. Turn the mode selection knob to vent.
 2. Turn the temperature control knob all the way to the left to the COOL (blue) zone.
 3. Adjust the fan speed for desired volume.



AIR CONDITIONING

- A. For maximum cooling.
1. Turn the mode selection knob to MAX A/C.
 2. Turn the temperature control knob all the way left to the COOL (blue) position.
 3. Turn the fan speed switch in to high (largest dot).

OFF

When no heating, cooling or defrosting are required:

1. Turn the mode selection knob to OFF. This will shut off the fan and prevent outside air from entering the unit.

NOTE: The automotive air conditioner is not designed to cool the entire interior of the motor home, but is intended to cool the driver's compartment only.

⚙️ **ENERGY TIP:** Turn off any electrical items or accessories (lights, fans, defoggers, etc.) when not being used. This reduces fuel consumption by cutting down electrical load on the automotive alternator. The more electrical items being used, the greater the electrical “pull” on the alternator, which causes the engine to work harder and use more fuel.

ANTENNA CHECK LIGHT

The antenna check light will come on for 20 seconds when the ignition switch is turned on to remind you to be sure the TV antenna is lowered completely into the roof cradle for travel storage.

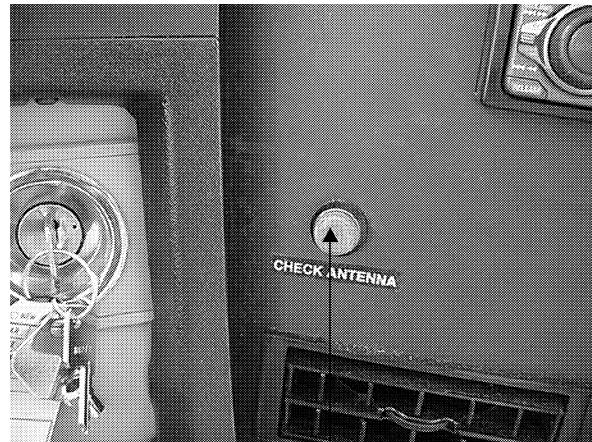

“Check Antenna”
Light



STEREO SOUND SYSTEM

**Radio Cassette Player (Standard) or
Radio Compact Disc Player (Optional)**

Your coach may be equipped with a standard AM/FM stereo radio cassette player or an optional AM/FM stereo radio/CD player. Both of these systems provide high quality stereo sound for your listening enjoyment while traveling or parked.

Refer to the individual radio manufacturer’s information supplied in your InfoCase for detailed operating and care instructions.

Radio Power Switch

The radio power switch lets you connect the dash radio to the coach batteries with the ignition switch turned off for listening while parked. This prevents accidental draining of the chassis (starting) battery during prolonged operation of the radio.

Deluxe Sound System

Your coach may be equipped with a deluxe sound system featuring special high-output cube speakers and subwoofers to enhance your listening enjoyment.



- Place the Radio Power Switch in AUX position and the Ignition Switch in ACC position.
- A speaker selector switch in the Video Center lets you switch the deluxe speakers to your desired sound source, whether the dash radio or the TV and VCR for theater sound listening.



Deluxe Sound Speaker Selector
(In right front overhead compt.)

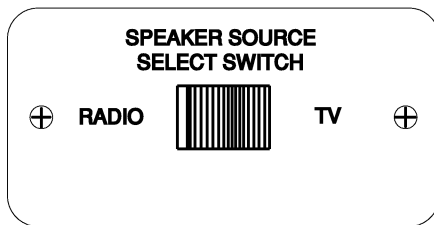

COMPACT DISC CHANGER - Optional

The remote CD changer is located out of sight in the driver side overhead front cabinet. The changer cartridge holds up to 10 compact discs for many hours of listening enjoyment. The CD changer is operated with a hand-held remote control unit, which transmits through the CD changer display face in the dash. The remote control unit is included in your Owner InfoCase.

See the Compact Disc Changer System operating guide in your InfoCase for complete operating instructions and basic troubleshooting.



AUX. START SWITCH

This switch can be used to provide emergency starting power from the motor home auxiliary battery if the automotive battery is discharged.



Press while turning ignition key for emergency starting power if engine battery is dead.

AUXILIARY BATTERY (Aux. Batt) SWITCH

The AUX BATT switch disconnects the auxiliary (coach) batteries from the 12-volt system of your coach to avoid long-term battery drain by electrical items that are hooked directly to the coach batteries.

Always leave this switch ON except during long storage periods (a month or more).



CB RADIO WIRING
(Optional)

Your coach is pre-wired for CB radio installation. The wires are located beneath the dash to the left of the steering wheel.

Look for a pair of wires, yellow (+) and white (-), with connectors and flag labels, suspended from the wiring harness.

Be sure to read the wire labels before installing a CB radio. The labels contain important information and cautions.



CB Wires
(in plastic sheath)

SWR Adjustment

To adjust CB antenna SWR (standing wave ratio), turn the adjusting rings of the antenna to achieve the lowest SWR reading. This procedure will help optimize transmitting and receiving capabilities of the radio system.

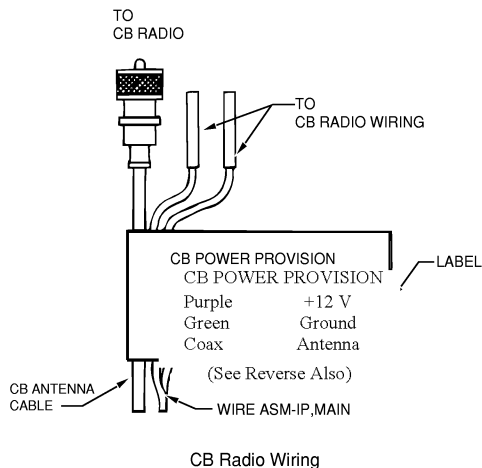

TO ADJUST:

CHECK SWR. ON
CH. 1 & CH. 40.

IF **CH. 1** IS
HIGHER THAN CH.
40 TURN TUNING
RING **CLOCKWISE.**

IF **CH. 40** IS
HIGHER THAN CH.
1 TURN TUNING
RING **COUNTER-**
CLOCKWISE.

USUALLY ¼ – ½
TURN IS ENOUGH.

REPEAT UNTIL
CH. 1 & 40 ARE
THE SAME.

DO NOT TRIM
WHIP.

TUNING
RING

CAUTION

The CB radio could become damaged if CB antenna SWR is not adjusted before operating CB radio.



HYDRAULIC COACH LEVELING SYSTEM

Your coach may be optionally equipped with a 4-point HWH hydraulic leveling system.

This leveling system is designed to diminish problems in selecting a parking site, making “set up” easier and faster for you.

See the HWH Operator Manual in your Owner’s InfoCase for complete operating instructions. It also contains additional precautions, technical information, and instructions for manual operation if automatic functions fail.

The leveling system control panel is located on the driver’s side armrest panel.



Leveling System
Control Panel

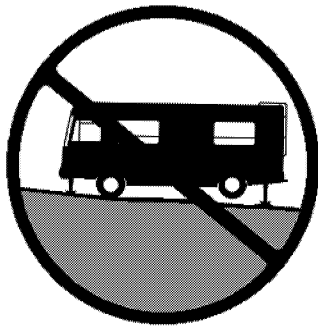

NOTE: When parking at an uneven site, always park the front of the motor home to the downhill side. This allows you to level by raising the front end rather than the rear. Since only the rear wheels are locked while in PARK, raising either one or both of the rear wheels off the ground could allow the vehicle to roll off the jacks.

CAUTION

Do not try to drive vehicle unless 'TRAVEL' light is glowing with ignition switch on.

Do not try to drive the vehicle until the air suspension system has built up sufficient pressure if you have used the coach leveling system or have used the DUMP button to manually exhaust the air suspension system.

WARNING

Keep all people clear of the coach while the leveling system is operating.

Do not use leveling jacks to support vehicle for service or tire changing.

Further Information

See the HWH Operator Manual supplied in your Owner InfoCase. It contains detailed instructions, precautions and technical information. It also contains troubleshooting instructions for operating system if any functions fail.

NOTE: If one of the leveling jacks should fail to retract, it can be normally retracted by opening a T-handle valve on the reservoir side of the hydraulic pump. The jacks are spring loaded to retract when hydraulic line pressure is relieved. See the HWH Operator's Manual included in your InfoCase for specific instructions on which valve to open and what precautions to follow. The hydraulic pump may be mounted facing a different direction than shown, depending on model. Valves will be in same relative positions.

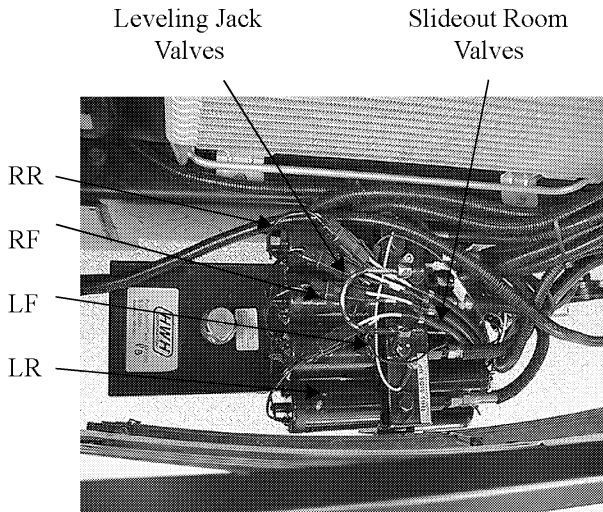

Leveling/Slideout System Hydraulic Pump
(Note valve positions in relation to fluid reservoir)

Turn T-handle out about six turns until fully open.

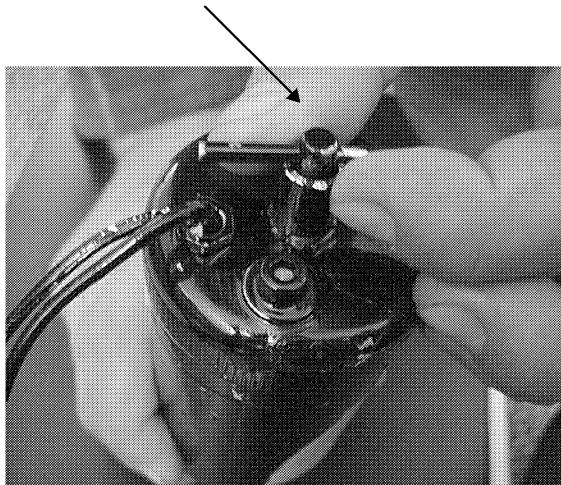

Leveling Jack Solenoid Valve

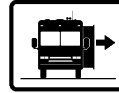

SLIDEOUT ROOM EXTENSION

CAUTION

Release galley slideout room travel latches before attempting to extend galley slideout room. Fasten travel latches before driving vehicle. See the following instructions.

Your coach is equipped with a galley/living room slideout extension to enlarge your living area at the push of a button. The slideout room extends and retracts by hydraulic mechanisms with an electronic control system.

The lounge slideout switch is located on the lower right dash bezel.

Travel Straps (Front Slideout Room)

The Travel Straps **must be released before attempting to extend the room** or damage to the coach will result.

The travel straps are designed only to help keep the room extension secured against the coach sidewall to maintain an effective weather seal while the vehicle is in motion. They are not designed to withstand the force exerted by the hydraulic extension mechanism and will not prevent extension of the room.

Travel straps are located on the floor near the ends of the slideout room.

To Release:

- Pull the strap buckle outward and up to release tension on strap.
- Pull a short length of the excess strap back through the buckle to provide sufficient slack.
- Unhook the strap end pegs from the mooring brackets on the floor and wall edge. Store straps in location of your choice. (Under the couch is one choice.)



To Fasten Straps:

- Hook the strap end pegs into the mooring brackets.
- Flip buckle downward and press toward strap until it “snaps” snugly into place against the strap.
- If a strap is loose or too tight after closing the buckle, release the buckle and pull the loose end of the strap in or out to adjust tension as needed. Then reclose the buckle.

WARNING
Keep all persons clear of the slideout room and moving parts while extending or retracting. Do not occupy the slideout room while it is being extended or retracted.

To Extend SlideOut Rooms:

CAUTION
Check to be sure the exterior storage compartment doors below the slide-out room extension are closed before extending or retracting the room to avoid possible damage to the finish of the doors.

- Level the coach.
- Set the Parking Brake. An interlock relay system will then provide power to the slide-out control switches.
- Release travel straps (galley).
- Press slide-out switch and hold until room is fully extended, then release switch.
- The front slideout control switch is located on the lower right dash bezel, above the ignition key and park brake knob.



Lounge Slideout Switch

Before Retracting Slideout Room

If it has rained recently before you retract the slideout room, we recommend using the hydraulic leveling system to lean the coach and drain off any excess water possibly remaining on the roof before retracting. Lean the coach slightly to the left (driver’s side) as shown by raising both right side jacks to let excess water flow away from the rooftop weatherseal and toward the outside of the slide-out roof.

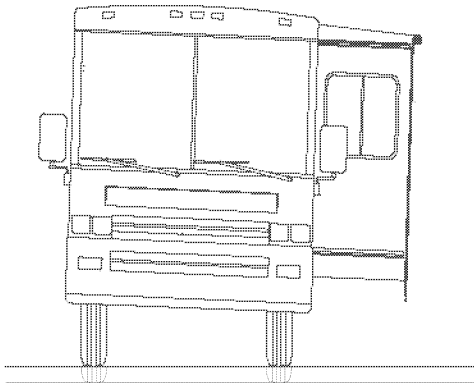

To Retract Slideout Room:

CAUTION

Although there is an awning over the roof of the slideout room, there is a possibility of debris getting onto the roof. Because the slideout roof is drawn into the interior of the coach when retracted, be sure there is no debris, such as excessive dirt, tree seeds, twigs, leaves, etc. on the roof before retracting.

- Remove all items from the coach living room floor. Turn leveling system on to provide power to the slideout control switch.
- Press slideout switch and hold until room is fully retracted, then release the switch.

High Wind Precaution

We remind you to be aware of high winds while the room is extended because of the effect they can have on the roof awning. It is a good idea to retract the room any time high wind conditions would also make it necessary to roll in the patio side awning. This will protect the slide-out room awning from possible wind damage.

If Slideout Room Will Not Operate (Troubleshooting)

- The chassis battery may be low on charge. Press the Aux. Start switch on the dash to the momentary (MOM) position while pressing the slide-out control switch. This momentarily connects the coach batteries to assist in retracting the room.

- One of the fuses may be blown. Fuses are located on the interior firewall beneath the dash, beneath the instrument panel dash pod, and inside the leveling control pad housing. Unfasten the control pad from the driver side armrest panel to inspect the fuse.
- If the batteries and fuses are okay, there may be a failure in the hydraulic system or electrical system. See “Emergency Crank-In Instructions” below for help.

Front Slideout Room Emergency Crank-In Procedure (Use only when slideout room will not retract using control switch)

If a failure occurs in the slideout electrical or hydraulic systems, and the room will not retract using the control switch, you can manually crank the room in using an emergency winch system described below. The winch is stored in a cargo compartment on the passenger side of the coach.

Step 1 - Relieve Hydraulic Line Pressure

- Open the hydraulic pump slideout solenoid-valves to release hydraulic line pressure and let fluid bypass into the fluid reservoir. The pump is located behind an access cutout in the large cargo compartment below the slide-out room on the driver side of the coach.

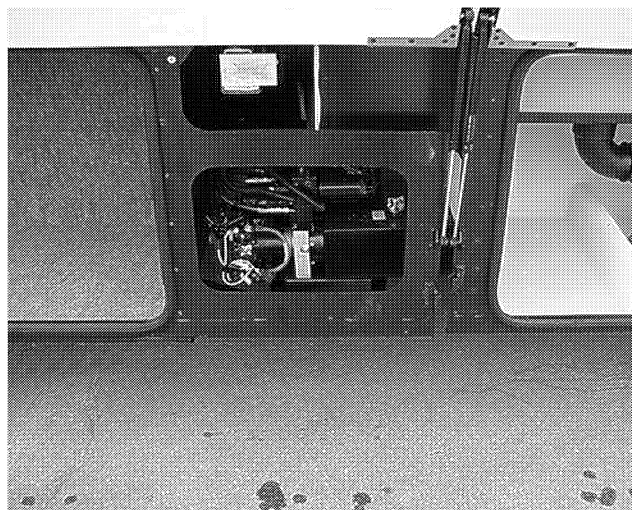



WARNING
Stop engine, place transmission in park position and apply parking brake before lying beneath vehicle for this procedure.

*NOTE: The hydraulic pump is equipped with two types of hydraulic solenoid valves shown. The **leveling jack** solenoids have a **T-handle** on the valve shaft that can be turned by hand. The **slideout room** solenoid has a small 1/4" nut at the end of the valve shaft that requires you to use a 1/4" nut driver tool that is provided in your InfoCase.*

See the HWH Operator's manual included in your InfoCase for specific instructions on which valves to open for front or rear slideout rooms and what additional precautions to follow.

- Open the two slideout solenoid valves (with 1/4" nuts on the ends) on the motor end of the pump to relieve hydraulic line pressure. (See Step 1 under "slideout Room Emergency Crank-In" on previous page.) **DO NOT LOOSEN NUTS MORE THAN 4 FULL TURNS.**

Use provided 1/4" nut driver to turn nut counterclockwise 4 turns only.

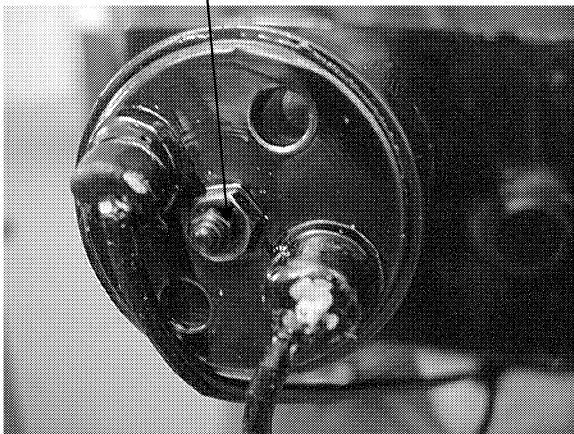

Slideout Room Solenoid Valve

- Do not open any of the four large T-handled valves on the opposite end of the pump. These regulate the coach leveling jacks.

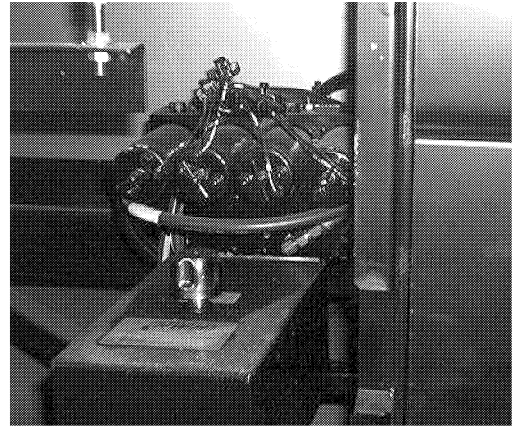

Leveling Jack Valves - Do Not Open

Step 2 - Attach Winch and Crank Room Inward

- Remove the register from the floor heat duct and anchor the winch in the floor. Insert the winch retainer bracket into the duct cutout in the floor as shown.

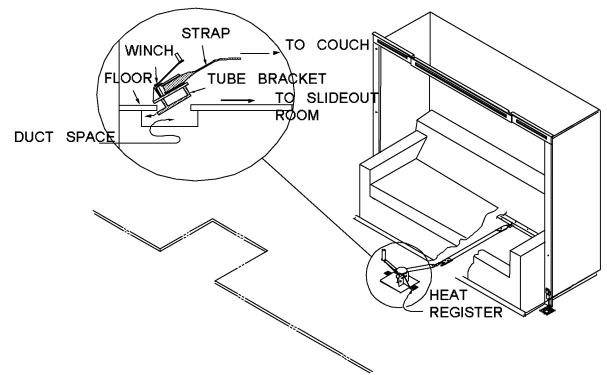

NOTE: Be sure the bracket extensions face away from the slideout room as shown for proper support while cranking.

*NOTE: **Banquette Option only:** If your coach is equipped with the banquette option, the winch will not have a floor duct bracket. The winch is anchored using a belt provided beneath the banquette, which attaches to the "tail strap" on the winch assembly.*



- Insert the winch strap hook into the sewn loop end of the strap beneath the couch.
- Be sure the winch ratchet pawl is in the locking position (against the gear teeth) before cranking.
- Crank the winch handle clockwise slowly, a few “clicks” at a time, until the room is fully retracted. **Allow about 10 minutes to crank room in fully.**

NOTE: Attempting to crank the room in too quickly will raise pressure in the hydraulic fluid lines and make cranking more difficult.

- Unhook the winch and return the winch and straps to storage locations. Release the strap by putting slight pressure clockwise on the crank handle, then moving the ratchet pawl to the free-wheel position (away from gear teeth).

Step 3 - Secure Travel Straps and Close Hydraulic Line Valves

- Fasten the slideout room Travel Straps as shown.
- Close the slideout solenoid valves completely.

NOTE: Close the valves snugly, but do not overtighten. Overtightening may cause internal damage to the valves.

- See your dealer for service of the room extension system before using again.

Bedroom Slideout Emergency Retraction

In the unlikely event that your bedroom slideout fails to retract using the power switch, check for obvious causes first, such as low charge on the house batteries, or a burned out fuse on the chassis fuse block. (See “Troubleshooting” on page 2-21.)

NOTE: Check fuses #16 Step Alarm and #24 Radio/Acc. There is also a fuse on the back of the HWH leveling system control pad,

which must be unfastened from the driver door to inspect.

If an apparent cause is not found, call the number on your Winnebago Industries Premium Roadside Assistance card. They will dispatch a service vehicle to your location to push the room extension in so the coach may be driven to your dealer for service of the slideout control system.

NOTE: The following information may be needed by the service operator to prepare the bedroom slideout for the “push-in” procedure.

Bedroom Slideout Emergency ‘Push-In’ Procedure

- Open the “slideout” hydraulic line valves on the pump to relieve hydraulic line pressure. (See Step 1 under “Slide-Out Room Emergency Crank-In” on previous page.)
- **DO NOT OPEN THE JACK VALVES ON THE RESERVOIR SIDE OF THE PUMP.** *These regulate the coach leveling jacks.*
- Apply a steady inward pressure of approximately 150 lbs. to the exterior sidewall of the slideout room to push the room in toward the coach until it is snug against the main coach sidewall.
- *NOTE: Use some type of rigid, padded material to protect the sidewall from punctures, dents or other damage to the finish from any device or equipment used to press the sidewall in.*
- Pressure must be applied evenly to avoid binding of the hydraulic mechanism. It may take about 10 minutes to press the room extension inward completely.
- When the room is snug against the coach wall, close the solenoid valves to prevent “creep out” during transit.
- See an authorized Winnebago Industries dealer for service of the slideout control system.

See your Authorized Winnebago Industries Dealer for service of the slideout system before using again.



NOTE: When the system has been corrected, check hydraulic fluid level and refill reservoir as necessary. Press the Retract switch for 15 to 20 seconds before attempting to extend the room. Then run the room out and in several times to purge any air from the hydraulic system. Finally, recheck fluid level and fill as necessary.

Further Information

See the HWH Hydraulic Room Extension operating guide included in your Owner's Info-Case for further instructions and troubleshooting information.



HAZARD WARNING FLASHER

The hazard warning flasher provides additional safety when the vehicle must be stopped on the side of the roadway and presents a possible hazard to other motorists. When the flasher is on, it serves as a warning to the other drivers to approach and overtake your vehicle with caution.

WARNING

Operating the hazard warning flasher system while moving on the highway is illegal.

The front and rear turn signals will flash intermittently when the flashers are in operation. When it is necessary to leave the vehicle, the flasher system will continue to operate with the ignition key removed.

See page 2-3 for information on operating the hazard warning flashers.



IF YOU GET A FLAT TIRE

In case of sudden tire failure, avoid heavy brake application. Gradually decrease speed. Hold steering wheel firmly and move slowly to a safe, off-road place. Park on a level spot, set the parking brake, turn off the ignition, and turn on the hazard warning flasher system.

Emergency Road Service

Because of the size of this vehicle and the possible complications involved in tire changing, this coach is not supplied with a spare tire. If you experience a tire related road emergency, call the number on your Winnebago Industries *Premium Roadside Assistance* card. A tire center road service unit will be quickly dispatched to your location to service your tire on the spot. A quali-

fied tire center road service unit has the necessary equipment and expertise to handle road tire emergencies quickly and safely.



RECOVERY TOWING

When calling a professional towing service, we recommend that you advise them of your coach length and approximate front axle weight. This will allow the towing operator to determine the proper towing equipment to use. (This information is found on the vehicle certification label located to the left of the steering wheel.)

We recommend that you ask for an underlift (wheel lift or frame lift) type towing assembly for safe towing.

Winnebago Industries does not assume responsibility for damage incurred while towing this vehicle.

NOTE: Consult the Freightliner chassis operating guide for any additional towing instructions or precautions provided by the chassis manufacturer.

CAUTION

Do not lift on bumper. Damage will result to front end body parts.

WARNING

Stay out from beneath the motor home while it is suspended by the towing assembly unless the vehicle is adequately supported by safety stands. Do not allow passengers to occupy a towed vehicle.

NOTE: Know and obey all state and local towing regulations. Tow at reduced speed.



JUMP STARTING

If your coach will not start from the automotive batteries, try using the aux. start switch to divert power from the coach batteries to the starter. (See Aux. Start Switch on page 2-14.) If you wish to try jump starting the engine using another vehicle or booster system, here are basic guidelines for connecting jumper cables to automotive electrical systems.

WARNING

Automotive batteries produce caustic acid, explosive gases, and electrical current which may cause burns. It is important that the instructions below are followed **exactly**, or personal injury (particularly to eyes) or property damage may result due to battery explosion, battery acid, or electrical (short circuit) burns.

- NEVER smoke near the battery or expose it to open flame or electrical sparks.
- Wear eye protection or shield your eyes while working near battery, in case an explosion does occur. NEVER lean over a battery.
- Do not allow battery fluid to contact eyes, skin, clothing, or painted surfaces. Immediately flush any contacted area with water. If eyes are affected, seek medical help after flushing.
- Remove all metal jewelry to lessen the risk of a short circuit occurring.

2. Position the vehicle with the good battery so that the jumper cables will reach, but **do not allow the vehicles to touch.**
3. Turn off all electrical accessories, motors, and lights except those needed for safety or to light up the work area. Place automatic transmission in N (Neutral) and apply parking brake. Be sure parking brakes are engaged in both vehicles.
4. If the weak battery has filler caps, make sure the electrolyte is at proper level. Add distilled water if fluid is low. If electrolyte is not visible or appears to be frozen - **do not attempt jump starting!** A battery may rupture or explode if the electrolyte is frozen or not filled to the proper level.
5. Connect one end of the positive “+” (red) jumper cable to the positive “+” terminal of the weak battery. Connect the other end to the positive “+” terminal of the charged battery.
6. Connect one end of the negative “-” (black) jumper cable to the negative “-” terminal of the charged battery.
7. Finally, connect the remaining end of the negative “-” (black) cable to a solid, metal grounded location on the engine of the vehicle with the weak battery, at a point at least 18 inches from the battery. Do not connect to any moving parts. **THE MAIN SAFETY PRECAUTION IS TO MAKE THE FINAL GROUND CONNECTION ON THE ENGINE AT A SAFE DISTANCE FROM THE BATTERY. THIS HELPS TO REDUCE THE CHANCE OF EXPLOSION DUE TO SPARKS.**
8. Start the engine of the vehicle with the charged battery, and allow it to run for a few minutes at moderate r.p.m. Then start the engine of the vehicle with the discharged battery.
9. Reverse the above sequence **EXACTLY** when removing the jumper cables. Start by removing the cable from the ground location on the engine first, then continue in reverse sequence.

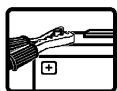

CONNECTING JUMPER CABLES

1. Make sure that the other vehicle has a 12-volt battery and negative ground compatible with your vehicle’s electrical system.



WARNING

Do not attempt to push-start this vehicle. Damage to the transmission or other parts of the vehicle could occur.

CONNECTING A BATTERY CHARGER

To connect a battery charger, first make sure the engine is switched off. Disconnect the positive (+) lead from the battery. Never disconnect the battery while the engine is running or alternator damage could result.

Connect the positive “+” (red) lead of the charger to the positive “+” terminal on the battery. Next, connect the negative “-” (black) lead of the charger to a suitable ground. Finally, plug in or switch on the charger.

To disconnect the charger after charging, unplug the charger from the electrical outlets, remove the charger leads from the vehicle, and reconnect the vehicle leads to the battery.



ENGINE OVERHEAT

If you see or hear steam escaping from the radiator or the engine compartment or have any other reason to suspect an extreme engine overheating condition, pull the vehicle over to the roadside as soon as it is safe to do so, stop the engine and get out of the vehicle.

WARNING

Operating a vehicle under a severe overheating condition can result in damage to the vehicle and may result in personal injury.

An engine will overheat if the water pump drive belt breaks, if the coolant is low or there is a loss of coolant because of one or more of the following:

- a leak in the cooling system
- a hose failure
- water pump failure

Also, be aware of the following situations, which can cause temporary engine overheating:

- climbing a long hill on a hot day
- idling while stopped in traffic for long periods of time
- towing a trailer or automobile
- stopping after a period of high speed driving

If the TEMP indicator on the instrument panel shows a rise in engine coolant temperature while driving, take the following steps to try to lower the overheating:

- If you are using the automotive air conditioner, turn it off.
- If you are stopped in traffic, shift the transmission into N (Neutral), and engage parking brake.

If the temperature does not drop within a minute or two:

- Pull the vehicle over to the roadside as soon as it is safe to do so.
- Place the transmission in N (Neutral) and press the accelerator to increase engine speed (r.p.m.'s) to twice that of normal idle speed, and hold it there for approximately two or three minutes.
- If engine temperature does not go down, turn the engine off and wait until the engine has cooled before opening the engine compartment

When no trace of escaping steam is heard or seen, open the hood to check for the cause of the overheat. Check hose connections and tighten if necessary. Make sure there are no broken belts, pulleys or hoses before adding any coolant to the coolant reservoir.

For further information about overheating, consult your Freightliner chassis operating guide and Caterpillar Diesel Engine manual.



(See also SAFETY PRECAUTIONS, Section 1 of this manual.)



LOADING THE VEHICLE

NOTE: *Your motor home's load capacity is designated by weight, not by volume, so you cannot necessarily use all available space when loading your motor home.*

When loading the vehicle, distribute the cargo load equally so that you do not exceed either the Front or Rear Gross Axle Weight Rating (GAWR) or the Gross Vehicle Weight Rating (GVWR). The Gross Axle Weight Rating (GAWR) means the weight value specified by the chassis manufacturer as the load carrying capacity of a single axle system as measured at the tire-to-ground interfaces. This is the total weight a given axle is capable of carrying. Each axle has its own rating.

Have your vehicle weighed to determine the proper load distribution for your vehicle. Also distribute cargo side-to-side so the weight on each tire or dual set does not exceed one half of the GAWR for either axle.

For example, if the Front GAWR is 6,000 lbs., there should be no more than 3,000 lbs. on each tire. (If the left side weighs 3,100 lbs. and the right side weighs 2,700 lbs., at least 100 lbs. of the load should be shifted from the left side to the right side.) The GVWR is listed on the Vehicle Certification Label. (See page 0-3).

The total combined weight allowed for the vehicle, including trailer towing load weight, is known as the Gross Combined Weight Rating (GCWR). If trailer towing is not recommended, the GCWR will equal the GVWR.

NOTE: *We recommend that you dump all holding tanks before traveling to avoid carrying unnecessary weight.*

CAUTION

The weight of the loaded vehicle (including options, attachments, passengers, water, fuel, luggage and all other cargo) must not exceed the GVWR or GAWR of either axle.

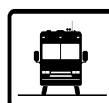

FRONT AXLE TIRE ALIGNMENT

We recommend that you have the front suspension and steering alignment checked and adjusted after you have fully loaded the vehicle according to your needs. Thereafter, have alignment inspected periodically to maintain vehicle steering performance and prevent uneven tire wear.



WEIGHING YOUR LOADED VEHICLE

To check the weight of your fully loaded coach, locate a commercial weighing scale that is capable of weighing large trucks.

Drive the entire coach onto the scale. This weight should not exceed the Gross Vehicle Weight Rating (GVWR) specified on the Vehicle Certification Label near the driver seat. (See sample on page 0-3.)

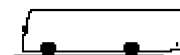

GVWR (Both Axles)



Front GAWR
(Front Axle Only)



Rear GAWR
(Rear Axle Only)



To determine the weight on either front or rear axle, drive that axle only onto the scale. Neither axle weight should exceed the corresponding maximum axle weight rating specified on the certification label.



MAXIMUM OCCUPANCY

The following label is placed in a visible location in the driver compartment.

BELTED SEATING POSITIONS MAY EXCEED SLEEPING CAPACITY OF THIS VEHICLE. SEE OWNER MANUAL FOR OCCUPANCY AND WEIGHT RESTRICTIONS.

The number of belted seating positions in your motor home may exceed the number people used to determine maximum coach occupancy, called the Net Carrying Capacity (NCC) in the U.S. or Cargo Carrying Capacity (CCC) in Canada.

To calculate the NCC or CCC, Winnebago uses vehicle sleeping capacity, however your coach may be equipped with more belted seating positions than sleeping positions to give passengers a choice of seating arrangements. You may use all of the belted seating positions providing you stay within your vehicle's GVWR listed on the Vehicle Certification Label (see page 0-4). However you use or load your vehicle, it is your responsibility to keep the weight within its stated gross vehicle weight rating.



ROOF LOADING

The roof is capable of carrying some light-weight articles while the vehicle is in motion. A roof-mounted luggage carrier designed for this purpose is available from your dealer. However, roof load while the vehicle is in motion is not to exceed 10 pounds per square foot or a maximum of 100 pounds.

When the vehicle is stationary, a cargo load of 100 pounds plus the weight of a 225 pound person to load the cargo or to conduct inspection and maintenance is permissible.

Weight added to both the roof and the trailer hitch contribute to the gross vehicle weight, which must not exceed the vehicle's GVWR.



CAR OR TRAILER TOWING

Freightliner Chassis

Hitch pulling cap.:	5,000 lbs. max
Tongue weight:	500 lbs. max.

The factory installed towing hitch on this coach is rated to pull a 5,000 lb. load (max.), however this does not necessarily mean that you can always tow a 5,000 lb. load. The combined weight of the loaded coach and the towed vehicle could exceed the chassis ratings. Do not exceed either the GVWR, the rear axle GAWR, or the chassis GCWR. *See preceding items "Loading the Vehicle" and "Weighing Your Loaded Vehicle" for explanation of these weight ratings.* Always be aware of the loaded weight of your coach and the weight of any towed vehicle.

Because of individual vehicle use and loading habits, we recommend weighing the vehicle while fully loaded to avoid exceeding any of the listed Gross Weight Ratings. See "Vehicle Certification Label" on page 0-3 for information on gross weight ratings.

Towing will affect vehicle handling, durability and fuel economy. Exceeding any of the listed Gross Weight Ratings will result in unacceptable overall vehicle performance. Maximum safety and satisfaction when towing depends on proper use of correct equipment. A hitch bar of appropriate steel and size should be selected to mate with the Winnebago towing receptor.

Installation of a proper trailer brake system is recommended. Check state regulations on trailer weight and trailer brake requirements to be sure you select the right equipment before towing.



Before descending a steep or long grade when towing a trailer, reduce speed and shift into a lower gear to control vehicle speed. Avoid prolonged or frequent application of brakes which could cause overheating and brake failure.

WARNING

For safety towing and vehicle handling, maintain proper trailer weight distribution.

The total weight of the motor home and the vehicle towed must not exceed the Gross Combined Vehicle Weight rating. Contact the chassis manufacturer to obtain the Gross Combined Vehicle Weight rating for your chassis.

CAUTION

Exceeding any of the recommended gross vehicle weight ratings may result in vehicle damage.

Do not install a frame equalizing type hitch on your vehicle.

See also - Trailer wiring connector, page 6-13.



PRE-TRAVEL CHECK LIST

Before starting the engine to leave on a trip, be sure your motor home has been properly prepared and maintained. This will ensure an enjoyable trip and help avoid delays. Use this checklist as a guide.

- Fluid Levels - Check and fill if necessary:
 - engine oil
 - transmission
 - power steering
 - radiator
 - brake
 - battery
 - windshield washer
- Wheel Lug Nuts - Check for tightness
- Tires - Check for proper cold inflation pres-

ures as specified on the Vehicle Certification Label.

- Drive Belts - Check for proper condition and tension (not cracked, frayed, or loose, etc.)
- 110-Volt Generator (Optional) - Check oil level in generator engine.

WARNING

Never check oil level in generator while engine is operating.

- Fire Extinguisher - Make sure it is fully charged and secured in mounting bracket.
- Lights - Make sure all exterior lights operate.
- Sewer and Water Supply Hose - Unhook and store.
- TV Antenna/Satellite Dish - Make certain the antenna and dish are lowered and seated in their support cradles.
- Loose Items Inside the Motor Home - Store or secure items.
- Pilot Lights - Make sure all pilots are off.
- Fuel Tanks - Check level.
- Water Tank - Fill with fresh water.
- Exterior Door and Step - Make sure doors are closed, locked and step retracted.
- Seats - Adjusted for comfortable position and locked in place.
- Mirrors - Adjust for maximum visibility from driver's seat.

TRAVEL TIPS

As you travel around the country in your motor home, you will pick up useful advice from other motor home owners.

A number of suggestions can also be obtained by reading articles and regular columns in outdoor and camping magazines. Some magazines and publishing companies print an annual park and campground directory. These can be found at your local news stand or RV supply dealer. Here are a few travel tips to begin with.

1. Always check for sufficient clearance. Know the height and width of your unit.
2. Always fill the fresh water tank at an approved potable water filling facility or a known purified drinking water source. Taste the water before filling the water tank in an



unfamiliar location. The water in some areas may contain an undesirable taste. Do not use a new hose to fill the water tank. It can leave a distinct rubber or vinyl taste.

3. Showers can take a lot of water. Conserve water by taking a "Sea Shower". This is done by wetting down, turning off the water, soaping thoroughly and then rinsing.
4. Dump sewage only at approved dumping stations.
5. Store liquids in plastic containers with tight fitting caps to prevent spills.
6. Keep an eye on the water and holding tank levels. It is a good idea to dump the holding tank at least every two days.
7. When traveling with children, it is helpful to plan their wardrobe for a week. Place each days clothing in a plastic bag and label the bag with the child's name and day of the week for use.
8. Use sleeping bags whenever possible. They save laundry and take up less storage space than bedding.
9. Make sure all compartment doors have been closed and the door step has been stowed in the correct position before moving the vehicle.
10. Before traveling, make sure the refrigerator door has been secured. Use care when opening the refrigerator door after the vehicle has been stopped. Any articles that have shifted may fall out when the door is opened.
11. During peak tourist season and holidays, it is best to phone ahead and make reservations at the park where you plan to stop.
12. Some states or cities will not permit vehicles with LP gas containers to pass through highway tunnels. If your route includes a tunnel, check with the highway patrol or department of highways to avoid inconvenience.
13. Do not leave food or odor-causing material in your vehicle for extensive periods of time. Always allow damp clothing, swimwear, hunting gear, etc., to dry before stowing.
14. Become familiar with the fire extinguisher and make sure it is always fully charged. Remove and replace it and read instructions so you know the correct operating procedure before an emergency happens
15. Make a list of all groceries, fresh meats, vegetables, newspapers, etc., that you may need and try to pick them up during your last fuel

stop of the day. This will prevent leaving a good parking spot once you have arrived at your destination.

16. When you sit over the front wheels while driving, as in a motor home, you have a tendency to crowd the middle of the road. Check the side view mirror frequently to observe how close you are driving to the center line.



SEVERE WEATHER INFORMATION

One of the more serious conditions affecting the motor home traveler and camper is that of the weather. Whether you travel the high mountain terrain, the lower deserts and flatland or the plains of the midwest, the weather is always with you and subject to change, sometimes with little or no warning. However, adequate warnings are normally broadcast over local radio and TV stations.

Motor home travelers and campers often seek secluded areas for weekend recreation or extended summer vacations. Many recreational areas are vulnerable to severe weather situations, especially flash flooding conditions. A few simple precautions may help lessen the hazards of flash flooding or reduce your immediate involvement.

NOTE: We recommend that all motor home occupants become familiar with these safety precautions, and be alert to change in weather.

- Be alert, because thunderstorms can form at any time, in any month of the year. Thunderstorms can produce large amounts of rain over a small area in a short time, which may result in a flash flood. Listen frequently to weather reports on the radio for weather and flood conditions.
- When camping near a stream, leave plenty of sloping bank between you and the stream.
- Avoid deep canyons and dry washes during stormy or threatening weather. Be aware of alternate exits.



- If heavy rain occurs, move to high ground immediately (at least 30-40 feet above the canyon floor or bottom of dry wash).
- During a flash flood, if you cannot move your vehicle, abandon it. Do not attempt to return to your vehicle before the water has receded.
- Do not attempt to wade to your vehicle if the water is above your knees - fast moving water exerts an enormous amount of pressure, making it impossible to remain standing or walking.
- Do not try to drive through flooded areas.
- Follow instructions of local authorities. Leave immediately when advised to do so. Many lives have been lost because people did not heed warnings.
- Have on hand survival supplies for several days, including food, water, first aid equipment and necessary medications. In desert areas during hot weather allow 3-4 gallons of drinking water per person, per day.
- Before you leave home, inform someone of your destination and when you expect to return. Authorities at your destination should be notified immediately if you do not arrive on time.

REMEMBER THESE TERMS:

WATCH: Severe weather may develop in the specified area. Be alert and prepare for possibility of an emergency.

WARNING: Severe weather is occurring or is imminent in certain areas. Move to a safe location immediately.

We highly recommend that you obtain a weather radio. These radios offer up-to-date weather reports. The latest information and forecasts are broadcast by local National Weather Service offices in recorded messages that last from three to five minutes. These messages are replayed continually 24 hours a day. The record-

ed messages are revised every three to four hours, or more frequently when appropriate.

When severe weather threatens, forecasters at the local National Weather Service office interrupt the broadcasts with storm warnings, either recorded or “live” as the situation demands.

The frequencies used for NOAA Weather Radio (National Oceanic and Atmospheric Administration) nationwide are 162.40, 162.475 or 162.55 megahertz.



NIGHTTIME DRIVING

- Make sure all running lights and signal lights are clean and in working order. Have your headlights periodically checked and adjusted.
- Use care when passing other vehicles. Your motor home is a longer vehicle than a car, and you may have a more difficult time knowing when to pull back into your lane. If possible, have another person in the coach help you watch while maneuvering your motor home in traffic.



MOUNTAIN DRIVING

Special techniques must be used when driving in mountainous or hilly country.

CLIMBING A HILL

The transmission will automatically downshift as needed to climb most hills. If the hill is long or very steep, however, you may need to manually shift to a lower gear to keep the transmission from repeatedly upshifting and downshifting. Select the lowest adequate gear range for the duration of the incline. See the Allison transmission manual in your Owners InfoCase for specific instructions.



CAUTION

Observe the engine temperature gauge more frequently than normal. If overheating occurs, pull off to the side of the road and allow the engine to thoroughly cool before refilling the radiator and restarting the engine.

DESCENDING A HILL

When going down a long grade, you may need to manually shift to a lower gear, rather than keeping your foot on the brake pedal. A lower gear will allow the engine to provide a degree of braking action. Holding your foot on the brake pedal for an extended period may cause brakes to overheat, causing you to lose control of the vehicle. See your chassis operating guide for more information. See also Jacobs Extarder Exhaust Braking System on page 2-4.

CAUTION

Observe the engine temperature gauge more frequently than normal. If overheating occurs, pull off to the side of the road and allow the engine to cool thoroughly before restarting the engine.

CAMPSITE SELECTION

Try to pick as level a spot as possible on which to park your motor home. Whether you nose into a parking site or back into it depends on personal preference and the location of the site's utility hook-ups. Remember that the utility connections on your motor home are on the left (driver) side of the vehicle.



LEVELING

(See "Coach Leveling Systems" on page 2-18).

Leveling the motor home is very important,

not only for your comfort but for appliances and plumbing as well. Some refrigerators are extremely sensitive to being off level. The ammonia vapor cooling system used in most RV refrigerators can "lock-up" and damage the refrigerator if it is not level. This is both inconvenient and costly. Also, water and holding tank level indicators may give false readings because water level is greater at one side of the tank than the other.

The refrigerator is installed level at the factory. So, if the refrigerator is level, the motor home is level. A small bubble-level sight is included in the refrigerator to help you determine refrigerator leveling.

NOTE: We do not recommend lifting any of the wheels off the ground for leveling. This could allow the coach to roll off the jacks, possibly resulting in damage to the vehicle.

Hydraulic Leveling System - Optional

See *Coach Leveling Systems* on page 2-18 for operating information.



EFFECTS OF PROLONGED OCCUPANCY

Your motor home was designed primarily for recreational use and short term occupancy. If you expect to occupy your coach for an extended period, be prepared to deal with condensation and humid conditions that may be encountered.

NOTE: Your coach is not designed or intended to be used as permanent housing. Using this product for long term occupancy or permanent housing may lead to premature deterioration of structure, interior finishes, fabrics, carpeting and drapes. Damage or deterioration due to long term occupancy may not be considered normal and, under the terms of the warranty, may constitute misuse, abuse, or neglect, and may therefore reduce your warranty protection.

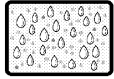

HUMIDITY AND CONDENSATION

Moisture condensing on the inside of windows is a visible indication that there is too much humidity inside the coach. Excessive moisture can cause water stains or mildew which can damage interior items such as upholstery and cabinets. When you recognize the signs of excessive moisture and condensation in your coach, you should take immediate action to minimize their affects. You can help reduce excessive moisture inside the motor home by taking the following steps:

Ventilate with outside air: Partially open one or more windows and a roof vent to circulate outside air through the coach. In cold weather, this ventilation may increase operation of the furnace, but will greatly reduce condensation inside the coach.

Minimize moisture released inside the coach: Run the range hood fan while cooking, and open a bath vent while bathing or showering to carry water vapor out of the coach. Avoid making steam from boiling water excessively or letting hot water run. Avoid bringing extra moisture into the coach by way of soaked clothing or snow on shoes. Do not hang-dry wet overcoats or clothing inside the coach.



(See also Safety Precautions, Section 1 of this manual.)



LP GAS SUPPLY

The LP gas system supplies fuel for the range, water heater, furnace and refrigerator (while in gas mode). When used and handled properly, this system is safe and economical and provides modern living conveniences wherever you travel.



SAFE USE OF THE LP GAS SYSTEM

The LP system is designed and built with strict adherence to both federal and recreational vehicle industry requirements for mobile LP gas equipment.

For your safety, there are many safety devices and backup systems installed, such as tank fill overflow valves, an interior LP gas detector/ alarm, and an interior carbon monoxide (CO) detector/alarm.

LP gas also contains an odor additive that you can smell if LP is present in the air.

Listed below are a few precautions to observe that will help you to use the LP gas system safely.

- Exercise caution at all times. Be familiar with the distinctive odor of LP gas. If a leak is suspected, turn off the supply valve immediately. Have the LP gas system checked by your dealer or a qualified LP gas service center.
- Do not tamper with the LP gas piping system, pressure regulator or gas appliances. Service and maintenance of LP gas system components should be performed only by your dealer or a qualified LP gas service center.
- Never attempt to connect natural gas to the LP gas system.
- Have the entire LP gas system inspected for possible leaks and missing or damaged parts

at each tank filling. Also inspect before and after each trip, and any time trouble is suspected.

- Turn the LP supply valve off when not using the LP gas system.
- Never use a wrench to tighten the tank supply valve. It is designed to close leak-tight by hand. If a wrench is required to completely close the valve, it is defective and must be replaced.
- Never allow the tank to be filled above the 80 percent level indicated by the flow of liquid gas out of the overflow valve or by the automatic stop-fill device.
- Be sure appliance and outside vents are open and free from obstruction when using the LP gas system.
- Never attach a lock or any device requiring a key to the LP tank compartment door. According to standards set for recreation vehicles, the LP supply valve must be readily accessible in an emergency.
- Exercise caution when drilling holes or attaching objects to the walls. Gas lines and electrical wiring could be seriously damaged and present an extreme safety hazard.

HOW LP GAS WORKS

LP (Liquefied Petroleum) gas is a true gas compressed into liquid form for easy transportation and storage. LP gas is available in two types - propane and butane. It is also called tank gas, bottle gas, or simply LP.

LP is used by appliances in vapor form only, but is stored in the tank as a liquid under very high pressure. As the liquid gas is released, it reverts back to a vapor and expands to many times its compressed volume.



SELECTING LP FUEL TYPES

We recommend using straight propane in your LP tank. Propane gas is commonly available at all LP gas outlets in the U.S. and Canada (According to the National LP Gas Association, LP gas outlets in the United States do not offer any other type of liquefied petroleum gas than propane to the general public.) Check local phone directory yellow pages for locations of local LP gas refilling stations or bulk dealerships.

NOTE: If you travel outside the U.S. with your motor home, you may find butane or propane/butane mixtures available in addition to propane. Because gas-burning RV appliances are designed to run on propane only, we recommend that you request straight propane only. Butane burns about 30 percent hotter than propane and can overheat some appliances, particularly refrigerators, and cause permanent damage. Other appliances designed to operate on propane can become sooted and lose efficiency by using butane fuel.

LP GAS OUTPUT

Each gallon of liquid LP gas contains approximately 92,000 BTU's of heat energy; or about 36.2 cubic feet of dry gas for cooking, heating, water heating and refrigeration.

LP gas tank capacities are often listed in pounds rather than gallons. A gallon of LP weighs 4.24 pounds. LP tanks can only be filled to 80% of their total capacity, so your 130-pound tank would actually hold 104 pounds, or about 24.5 gallons.

To find out how long a gallon of LP gas will last, you should determine the total BTU **input** on all your LP gas appliances in use. Let's say you have a furnace that has a 10,000 BTU **input** per hour of operation. A gallon of LP gas would last 9.2 hours of continuous operation (92,000 BTU's ÷ by 10,000 BTU's = 9.2). To estimate how long a gallon of LP gas lasts, try to determine what your total daily BTU input is, then divide into 92,000 to arrive at an approximate daily LP gas consumption.

LP TANK SYSTEM

The storage reservoir for the LP gas system is a horizontally mounted tank which is permanently attached to the vehicle frame. The tank is accessible only from the outside of the vehicle. The tank supply valve is located near the top center of the tank, next to the regulator. Before opening the supply valve, check to be sure all controls for gas appliances are in the "Off" or "Pilot Off" position. If this step is not performed, LP gas could accumulate inside the motor home creating a fire or explosion hazard.

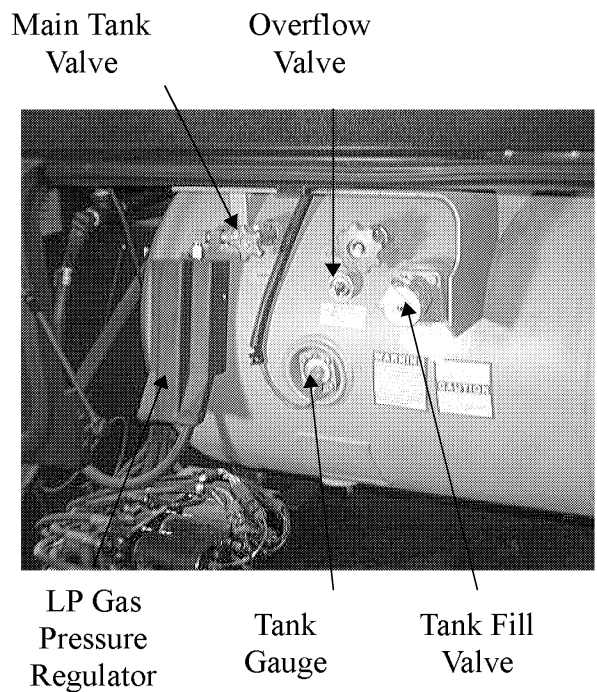

REFILLING LP TANK

There are many LP gas refueling stations located throughout the country. These stations are listed in the telephone directory Yellow Pages under "Gas - Liquefied Petroleum - Bottled and Bulk."

Since the LP tank is permanently mounted to the frame, the motor home must be driven to an LP supplier for filling. Do not attempt to remove the LP tank from the vehicle. The tank is equipped with a fill adapter with both internal and external threads which allows easy filling with any LP filling equipment. The tank is full when liquid LP gas appears at the overflow valve.

NOTE: The LP tank is equipped with an automatic 80% stop-fill device.



LP Gas Tank Capacity:

.....*31 gal. (39 gal. w.c.)

* LP Gas tank capacity shown is the usable “full” LP gas capacity, which is 80% of the tank manufacturer’s listed water capacity (w.c. shown in parenthesis). An LP tank must have at least 20% of tank volume free to allow for expansion and proper vaporization of the liquid fuel. The tank is also equipped with mandatory safety shut-off equipment that prevents filling above this level.

WARNING

Make sure the filling attendant uses the 80% overflow valve when filling the tank. A tank should never be filled above 80% level to allow for vaporization and liquid expansion.

Do not place LP gas containers inside the vehicle. LP gas containers are equipped with safety devices which relieve excessive pressure by discharging gas to the atmosphere.

Do not place LP gas containers, gasoline, or other flammable liquids inside the vehicle. Fire or explosion may result

AIR IN THE LP GAS TANK

If your LP gas appliances do not stay lit or require frequent adjustment, even though you know the LP tank contains sufficient fuel, the problem may be air in the LP gas tank. Air in the tank mixes with the LP gas vapors causing them to burn poorly. This condition could linger for weeks if the air is not purged from the tank. Most LP gas dealers have equipment for purging air from LP gas tanks and will purge before refilling the tank.

TRAVEL WITH LP GAS

It is illegal for vehicles equipped with LP tanks to travel on certain roadways or through certain tunnels in the U.S. To avoid inconvenience, check state regulations concerning flammable gas transportation.

WARNING

Do not alter or remove LP tank gauge at any time.

WARNING

DO NOT FILL CONTAINER TO MORE THAN 80 PERCENT OF CAPACITY. Make sure the motor home is level when filling. It is possible to accidentally overfill the tank if the vehicle is unlevel, with the fill valve on the uphill side. Overfilling the LP gas tank can result in uncontrolled gas flow, which can cause fire or explosion. A properly filled container will contain approximately 80 percent of its volume as liquid LP gas.

All pilot lights must be extinguished and supply valve closed before refilling LP gas tanks or vehicle fuel tanks.

Do not smoke or expose an open flame while near an LP refueling area. LP gas is heavier-than-air and extremely flammable.

Never use an open flame to test for LP gas leaks.

Replace all protective covers and caps on LP system before filling.

Never fill the LP tank with engine or generator running.



REGULATOR

The pressure regulator is protected from the elements by a plastic cover which should be left in place at all times. Only your dealer or a qualified LP gas service should remove the regulator cover for adjustments.

WARNING

Inspect the pressure regulator vent hole periodically for blockage. If any obstruction is apparent, have the regulator serviced by your dealer or a qualified LP gas service center.

LP gas regulators are installed with the diaphragm vent facing downward. Make sure that the regulator vent always faces downward to minimize vent obstruction which could result in excessive pressure, causing a fire or explosion.

Regulator freeze-ups are caused by the presence of moisture in fuel. This moisture will pass through the cylinder valve and into the regulator where it can freeze. Fuel producers, tank and bottle manufacturers and LP gas dealers take every precaution to reduce moisture, but sometimes only a fraction of an ounce entering the tank can cause problems. To help avoid the possibility of freeze-up, always keep tank control valve closed when not in use, even when tank is empty, to prevent moisture from collecting on the inside.

If regulator freeze-up should occur, you may attempt to thaw the regulator using a light bulb. **DO NOT USE AN OPEN FLAME OR HEAT LAMP.**

Be sure vent hole is not blocked

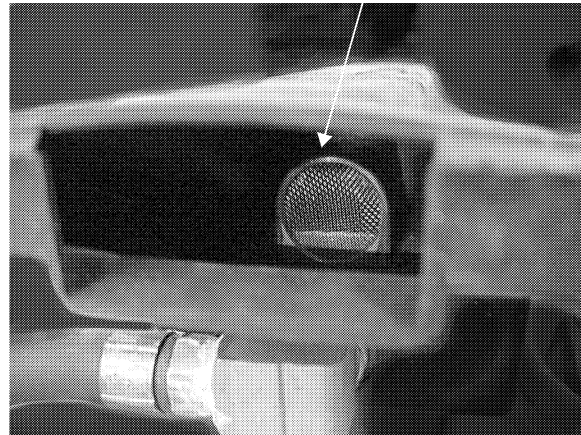

If moisture begins to cause problems, have your LP gas dealer inject a small amount of dry methyl alcohol in your tank (approximately one ounce to 20 pounds or one pint to 100 gallons) to help guard against regulator freeze-ups.

In very cold weather when a large volume of gas is being used for heating, it is possible to experience a loss of gas pressure. At first, this problem may appear to be caused by a regulator freeze-up, but is actually caused by failure of the liquid gas to vaporize as fast as it is needed. As the temperature becomes colder, it is increasingly harder for the liquid LP gas to vaporize. At the same time, the demand for LP to produce heat increases to the point where the system cannot maintain production.

The only solution to this problem is to reduce the consumption of gas where possible. Adjusting the temperature on the gas/electric refrigerator may be a first step. Using less hot water will help as well.



LP GAS LEAKS

The following label has been placed in the vehicle near the range area. If you smell gas within the vehicle, quickly and carefully perform the procedures listed.



IF YOU SMELL GAS

1. Extinguish any open flames, pilot lights and all smoking materials.
2. Do not touch electrical switches.
3. Shut off the gas supply at the tank valve(s) or gas supply connection.
4. Open doors and other ventilating openings.
5. Leave the area until odor clears.
6. Have the gas system checked and leakage source corrected before using again.

WARNING

Never use an open flame to test for gas leaks. When testing for gas line leaks with a soapy water solution, DO NOT use a detergent containing ammonia or chlorine. These substances may generate a chemical reaction causing corrosion to gas lines, resulting in dangerous leak conditions.

LP GAS ALARM - See page 1-2.



WINTER USE OF LP GAS

Due to vaporization characteristics of LP gas, it is important that the winter camper knows how to most efficiently use the LP system. The vaporization rate of LP gas decreases in a direct relationship to a decrease in temperature. Propane will convert to a usable gas at temperatures down to -44°F. For this reason, propane is a popular heating fuel in cold climates.

The greater the amount of liquid gas in the tank (up to 80% level) the greater the amount of LP gas vapor generated. The following is an example of the number of BTU's available from an 84-pound tank at 0° F at three levels. As you can see, the number of BTU's decreases as the tank is emptied. Nearly twice as many BTU's are available from a full tank than one that is one-fourth full.

BTU's Available at 0° F.

<u>Tank Level</u>	<u>BTU's</u>
80%	64,000
50%	50,400
20%	33,000

The following LP Gas Vaporization and Temperature Relationship chart typifies the LP gas loss with a decrease in temperature. The percentage figures are the increase or decrease of vapor that would be available at 0°F. These figures apply to any size LP gas tanks.

<u>Temperature</u>	<u>Percentage of BTU's Available at 0° F.</u>
20° F.	200%
10° F.	150%
0° F.	100%
-5° F.	75%
-10° F.	50%
-15° F.	25%
-20° F.	12 1/2%
-44° F.	Propane will not vaporize

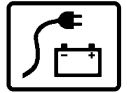

(See also Safety Precautions, Section 1 of this manual.)

Your coach is equipped with an electrical system consisting of two separate voltages; a 12-volt DC system and a 110-volt AC system. The 12-volt system consists of two internal power sources, while the 110-volt system is operated from an outside power source, or from the optional 110-volt generator or 110-volt inverter system.

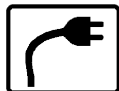

110-VOLT AC SYSTEM

The 110-volt system operates from an outside 110-volt utility service such as those at campgrounds, or from the 110-volt generator or 110-volt inverter system. When the power cord is connected to an outside power source, or when the generator is in operation, the power converter automatically changes a portion of the 110-volt current to 12-volt DC current. All equipment in the motor home that is normally powered by the auxiliary battery is then powered through the converter.

In addition, the following equipment is entirely dependent on 110-volt current: central air conditioner, refrigerator (when placed in 110-volt mode), microwave oven, ice maker, vacuum cleaner and other 110-volt electrical equipment used at convenience outlets.



EXTERNAL POWER CORD (Shoreline)

The external utility power cord (commonly referred to as a “shoreline”) is stored in the water center/shoreline compartment on the left (driver’s) side of the coach.



Shoreline Compartment

WARNING

Do not connect the external power cord to any receptacle **until** you have contacted the owner and/or attendant of the premises to verify proper polarity and grounding.

It is the responsibility of the owner of the electrical receptacle to ensure that the receptacle is properly wired and grounded.

Reverse polarity and improper grounding of the vehicle can cause personal injury or death

The power cord is designed to ground the electrical system through the receptacle. It is also designed to carry the amperage output of most campground outlets. If the electrical receptacle to be used is designed to mate with the prongs of the power cord plug, the electrical connection can be expected to carry rated load.



CONNECTING THE SHORELINE

To connect to an external source, remove the cord from the storage compartment and plug it into a suitable 50-amp power receptacle to provide external power to the coach and converter/charger system.

NOTE: Some parks do not have 50-amp service available, so you will need to connect to a standard 30-amp service pole using an adaptor.

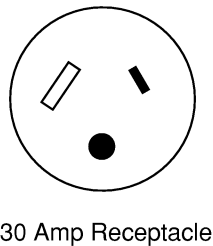
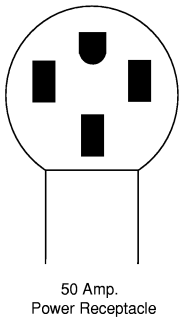

A rotating hatch in the compartment floor lets you route the shoreline cord through a passage in the bottom of the compartment so you can shut the compartment door while the shoreline is connected.

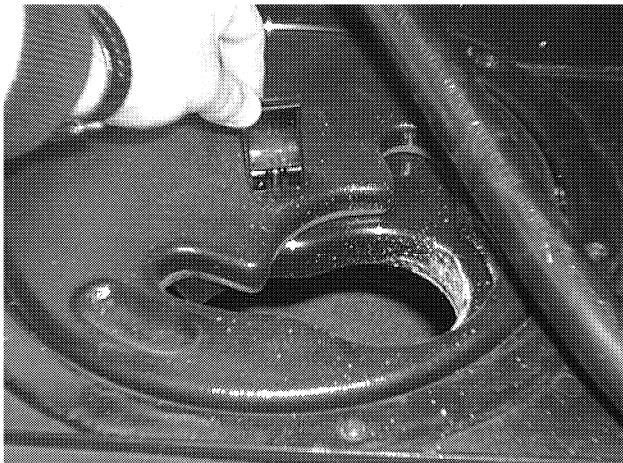

1. Flip the retainer in the center of the cover straight up.

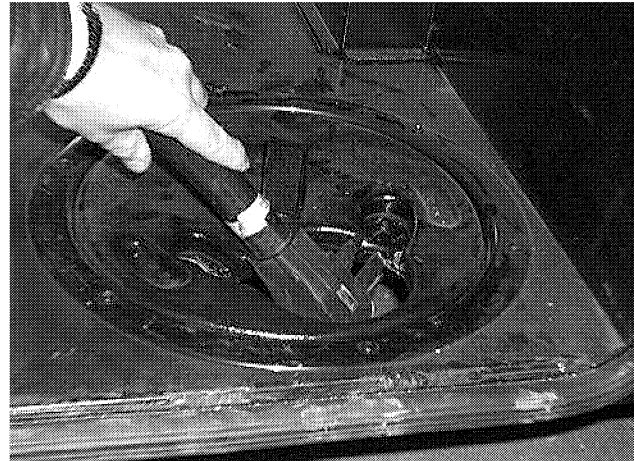

2. Rotate the cover to the largest hole to pass the cord end through.

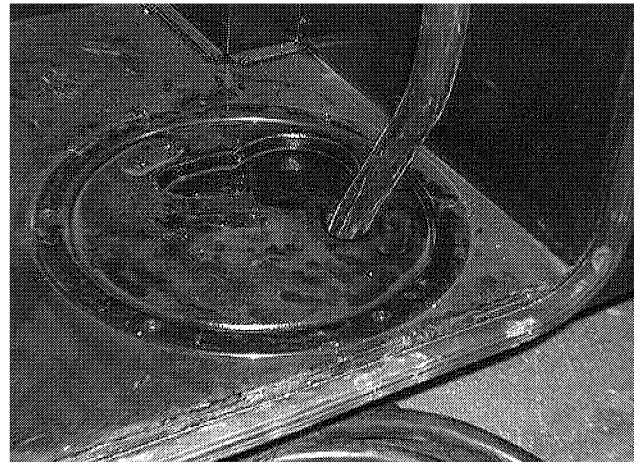

3. Then rotate to the smaller opening to enclose the cord.

WARNING

Do not plug the power cord into an outlet which is not grounded, or adapt the plug to connect to a receptacle for which it is not designed.

Be sure that all four prongs of the supply cord are properly plugged into the receptacle.

Do not connect the power cord to an extension cord.

Park Fuses or Breakers

Most campgrounds are equipped with a fuse or circuit breaker at the receptacle. This protects the park's wiring, as well as the power cord on your vehicle, from electrical damage. If electrical power fails, contact the park attendants and have them check the fuse or breaker for your supply receptacle.

After disconnecting the power cord, neatly replace it in the storage compartment.



POWERLINE ENERGY MANAGEMENT SYSTEM (EMS)

The energy management system (EMS) monitors the electrical usage of the appliances and equipment in the coach and distributes the electrical loads to avoid nuisance tripping of the shoreline circuit breaker. This system works together with the energy efficient central air conditioner to allow you to run both compressor units at the same time on a 30-amp shoreline connection.



EMS Display on OnePlace Monitor Panel

Please read your PowerLine Energy Management System Owners Guide for important information on running both air conditioner compressor units at the same time. This guide will also explain how this system operates under several conditions, whether 20-amp, 30-amp or 50-amp connections.

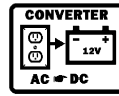

POWER CONVERTER SYSTEM

The power converter changes 110-volt AC current from the auxiliary generator or the shoreline into 12-volt DC current for use by 12-volt equipment in the motor home.

Certain circuits, however, remain unchanged for use by items which require 110-volt current, such as the air conditioner(s), the refrigerator in AC mode, the microwave oven, etc.

Current drawn from the coach batteries passes through the power center unchanged, although it is routed through a series of protective circuit breakers.

CAUTION

Do not store items too closely around the inverter unit in the storage compartment. The inverter generates heat while operating and needs unrestricted airflow for proper cooling.

12-Volt House Circuit Breakers

The 12-volt house breaker panel contains pop-out breakers; push in to reset. The breakers are clearly labeled for the circuits which they protect. The breaker panel is located behind a small door below the refrigerator.



**House 12V Breakers
(below refrigerator)**

**Typical view of breaker panel. Actual fuse or breaker labels may vary according to appliance and equipment options. Fuses and breakers are labeled on panel.*

110-VOLT CIRCUIT BREAKERS

The breaker panel protects all 110-volt components in the motor home from either an overload on the circuit or a short in the wiring or component itself. When an overload or short develops, the breaker will open preventing any further flow of electricity and, therefore, damage to the system.

Shut off the equipment (example: air conditioner) and allow a brief cooling period. Then reset the breaker by moving the switch to “Off” and back to “On”. If the breaker continually trips and no equipment is running, have the system checked for a short in the wiring or the appliances.

The 110-volt circuit breaker panel is located behind the cabinet door at the foot of the bed.

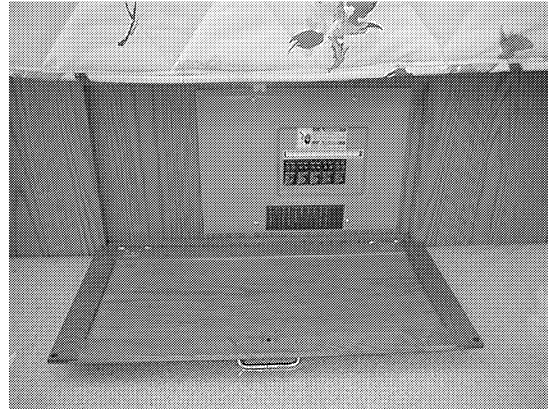

**110-Volt House Circuit Breakers
(at foot of bed)**

CHARGING SECTION

The house batteries are automatically charged while 110-volt external power is connected. The charger will automatically “sense” the condition of the RV battery. If it is below “full charge”, the Charging Section will start charging the battery.

If the house batteries have been extremely discharged, they will accept charge at a relatively high amperage rate. If they are only slightly discharged, they will charge at a lower amperage rate. The rate of charge will decrease as the batteries reach “full charge”, then will remain “trickle” charging at a very low amperage rate. If your storage battery does not charge as described above, it is possible the battery is defective.

NOTE: We do not recommend leaving the shore-line plugged in continuously during storage periods because the batteries can lose electrolytic fluids and become damaged from continuous charging without periodic use. We recommend following regular battery inspection and maintenance, especially in cold weather. See “Battery Storage & Maintenance” on page 6-11 this section.

THERMAL OVERLOAD PROTECTOR

A thermal overload protector will shut down the converter if it becomes overheated. This can result from operating above its maximum limit

for an extended period of time or by obstruction of ventilation to unit.

NOTE: 12-volt lights and motors will automatically draw from battery power in this event.

The thermal breaker will reset itself after a cool-down period, and the lights and motors will resume operating from the converter. If the overload trips again shortly after reset, take immediate steps to correct the cause of overheating. A portion of house 12-volt load (lights or motors or both) should be turned off to reduce total load. Also, inspect the inverter unit to make sure ventilation is not obstructed.

CAUTION

Do not store items too closely around the inverter unit in the storage compartment. The inverter generates heat while operating and needs unrestricted airflow for proper cooling.

110-VOLT RECEPTACLES (OUTLETS)

A number of standard AC electrical outlets are provided throughout the coach for connecting small appliances such as televisions, radios, toasters, etc. An outdoor outlet is also located on the outside of the coach near the entrance door.



GROUND FAULT CIRCUIT INTERRUPTER

Exterior, bath and galley outlets are connected to a GFCI (Ground Fault Circuit Interrupter), which is an extremely sensitive circuit breaker that will help to protect against severe electrical shock if a ground fault develops. If such a condition occurs, the GFCI will break the circuit by turning off the power to the protected outlets. If this happens, unplug all the appliances on that circuit and press the reset button on the GFCI equipped outlet.

If the GFCI keeps tripping, have the electrical system checked and repaired if necessary before using again.

The GFCI outlets are located in the bath and galley areas of the vehicle.



Ground Fault Circuit Interrupter (GFCI)

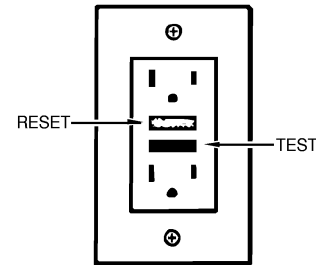

WARNING

The GFCI will not completely eliminate electrical shock. Small children and persons with heart conditions or other disabilities which make them especially sensitive to electrical shock may still be injured by a 110-volt receptacles even though protected by a Ground Fault interrupter.

NOTE: In compliance with CSA electrical codes, the appliance outlet in Canadian equipped coaches is not connected to a GFCI protected circuit.

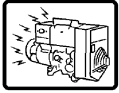

AUXILIARY 110-VOLT GENERATOR

Consult the generator manufacturer's information provided in your Owner InfoCase for instructions on operation, troubleshooting and maintenance.

This coach may be equipped with one of several models of generators. Consult the generator owner's manual in your InfoCase for specific instructions on starting, stopping your generator.

NOTE: Diesel powered generators draw their fuel from the main chassis fuel tank. LP gas powered generators draw fuel from the LP gas tank.

After extensive generator use, you may notice decreased levels in the affected fuel tank.

WARNING

Careless handling of the generator and electrical components can be fatal.

Never touch electrical leads or appliances when your hands are wet, or when standing in water or on wet ground.

Do not attempt to repair the generator yourself. Service should be performed by an authorized service center.

Automatic Power Transfer Switch

Your coach electrical system is equipped with an automatic generator power transfer switch. The transfer switch is normally in an "off" mode when no AC current is required.

When the generator is started, the transfer unit will switch the power feed to the generator after 20 seconds. The twenty-second delay is to allow the generator to start easily without an electrical load.

Generator Power Switches: For your convenience we have mounted generator power

switches in three locations throughout the coach; in addition to the switch on the generator itself:

- Instrument Panel
- Systems Monitor Panel (One Place)

Basic Generator Operation:

For your convenience, generator switches are located on the dash, on the range hood, and on a nightstand cabinet in the bedroom as well as on the genset unit itself in the generator compartment. The generator starter circuit does not rely on the automotive battery, so the switch will operate whether the ignition switch is on or off.

- See generator manufacturer's operating information for specific instructions.
- Reduce all electrical loads. (Shut off lights, fans, appliances, etc.)
- If the generator has not been run for two weeks or more, you may need to prime the fuel system before attempting to start.
- Press the generator starter switch on and hold until generator engine is running, then release.

NOTE: Diesel generators may require glow plug pre-heating before starter will engage. See diesel generator manual for details.

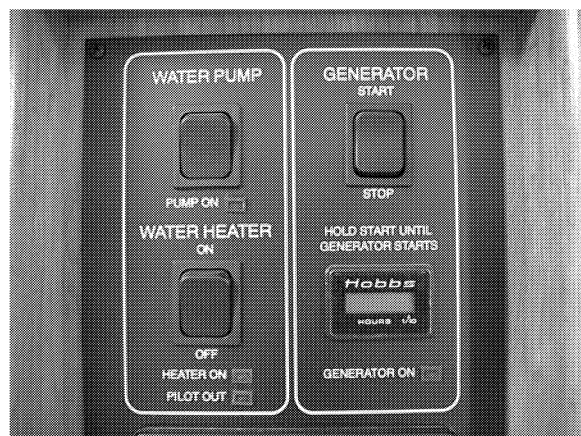

Generator Switch and Hourmeter

- Let the generator engine stabilize and run smoothly before turning appliances or electrical equipment on.

- Do not overload generator by turning too many items on. See load chart for estimation of typical RV loads. Refer to the output specifications of your generator in the generator manufacturer's manual. Then see the following electrical load chart to estimate your typical loads.

NOTE: While the generator is running it is normal for the hourmeter to make a periodic "ticking" sound.

Stopping

- Before shutting generator down, turn off electrical loads and let engine run at no-load for a few minutes to cool down.
- Press the generator switch Off and hold until the generator engine comes to a complete stop.

CAUTION

Continuous generator overloading can cause high operating temperatures that can damage the generator windings. Keep the electrical loads within the generator wattage rating.

Approximate Power Requirements of Common Appliances	
Appliance or Tool	Approximate Power Consumption (Watts/Amps)
Vacuum cleaner	200-500W/1.7-4.3A
Coffee Maker	550-700W/4.8-6.1A
Hair dryer	800-1500W/7.0-13.0A
Electric clothes iron	500-1200W/4.3-10.4A
Electric blanket	50-200W/0.4-1.7A
Television	80-100W/0.7A
Electric drill	250-750W/2.2-6.5A
Air conditioner	1400-2000W/13-19A
Microwave Oven	700-1500W/6.0-13.0A

Generator Hourmeter

This meter is located on the monitor panel. It registers the total number of hours that the generator has been operated. Refer to the hourmeter to determine when periodic maintenance is due and to record services which have been performed.

OPERATION WARNINGS AND CAUTIONS

WARNING

The exhaust of all internal combustion engines contains carbon monoxide (CO). This poisonous gas is colorless, odorless, tasteless, and lighter than air. The exhaust systems of both your motor home engine and your generator engine have been installed with your safety in mind. However, certain precautions must be taken when using them to protect yourself from conditions beyond the control of the manufacturer.

- Do not** simultaneously operate the generator engine and a ventilator which could draw exhaust gases into the vehicle.
- Do not** open windows or ventilators on the end or side of the vehicle where exhaust pipe of the generator is located.
- Park the vehicle** so that the wind will carry the exhaust away from the vehicle. Also, note the position of other vehicles to be sure their exhaust will not enter your vehicle.
- Do not** operate the generator engine when parked if vegetation, snow, buildings, vehicles, or any other object can deflect the exhaust under or into the vehicle.

Check auxiliary generator oil level frequently during periods of use. Refer to the generator manufacturer's information in your Owners InfoCase for specific recommendations.

WARNING

Never check generator oil level while generator engine is running.



12-VOLT DC SYSTEM

The DC voltage system consists of the automotive batteries and the 12-volt coach auxiliary batteries.

12-VOLT FUSES AND CIRCUIT BREAKERS

All 12-volt circuits and equipment in the coach area of the motor home are protected by a circuit breaker panel. When a circuit is overloaded or a short develops in any part of the system, a breaker will shut down that circuit. If this happens, turn off all affected lights or appliances and reset the breaker.

A label on the panel states the amperage rating and circuit protected for each breaker.

The House 12-Volt Breaker Panel is located behind the small cabinet door below the refrigerator.



House 12-Volt Circuit Breaker Panel

*Typical view of breaker panel. Actual fuse or breaker labels may vary according to appliance and equipment options. Fuses and breakers are labeled on panel.

12-VOLT CHASSIS CIRCUIT BREAKERS

The 12-volt automotive and coach circuit breakers are located on a panel on the firewall in the engine compartment. See page 9-7 for further information.

Auto Chassis 12-Volt Breaker Panel



“Hood” Compartment

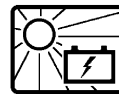

SOLAR CHARGER PANEL

The 10-watt roof-mounted solar charger panel uses the sun to help keep your batteries charged. A charge indicator light is provided on the One Place panel to show you when the solar panel is actively charging the house batteries.

The red light will glow when the solar panel is charging the coach batteries. The greater the rate of charge, the brighter the light. When the batteries reach full charge, the light will gradually dim, then darken.

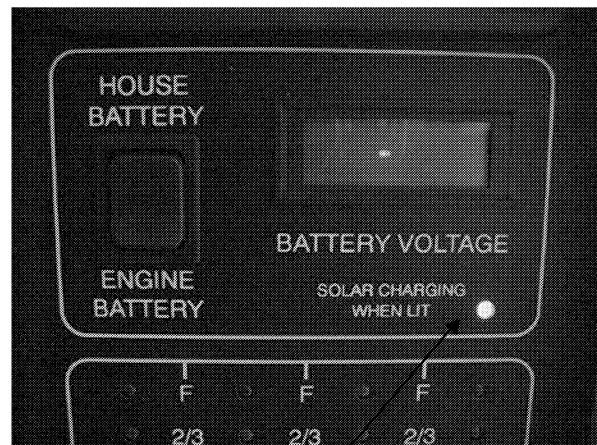

Solar Charging Indicator



NOTE: The solar battery charger is not intended to make the coach battery system “maintenance free.” The solar panel will not completely compensate for continuous low amperage draw from components such as the LP gas leak detector, the clock in the dash radio and the radio station memory circuitry, for example.

Although the solar panel system can help to extend battery life, the coach shoreline should be plugged in routinely to “top off” the batteries. We also recommend following regular battery inspection and maintenance, especially in cold weather.

See “Battery Maintenance” on page 6-10 this section.

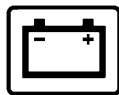

BATTERY INFORMATION

CHASSIS (Starting) BATTERY

The chassis batteries are used solely to operate the engine starter and all automotive accessories and controls found on the instrument panel. This includes the horn, speed control, all exterior lights, radio, windshield wipers, rear auto heater fan, etc.

Chassis Battery Storage: The chassis (starting) batteries are located in a slide-out tray in the battery compartment on the right side of the coach. (See Exterior Features Identification on page 0-4 of the Introduction section.)

Lift the retainer catches that hold the battery tray and slide it outward for service.

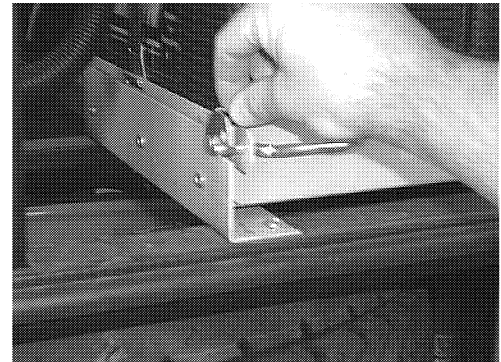

Lift Battery Tray Retainer Latches

HOUSE BATTERIES

The house batteries supply current to all 12-volt equipment located in the living area of the coach. This includes interior lights, range exhaust fan, furnace fan, water pump, water level and holding tank gauges, 110-volt generator starting, refrigerator and bath roof vent fan. The house battery may also be used to start the engine if the automotive battery is dead. Refer to “Aux. Start Switch.”

The house batteries are automatically charged by the engine alternator while the engine is running.

House Battery Storage

The batteries are also located in the battery compartment on the left side of the coach. See “Chassis Battery Storage” for access instructions.



BATTERY STORAGE AND MAINTENANCE

Lead -acid type batteries are electro-chemical devices for storing and releasing electrical charge. As such, they are simply an electrical reservoir, not an electrical source. As soon as energy is removed from the battery, it should be replaced by the engine alternator or the RV converter system.

If a battery sits unused for 30 days or more, especially during warm weather, it can develop a deposit of sulfate crystals on the metal plates inside the battery. This condition is called sulfation



or sulfating, and prevents the battery from either releasing or accepting a charge. If this condition occurs, the battery must be replaced.

If a battery does not contain at least 80% charge during freezing temperatures, the electrolyte can freeze and crack the battery case.

The two best defenses against either sulfating or insufficient charge are:

1. To disconnect the battery cables to avoid any “parasitic” discharge, and
2. to check the battery and recharge as necessary at least once a month during long periods of storage.

A further precaution is to remove the battery from the vehicle and store it in a cool location on a wooden or rubber pad, checking charge periodically to avoid discharge or sulfating.

To ensure that the battery will always accept and hold a charge, follow these simple maintenance practices.

- Make sure the batteries always remain securely clamped in the battery tray.
- Make sure battery cable clamps are tight on the terminal posts and are free of corrosion.
- Neutralize corrosion buildup or acid film on top of battery by washing with a baking soda/water solution. Rinse with clear water.

NOTE: Make sure vent caps are on securely to prevent baking soda solution from entering the battery and contaminating the electrolyte fluid.

WARNING

Before removing any battery cables or battery, make sure all 12-volt equipment in the motor home is off and the power cord has been disconnected.

Replace any damaged cables at once. Always remove jewelry and wear protective clothing and eye covering when checking or handling batteries.

- Clean and tighten battery terminals and have

the specific gravity checked at least once a year.

- Every two months, or more often in hot weather, check the battery fluid level. Fill to approximately 3/8 inch above the plates. **DO NOT OVERFILL.** If fluid is added during freezing weather, the motor home should be driven several miles to mix water and electrolyte to prevent freezing.
- Fluid level check may be omitted if equipped with maintenance-free batteries.

WARNING

To prevent wiring damage, it is essential when replacing the cables on the battery, or when using a “booster” battery, that the positive post and the positive cable be attached and the negative post and negative cable be attached. The posts are marked (+) plus and (-) minus. If a “fast charger” is used while battery is in the motor home, disconnect both battery cables before connecting the charger. Never attempt to charge or boost a frozen battery.

HOUSE BATTERY REPLACEMENT

This coach is equipped with deep-cycle type batteries designed for recreational vehicle use. They will provide longer lasting power than standard automotive batteries, and will withstand the frequent drain-and-recharge cycles that occur under the demanding conditions of RV usage.

Replacement batteries should be deep-cycle type with equivalent specifications to avoid loss of electrical storage capacity.

- Deep-cycle
- 130 Amp Hr.
- 225 minutes reserve capacity
- 665 CCA (cold cranking amps)

BATTERY CONDITION METER

See related item under “Monitor Panel” in section 8, Appliances.



AUX. START SWITCH

See section 2, Driving Your Motor Home for information on Aux. Start Switch.

TRAILER WIRING CONNECTOR

Your coach is pre-wired for trailer or car towing lights with a 6-pin socket on the rear bumper. The connector plug is supplied in the coach parts package provided to you by your dealer when you took delivery of the vehicle.

The diagram below shows proper connection of trailer or tow vehicle wiring to the coach light system. To access the wire connections inside the plug, remove the small screw near the end of the plug and slide the contact assembly out of the barrel.

- TM = Tail lights
- GD = Ground
- LT = Left Turn
- RT = Right Turn
- S = Brake lights
- A = Backup lights

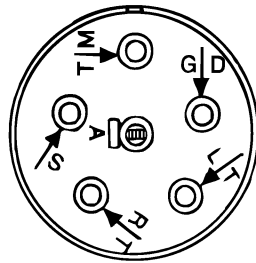



FRESH WATER SYSTEM



Fresh Water Tank..... 86 gal.

The fresh water system provides water to the galley sink, shower, bathroom lavatory, toilet and water heater. Water may be supplied by either of two sources:

- a water tank located within the motor home, or
- any external water source to which the motor home may be connected, known as “city water”.

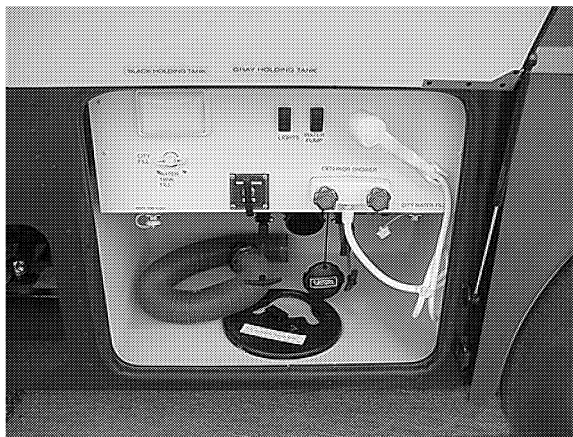
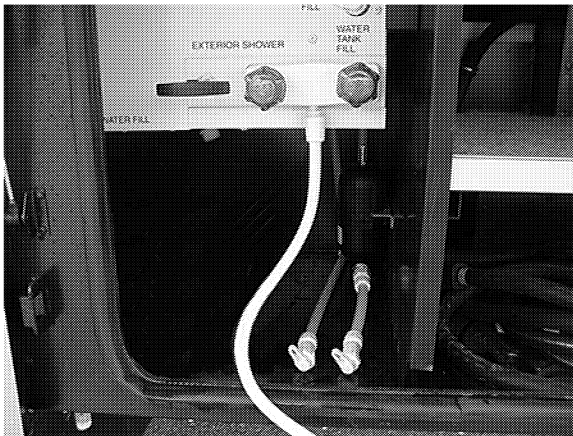

Water Center - Model 32TD

FRESH WATER TANK FILLING

PROCEDURES:

Always fill the fresh water tank at an approved potable water filling facility or a known purified drinking water source.

To Pressure Fill Water Tank from City Water Connection:

1. Attach a hose from a city water faucet to the city water connector in the water center on the left (driver) side of your coach.
2. Open the Gravity Fill door to provide adequate air venting and avoid pressure buildup.
3. Turn the tank fill valve to the WATER TANK FILL position.

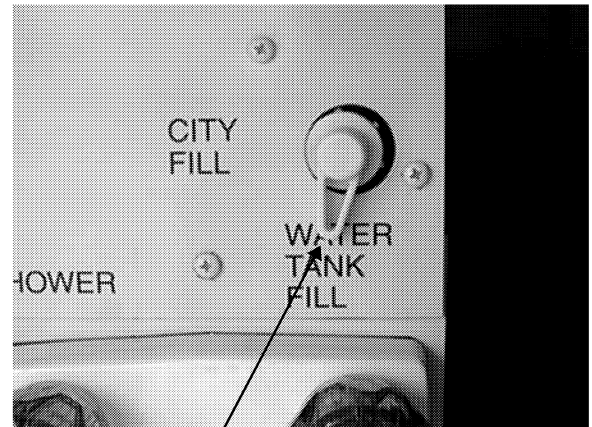

Turn tank fill valve to FILL position.

4. Tank is full when water begins to flow from the overflow vent tube beneath the coach.

NOTE: Because city water pressure varies from location to location, we recommend using an in-line water pressure regulator to prevent damage to any components, connections and seals in your fresh water system.

A water pressure regulator may be obtained from any well stocked RV dealership retail center and some retail discount centers. These devices simply



connect in-line between the supply hose and the city water input on the coach.

*We recommend a regulator that controls water pressure to **40 psi maximum**.*

NOTE: *Always keep the tank fill valve closed unless you are filling the tank. If this valve is open while using the city water, the water will keep flowing into the tank and out the gravity fill tube.*



WATER PUMP

When your coach is not connected to a city water supply, water is supplied from the fresh water tank by a water system demand pump. A demand pump is designed to run only when a faucet is turned on and shut off soon after the faucet is turned off. When you turn a faucet on, the pump will begin to run, and it will continue to run as long as the faucet is open.

The pump is self-priming and will run briefly to build up line pressure when the Water Pump Switch is first turned on. See “Initial Water Line Priming” for instructions on using the water system for the first time after a storage period or if the tank and water lines have been drained.

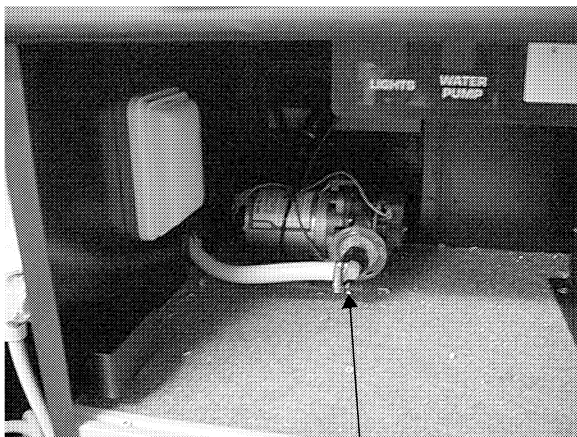

Water Pump

Pump Strainer Filter

The pump is equipped with a cleanable strainer filter to capture any possible tank borne particles that could damage pump components.

NOTE: *We recommend that you check and clean this filter after each tankful of water during the first few uses of the water pump system. Thereafter, remember to check it at least yearly, such as during winterization procedures.*

Press cover in firmly and twist counter-clockwise to remove

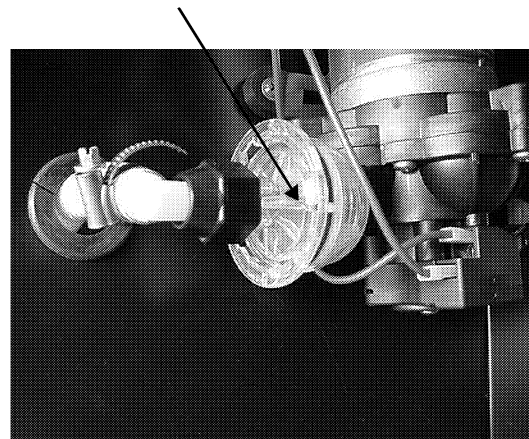

Water Pump Strainer

To Clean Pump Strainer

- Push the flat inlet cover in towards the rounded bowl section and twist counter-clockwise about 1/4 turn to disengage from locking tabs.
- Remove the cap, then pull the strainer out of the bowl. Tap out any particles and rinse clean.
- Insert the strainer back into the bowl, then twist the cap back into the bowl assembly to close.

Water Pump Switch

Your coach is equipped with water pump switches in three convenient locations:

- on the monitor panel (see section 8)
- in the bathroom
- in the utility service compartment on the outside of the coach



While any pump switch is in the “ON” position, the pump will automatically supply water pressure as it is needed. It is recommended that the pump switch be turned off whenever you are away from the vehicle or not using the water system. A slow leak in a faucet could drain the water system and discharge the coach battery.

NOTE: The water pump does not need to be switched on while the coach is connected to a city water hookup. See “External Water Supply” on the following page.

Initial Water Line Priming

1. Make sure that all water drain valves are closed, including water heater valve. (Refer to Section 10.)
2. Turn water pump switch to “OFF” position.
3. Fill water tank.
4. Open all faucets, hot and cold.
5. Turn on pump switch.
6. Close each faucet as it begins to deliver a steady stream of water (close cold water first). Leave hot water faucets on until they also deliver a steady stream of water. This will ensure that the water heater is filled with water.
7. Check to be sure pump stops soon after all faucets have been closed.
8. Pump is now ready for automatic operation. Pump will start when a faucet is opened and stop when the faucet is closed.

ACCUMULATOR TANK

A pressurized accumulator tank is installed in the water line directly upstream from the water pump located in the water pump compartment on the left side of the coach.

The accumulator tank holds a small amount of water under pressure of 20 psi to reduce water line pulsation noise and pressure variations when using the water pump system. This also contributes to longer pump life, less pump cycling, and less amperage draw by the water pump from the coach batteries.

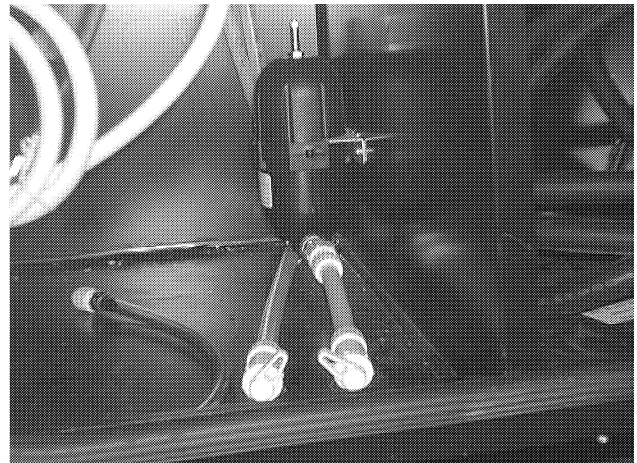

Accumulator Tank

*NOTE: The accumulator tank has a precharge pressure which must be **checked monthly** and maintained at **20 psi** for the system to work properly.*

Adjusting Precharge Pressure

A tire-type valve stem is provided on the end or top of the accumulator tank to check or add air pressure. (Note arrow in above photo.)

When adding air, do not exceed 20 psi tank precharge pressure because you may risk rupturing the pressure bladder inside the accumulator tank.

Because of the relatively small capacity of the bladder, check pressure with a standard tire pressure gauge before adding air, then if necessary, add air in small bursts, checking pressure between each burst until 20 psi is attained.

Overfilling will also push the bladder too far and reduce the volume of water held in the accumulator tank, making the system inefficient.

The precharge valve stem cap **must be tight** to prevent pressure leak-down.

Further Information

See manufacturer’s information supplied for your Owners InfoCase for complete maintenance instructions and precautions.



INSTRUCTIONS FOR DISINFECTION OF FRESH WATER SYSTEMS ON RECREATION VEHICLES

(As approved by the U.S. Public Health Service)

To assure complete disinfection of your fresh water system, it is recommended that the following procedure be followed on a new system, one that has not been used for a period of time, or one that may have become contaminated. This procedure is also recommended before long periods of storage such as over winter.

1. Prepare a chlorine solution using 1 gallon of water and 1/4 cup of household bleach (sodium hypochlorite solution). With tank empty, pour chlorine solution into the tank. Use 1 gallon solution for each 15 gallons of tank capacity. This procedure will result in a residual chlorine concentration of 50 ppm in the water system. If a 100 ppm concentration is required as discussed in item 3, use 1/2 cup of household bleach with 1 gallon of water to prepare the chlorine solution. One gallon of the solution should be used for each 15 gallons of tank capacity.
2. Complete filling of tank with fresh water. Open each faucet and run the water until a distinct odor of chlorine can be detected in the water discharged. Do not forget the hot water taps.
3. Allow the system to stand at least 4 hours when disinfecting with 50 ppm residual chlorine. If a shorter time period is desired, then a 100 ppm chlorine concentration should be permitted to stand in the system for at least 1 hour.
4. Drain and flush with fresh water.

WARNING

Chlorine is poisonous - recap bottle and clean utensils after use.

Never use automotive type antifreeze in your potable water system as it is poisonous.



EXTERNAL WATER SUPPLY ("City Water")

To connect to an external source:

1. Turn the demand pump switch to off.
2. Attach a hose from the external water source to the city water connection in the water center compartment on the left side of your vehicle.

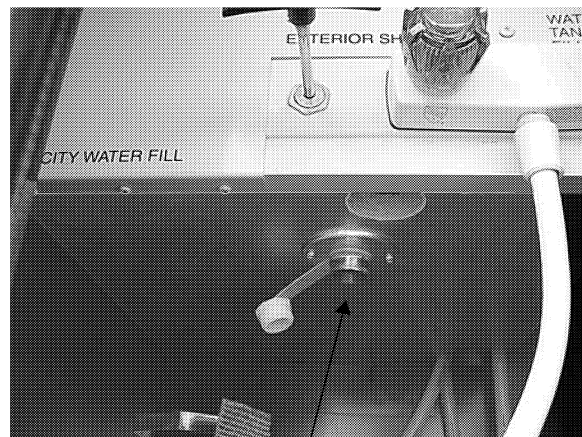

City Water
Connector

3. Turn water tank fill valve to CITY FILL position.



4. Turn on the external water source.

When connected to an outside source of water, the water bypasses the demand pump and storage tank and supplies pressure directly to



individual faucets and toilet. A check valve built into the pump prevents water from entering the pump and filling the storage tank.

To disconnect from the external source:

1. Turn the external source off.
2. Open a faucet inside the vehicle to relieve line pressure.
3. Disconnect the hose from the vehicle and replace the cap on the connection.

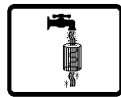

**WATER PURIFIER
(FILTER) SYSTEM**

The water purifier system uses a flow-through activated carbon filter that removes chlorine and other impurities, resulting in clean, taste-free and odorless drinking water.



Water Filter Assembly -
Below Galley Sink

Replacing the water filter cartridge:

Replace the filter cartridge when water flow from the purifier faucet is too slow for convenience.

- Place a container beneath the filter to catch any remaining water during removal.
- Raise the valve handle near the top of the filter base to block water flow to filter.
- Twist the filter cartridge counterclockwise about a quarter-turn and pull it down and out of the filter head.

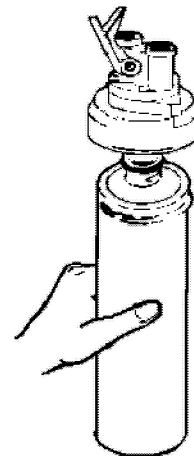

- Insert a new water filter cartridge up into the filter head as far as possible and turn it clockwise a quarter turn.
- Lower valve handle to lock filter and restore water flow.

See “Winterizing the Water Purifier System” in Section 10.

EXTERIOR SHOWER

The exterior auxiliary shower is located in the water center compartment. This feature allows you to do things such as rinse off sand or salt after a swim, rinse off muddy boots, or bathe your pet outside the coach.



Exterior Shower

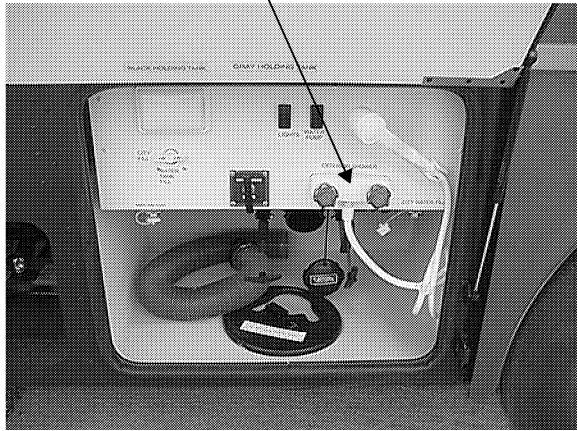

tank. Grey water also rinses any black water solids from the drain hose.

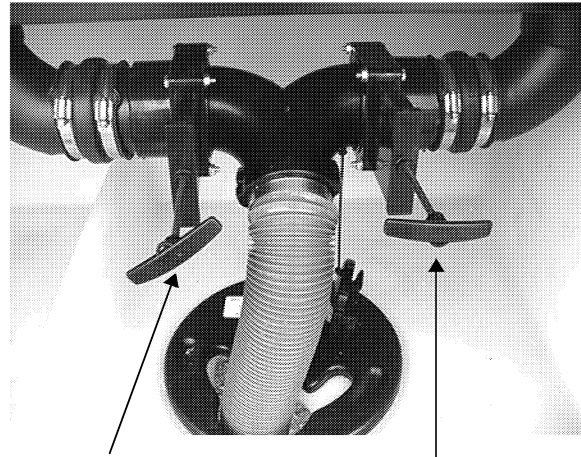

1. Pull black water first
2. Pull grey water last



WASTE WATER SYSTEM (HOLDING TANKS)



The drainage system is self-contained and uses two separate holding tanks to contain the waste water until it can be dumped at an appropriate waste water disposal site. This means you can use the toilet, sinks and shower even in areas where utility hookups are not available.

The main holding tank contains the sewage from the toilet, and is commonly called the *black water tank*. The second holding tank contains the waste water from the galley sink, bathroom lavatory and shower, and is commonly called the *grey water tank*.

3. Close sewage valve and open waste (grey) water dump valve with a quick pull. Close valve handle as soon as tank is empty.
4. After both tanks have been drained, run several gallons of water into the sewage tank through the toilet. Then open sewage dump valve and drain the tank again. Close valve when done.
5. It is advisable to add an odor control chemical to the sewage holding tank. These chemicals are available at most R.V. stores.
6. Rinse end of sewer hose thoroughly with water and stow.

NOTE: We recommend that you dump all holding tanks before traveling to avoid carrying unnecessary weight.

DUMPING HOLDING TANKS

1. Attach the drain hose and place end of sewer hose into disposal opening.
2. Open the sewage (black tank) valve with a quick pull. **OPEN ONE VALVE AT A TIME.** Move hose gently about to dislodge any waste and to ensure complete drainage.

NOTE: Do not open the grey tank valve until the black tank is drained and dump valve closed to avoid sewage back-up into grey



Flushing your Black Water Holding Tank

The black water holding tank is equipped with an internal spray head that allows you to rinse the inside of the tank with a shower of clean water after dumping.

1. Dump your black water holding tank in the usual manner at approved sewage disposal station.



2. Leave black water dump valve open while flushing tank.
3. Attach a garden hose from a city water hydrant to the Flushing System inlet fitting in the water system compartment. (This inlet is clearly marked separate from the City Water inlet.)

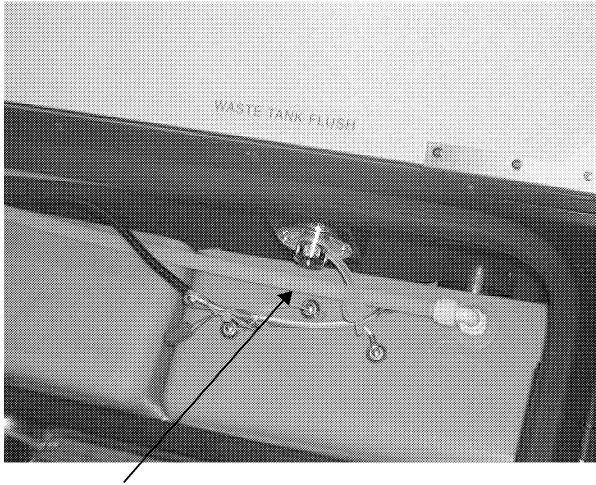

Flushing System Inlet

4. Turn the water on to begin flushing; allow water to run for about three minutes.
5. Disconnect hose from flushing system fitting and close dump valves.

USING ON-SITE SEWER HOOK-UPS

The drain hose may remain attached to the dump outlet and be routed out the bottom of the compartment while the motor home is parked and connected to an on-site sewage hook-up.

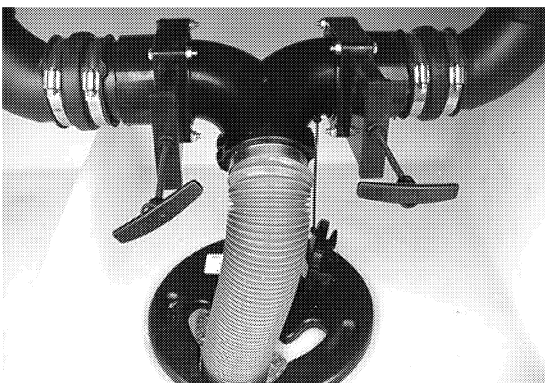

Drainage Hose
routed through passage in compartment

When using a sewer hook-up, keep the dump valves closed until a tank becomes full or when preparing to leave the site. This keeps the solids in suspension, allowing them to be carried out with the liquids when the dump valve is opened. If the valve is left open, the liquids will drain off, leaving solids in the tank. Should this accidentally happen, disconnect the hose, fill the tank about half full with water, and drive a few miles to dislodge the solids. A few starts and stops will aid in the process. Then reconnect the hose and drain in the normal manner.

UTILITY LIGHT

A lamp is located up on the left sidewall to provide light in the utility hook-up area.

The switch is located inside the compartment on the left side of the coach.

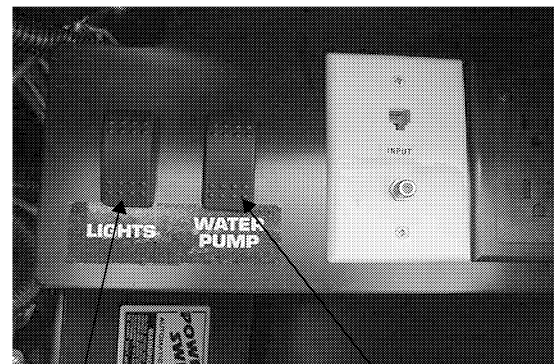

Tank Monitor
Panel

Panel, Light & Pump Switches

WATER DRAIN VALVES

The water drain valves are used to drain water from the water tank and the water supply lines when preparing the motor home for storage or when sanitizing the water system.

To Drain Tanks and Water Lines:

The water line drain valves are located in the water center compartment on the driver side toward the rear of the coach. Turn the valves as indicated in the following illustration, according to the type of valve installed.

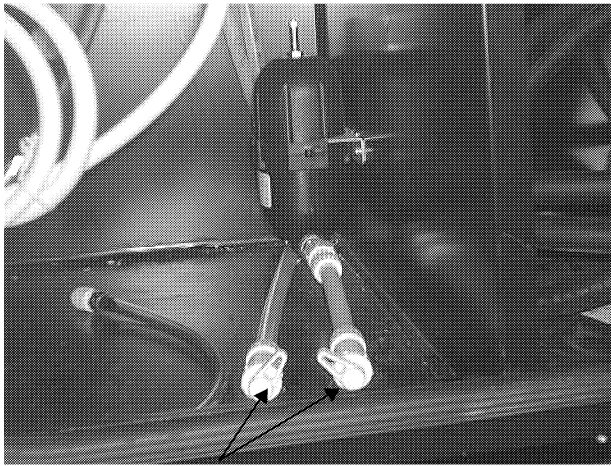

Water Line Drain Valves
(in water center compartment)



Water Tank Drain Valve
(pull to open)

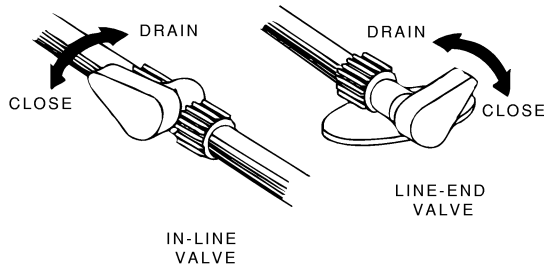

Water Drain Line Valves
(typical)

The fresh water tank drain valve is operated by pulling on a T-handle for a cable that is located either in the water service center or in the waste dump valve compartment, depending on model. (See photos below).

- Open both Hot and Cold water line valves.
- Turn water diverter valve to WATER TANK FILL position.
- Open shower line drain valve inside coach.

Water Heater Drain Plug: The water heater drain plug is located on the outside of the coach behind the water heater service panel. Use a socket to remove the plug.

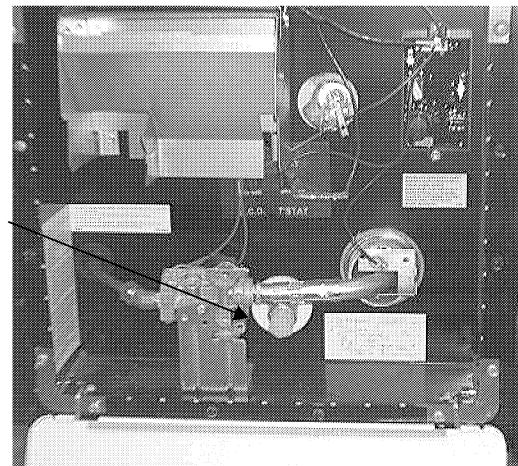

Drain Plug

Water Heater
Service Access



HOLDING TANK CAPACITIES



Black Water Holding Tank (Toilet)..... 48 gal.



Grey Water Holding Tank (Galley, Shower & Lavatory)..... 52 gal.

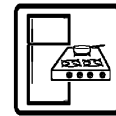

(See also Safety Precautions, Section 1 of this manual.)

NOTE: Some items described in this section may be optional and, therefore, may not be in your vehicle.

The appliances installed in your motor home are manufactured by reputable RV appliance makers and have been tested by independent laboratories to meet all applicable standards and codes set for RV appliances. These appliances are covered by your New Vehicle Limited Warranty. (Certain items may be covered by individual manufacturer's warranty.) See your New Vehicle Limited Warranty for details.

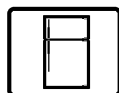

Refrigerator

The refrigerator in your coach can be operated from either of two power sources available to the motor home:

- 110-Volt AC electric
- LP gas

The refrigerator is an absorption type which uses an ammonia-water solution for cooling. Basically, ammonia vapor is distilled from the solution by heat, produced from either LP gas or electricity and then carried to the finned condenser where it liquefies. The liquid then flows to an evaporator where it creates cold temperatures through evaporation.

Leveling

Always park the vehicle on a level location when operating the refrigerator while parked. Operating the refrigerator off-level for longer than 1 hour can result in a form of 'vapor lock' that could permanently damage the refrigerator. Normal vehicle leveling to provide comfort for the occupants is generally satisfactory for refrigerator operation.

A small round bubble level is provided with your refrigerator. Place the bubble level on the bottom surface of the refrigerator and watch the position of the bubble in relation to the circle in top of the level.



Place bubble level in bottom of refrigerator

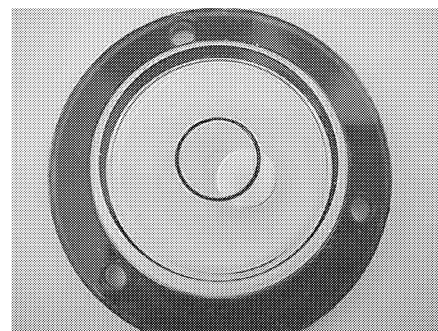

If over 1/2 of the bubble is inside the circle in any direction, the coach is level enough for continuous operation of the refrigerator while parked.

CAUTION

To prevent permanent damage to the refrigerator cooling unit, turn the refrigerator off if the vehicle will be parked on an incline of over 3° side-to-side or 6° front-to-rear (such as steep driveways or parking lots, etc.) for more than one hour.

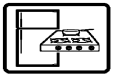

Normal vehicle leveling to provide comfort for the occupants is satisfactory for refrigerator operation. This will be well within the operation limits of 3° off-level side-to-side and 6° off-level front-to-back.

OPERATING INSTRUCTIONS



Push door handle downward and pull to open refrigerator. (Lift freezer handle upward.)

Standard Norcold 9000-Series models with Electric Auto Mode Control

The control panel is located between the freezer compartment and fresh food compartment. It contains pressure sensitive touch switches and a digital display. A backlight illuminates the display for 10 seconds whenever any of the control buttons is pressed.

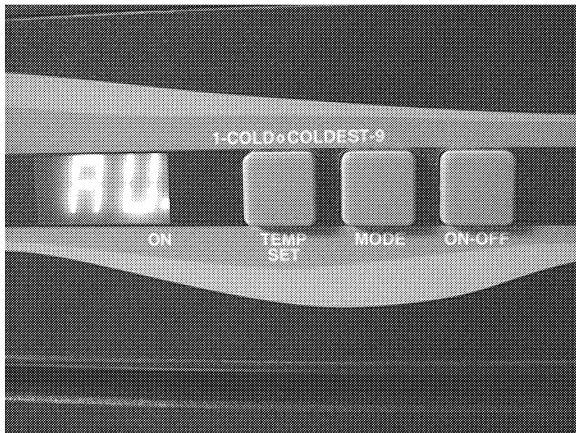

The ON/OFF button turns the refrigerator on or off. If the button is pressed, it will turn the

refrigerator on and set the mode to auto. When the refrigerator is on, pressing this button for 2 seconds will turn the refrigerator off.

Pressing and holding the MODE button allows the user to cycle through the three mode choices; one AUTO and two manual modes (AC, LP GAS). The refrigerator will not switch to the new operating mode until the mode button is released.

The TEMP SET (thermostat) button controls the refrigerator and freezer temperature during both gas and electric operation, eliminating the need to reset each time a different power source is selected. Press and hold the TEMP SET button to select the desired temperature setting. The temperature settings are shown in the form of a number (A) in the display window, with the highest number indicating the coldest setting.

Start-Up Instructions - Auto Mode

When the AUTO mode is selected, the operating control automatically selects the power source using the following priority scheme:

- First, the auto mode system will 'seek' to find AC power available. At this time 'AU' will appear in the display window.
- When 120 volts AC is available to the refrigerator, 'AC' will appear in the display panel, indicating the refrigerator is operating on AC electric.
- If 120 volts AC is not available, the refrigerator will switch to the gas operation, and 'LP' will appear in the display panel.

During operation in the AUTO mode, when a higher priority power source becomes available, the operating controls will cease using the current power source and will switch to the higher priority power source. For example, if AC electric becomes available while the refrigerator is operating in the AUTO LP GAS mode, the refrigerator will switch to AUTO AC operation.

If an operating mode is not functional, a diagnostic code will appear and the refrigerator will attempt to operate in a lower power priority source. If a lower power priority source is not available, an alarm will sound and the refrigera-

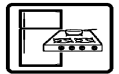

tor will cease operation. Refer to the *Diagnostic Codes and Their Meaning* for corrective actions.

Start-Up Instructions - Manual Mode

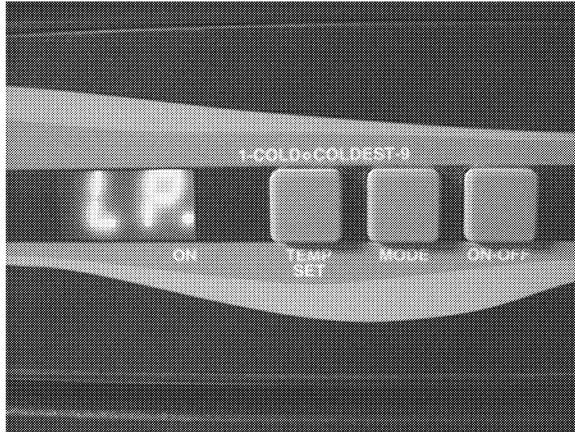

To operate in the MANUAL mode, press and hold the MODE button until AUTO disappears and the desired operating mode is displayed. If the power source is interrupted while operating in the MANUAL mode, a diagnostic code will appear, an alarm will sound, and the refrigerator will cease operation. For corrective actions, refer to the *Diagnostic Codes and Their Meaning* on page 10 of the Norcold Operator's Guide in the blue binder.

AUTO and MANUAL Modes - Gas Operation Only

If the gas does not ignite within 30 seconds, which may occur on initial start-up, the refrigerator's gas valve will automatically close and the operating controls will select an alternate power source (AUTO Mode) or MANUAL mode, will revert to a stand-by mode in which an alarm will sound and code A1 will be displayed in the center window. The alarm and code will remain on until the operating controls are turned OFF and then ON again. If the gas does not ignite after several attempts, check the input gas supply, or consult with your dealer or a Norcold authorized service center. A different mode of operation may be selected by pressing and holding the MODE button. The refrigerator will not switch to the new operating mode until the MODE button is released.

Backup Operating System (BOS)

Your refrigerator features a Backup Operating System which keeps the refrigerator cool in the event of a failure of the refrigerator's operating controls. If a failure occurs, the refrigerator will display Diagnostic Code C5 and will switch automatically to the BOS mode. This mode provides refrigeration until the refrigerator is serviced. The fresh food and freezer compartment temperatures should be monitored to prevent over-freezing or thawing of refrigerator contents when operating in the BOS mode. If the refrigerator temperature is too cold, adjust the thermostat up (warmer) in one bar increments. If the refrigerator temperature is too warm, adjust the thermostat down (colder) in one bar increments. Let the refrigerator operate at the new setting for one hour before rechecking the freezer and fresh food compartment temperatures. (Frequent door opening prevents the temperatures from stabilizing.) Although the refrigerator can operate in this mode, Norcold recommends that you seek service to restore normal operation as soon as practical.

Humidity - Storage Switch

Turning this switch to HIGH HUMIDITY will keep the surface between the door openings dry during high humidity conditions. The switch should be left in the NORMAL OPERATION position unless moisture collects around the door.

When storing your RV for the winter, place this switch in the STORAGE (LIGHT OFF) position. This shuts off all DC power to the light and humidity heater and allows the refrigerator door to be left open for airing without draining the battery.

Operating Tips

- The refrigerator should already be cold before placing items in it.
- Food and beverages should also be cold before placing in RV refrigerator. Never put warm or hot items in a cold refrigerator.

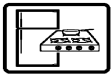

- Do not pack the refrigerator too full. The refrigerator needs room for cold air to circulate.
- Use smaller containers for each item. (e.g. a half gallon container of milk instead of a half-full gallon jug)
- Always put foods, especially liquids, in tightly sealed containers.
- Use crumpled paper between loose items to reduce rattling or “clinking” noises.

Further Information

For further information and operating cautions, see the Norcold refrigerator operating instructions included either inside the refrigerator or in your Owner InfoCase.

ICE MAKER - Norcold

Some Norcold refrigerators are optionally equipped with an automatic ice maker system. The ice maker unit is installed in the freezer compartment of the refrigerator.

The ice maker does not freeze the ice. The refrigerator freezer compartment does the actual freezing of the water. The ice maker simply senses when the ice is ready, ejects it into the ice bin, and refills the molds with water for another ice cycle. When the ice bin is full, the amount of ice will raise an automatic shutoff arm which stops the ice maker. Some problems involving lack of ice production - particularly a lack of freezing - may be the fault of the refrigerator rather than the ice maker.

Operating the Ice Maker

1. Connect the coach shoreline to a 110VAC source and switch the refrigerator to AUTO (AC electric) mode. The ice maker motor runs on 110-volt current only.
2. Connect the coach to an external (city water) source or leave water pump switch on continuously to provide a constant water supply.
3. Be sure the ice bin is in place and the ice maker's automatic shut-off arm (wire) is in the down (automatic) position. If the arm is up, the ice maker will not operate.

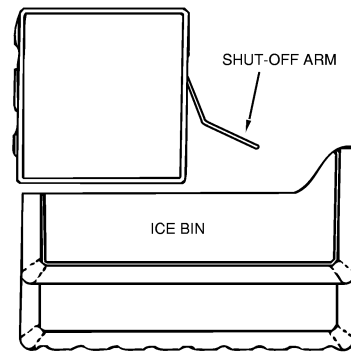
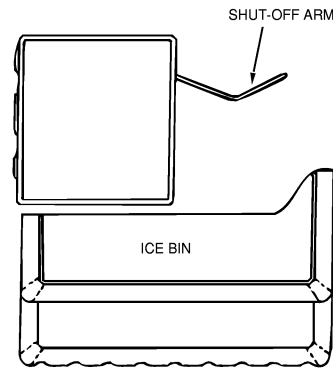

4. Start the refrigerator the day before ice cubes are needed. When the refrigerator is started (from room temperature), it is normal to take as long as 24 hours to become cold enough to make the first batch of ice cubes.
5. Always discard the first batch of cubes made in a new ice maker. The new plumbing lines and connections may cause discolored and bad tasting ice. The ice maker will make up to 3 lbs. of ice in 24 hours, if the freezer temperature is 14 F or below.
6. To remove the ice bin, raise the automatic shut-off arm (off). When returning the ice bin to the freezer, remember to lower the shut-off arm (on). If the arm is up, the ice maker will not operate.

Shut-Down of Ice Maker

To turn the ice maker off, simply raise the shutoff arm (wire).

Winterizing the Ice Maker

When winterizing, make sure the water line is completely drained by following this procedure.

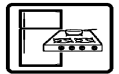

1. Drain coach water lines. See Sect. 10.
2. Unscrew the water supply line from the bottom of the water inlet valve and drain any water left in the line. This connection is located in the refrigerator service compartment on the outside of the coach. (See Refrigerator Service Access Compartment on the following page.)

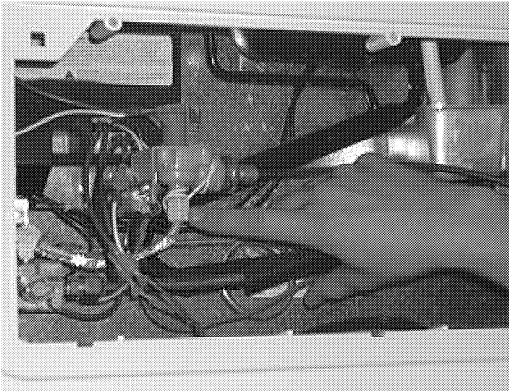

Ice Maker Water Supply Connection

3. Let the ice maker run through a cycle, then raise the shut-off arm.
4. Be sure water has drained from ice maker supply line, then reconnect to inlet valve.

Start-Up (Removing from Storage)

1. Close all drain valves.
2. Turn the water supply on.
3. Be sure the ice bin is in place and the automatic shutoff arm is down.
4. Let the refrigerator cool down to ice making temperature. Remember, this can take up to 24 hours.
5. Let the ice maker cycle and dump the first batch of ice.

Troubleshooting the Ice Maker

1. **Is 110-Volt AC reaching the refrigerator?**
 - A. Ice maker motor needs 110VAC to operate.
 - B. Be sure refrigerator power cord is plugged in.
 - C. Check appropriate breaker on 110VAC breaker panel.

2. **Is 12-Volt DC reaching the refrigerator?**
 - A. Refrigerator eyebrow control and power supply board both need 12VDC to operate.
 - B. Check 12V fuse or breaker on converter panel
3. **Is water supply pressure at least 15 psi, but no more than 125 psi?**
 - A. If not enough, turn city water faucet open further or check for blockage.
 - B. If too much, attach water pressure regulator.
4. **Is the water supply inlet valve on?**
 - A. If not enough, turn city water faucet open further or check for blockage.
 - B. If too much, attach water pressure regulator.
5. **Is the freezer compartment temperature 14° F or lower?**
 - A. Turn refrigerator temperature control to colder setting, if needed.
6. **Is the ice maker's automatic shut-off arm in the down (on) position?**
 - A. If arm is not down, ice maker will not operate.
7. **Has it been at least 24 hours since the refrigerator was turned on?**
 - A. If not, allow more time.
 - B. If so, refer to Norcold refrigerator freezer troubleshooting procedures in your dealer service library.
8. **Water not filling molds:**
 - A. Water inlet valve off (on back side of refrigerator).
 - B. Insufficient water pressure.
 - C. Water line blockage.
 - D. Faulty water solenoid - stuck off.
9. **Water over-filling molds:**
 - A. Excessive water pressure.
 - B. Faulty water solution - stuck on.
10. **Water not freezing:**
 - A. Refrigerator problem.
11. **Ice not ejecting:**
 - A. 110VAC power not connected.
 - B. Mold heater not working - replace ice maker.
 - C. Ejector motor not working - replace ice maker.

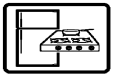

12. Ice bin overflowing:

- A. Shutoff switch broken.
- B. Shutoff wire stuck.

13. Low ice production:

- A. Water not freezing fast enough - refrigerator problem.

14. Freezer needs defrosting often:

- A. Ice maker motor and mold heater add heat to compartment, which develops frost. This is normal.
- B. Check door gasket for proper sealing.

REFRIGERATOR SERVICE ACCESS COMPARTMENT

(Exterior)

The exterior refrigerator service compartment allows access to the rear of the refrigerator for inspection, maintenance and service.

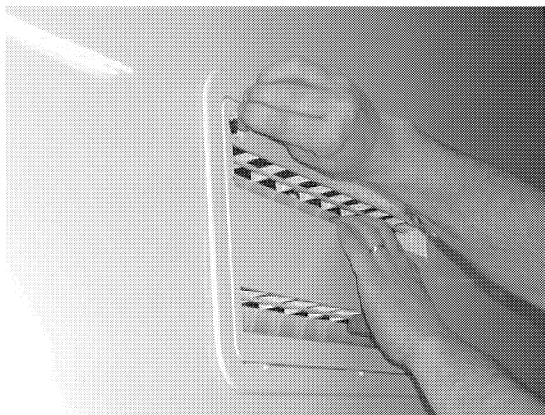

Turn latches open with coin

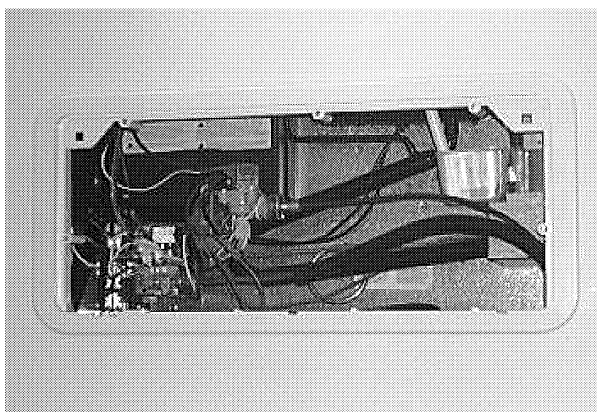

Refrigerator Access Compartment



LP GAS COOKTOP

The cooktop in your motor home operates on LP gas and will provide the same functions that the range in your home does.



Gas Cooktop

The following warning label has been located in the cooking area to remind you to provide an adequate supply of fresh air for combustion.



Unlike large homes, the oxygen supply inside a recreational vehicle is limited due to its size. To avoid danger of asphyxiation, provide proper ventilation when using the gas cooktop. It is especially important not to use the gas cooktop for comfort heating. Danger of asphyxiation is greater when these appliances are used for long periods of time.

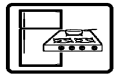

WARNING

Portable fuel-burning equipment including wood and charcoal grills and stoves, should not be used inside the recreational vehicle. The use of this equipment inside the recreational vehicle may cause fires or asphyxiation.

Lighting Cooktop Burners (w/Pilotless Ignition)

1. Be sure LP gas tank main supply valve is open.
2. Rotate the Spark knob clockwise to provide ignition spark.
3. While rotating the Spark knob, turn the selected Burner knob to ON.
4. When the burner lights, release the Spark knob and turn the Burner knob back toward OFF position to adjust the flame height.



Rotate knob in direction of arrow while turning burner on to light

Further Information

See the Cooktop *Use and Care Guide* in your Owner InfoCase for more precautions, operating and care instructions.

MICROWAVE/CONVECTION OVEN

For complete operating instructions, refer to the manufacturer's information provided with the oven.

RANGE HOOD

The range hood vent is built into the underside of the microwave oven. The range hood fan draws cooking odors and gas fumes through a filtering system and recirculates the air. A light on the underside of the hood provides illumination for food preparation. The hood fan and light switches are located on the microwave control panel.



See the manufacturer's information in your Owner InfoCase for instructions on replacement of light bulbs and grease filter elements.



ONEPLACE™ SYSTEMS MONITOR PANEL

The ONEPLACE Systems Monitor Panel provides a convenient, central location for checking the condition of all utility systems in your coach. It also includes the TRUEAIR climate control thermostat and the POWERLINE Energy Management System status panel.

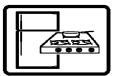

At the touch of a button this panel can display the fresh water and holding tank levels, LP gas tank level, plus the engine battery and coach battery condition. You can start the auxiliary generator or turn on the water pump and water heater. Indicator lights tell you if the water pump is on or if the water heater pilot light is out.



One Place Monitor Panel

Generator Start/Stop Switch

See Section 6, Electrical Systems for generator start-up and shut-down instructions.

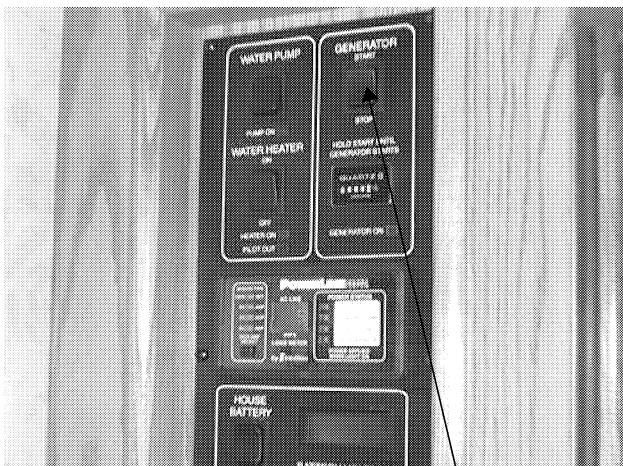

Generator Switch and Hourmeter

Generator Hourmeter

See Section 6, Electrical Systems for generator hourmeter information.

Water and Holding Tank Levels

Press and hold the “Levels Test” switch to show approximate level on the monitor lights.

The approximate water levels are measured by sets of electronic probes in the sides of the tanks, so the water must be touching a probe to register at that level. There is generally more water in a tank than indicated on the monitor panel.

For example, a water level of 1-2” below the FULL probe, the monitor will show the level to be only 2/3 even though the tank is nearly full. If the water level is below the 1/3 probe, the monitor will register an empty tank because the water is no longer touching the 1/3 probe. There may actually be some water left in the tank. However, when the indicator reads FULL, the tank is actually full.



Tank Capacities

See back of “To The Owner” page inside front cover of this manual.

LP Gas Level

Press and hold the “Levels Test” switch to show approximate LP tank level.

The LP level is registered by a sending unit on the tank. The gauge mounted on the side of the tank will give a more accurate indication of actual tank level if needed.

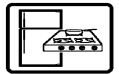

Water Pump Switch

When you want to use the self-contained water system, turn on the “Water Pump” switch on the monitor panel. The “Pump On” light will illuminate when the pump switch is turned on. Water will be available as soon as a faucet is opened.

For your convenience, additional switches are located in the bathroom and in the water center compartment.

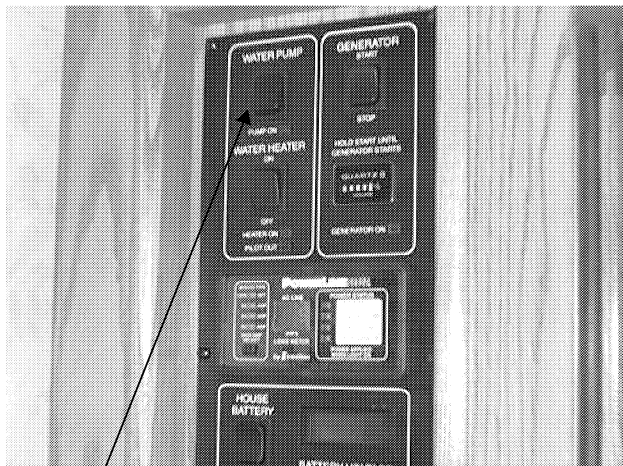

Water Pump
Switch

Battery Condition Meter

Push the “Levels Test” button to check the level of charge (voltage) in the 12-volt coach battery. The indicator segments will light from the bottom up to the amount of charge the battery contains.

To get an accurate reading;

1. Both the chassis engine and the auxiliary generator engine must be shut off.
2. An interior light should be turned on to provide a small load which draws off the battery surface charge.



WASHER-DRYER (Optional)

For complete operating instructions, see the manufacturer’s information provided in your Owners InfoCase.



The washing machine water supply faucets are located inside the cabinet door above the machine. Always turn supply faucets off when not using washing machine to avoid possible water leaks if a hose or hose gasket should fail.

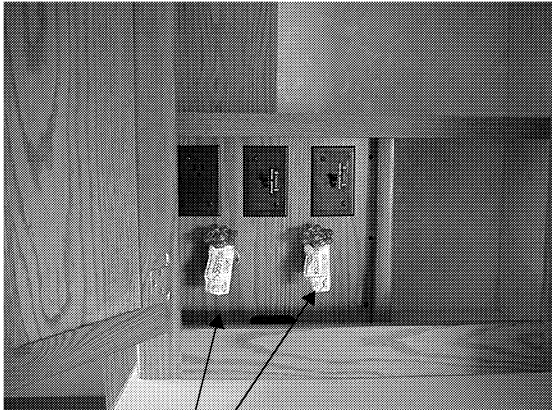
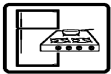

Water Supply
Faucets

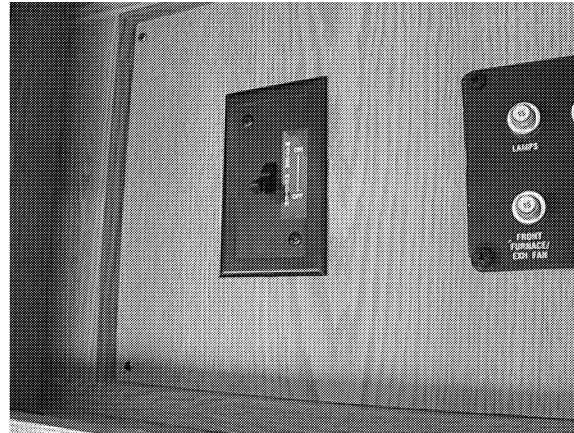

Electric Water Heater Switch
(Typical)

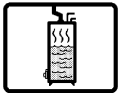

**GAS/ELECTRIC
WATER HEATER**
**(with Motor Aid water heating
system)**

Capacity: 10 gal.

The optional 10 gallon gas/electric water heater has a dual power feature. It can operate from LP gas or 110-volt house current; or it can use both at the same time for quicker recovery at times when you are using a lot of hot water.

Read the Atwood Gas Water Heater Installation and Operation Manual for complete Safety Warnings, Operating Instructions and Maintenance Information before operating the water heater.

Be sure the water heater is filled with water before starting either electric or LP operation. To fill the water heater, turn the Water Pump switch on and open a hot water faucet anywhere in the coach. When water begins to flow steadily from the faucet, the water heater is full.

For Electric Operation: Turn on the Water Heater electric element switch. The shoreline must be connected for electric operation.

For LP Gas Operation: Press the Water Heater switch on the Monitor Panel. The “Pilot Out” light will glow for about 10-15 seconds, then it will go out. The “Heater On” indicator will remain lit. If the “Pilot Out” light comes on during LP operation, it means that the burner has gone into “lockout” mode and must be restarted. If this happens, turn the Water Heater switch off for about 5 minutes, then turn it back on. See the Atwood user’s guide in your Owners InfoCase for further information.

**Water Heater Switch and
“Pilot Out” Indicator**

Be sure the water heater is filled with water before pressing this switch. To fill the water heater, turn the water pump switch on and open a hot water faucet until water begins to flow.

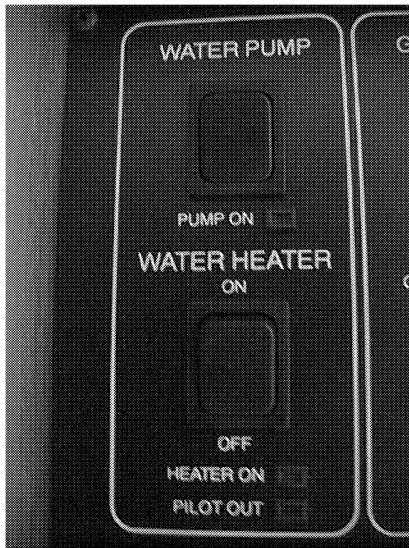
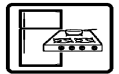

For Quick Recovery Operation (Dual):

Turn On both Water Heater switches; the gas one on the monitor panel and the electric one. This will help reheat the water heater tank more quickly than a single source would alone. Use this mode when you are using a larger than normal volume of hot water, for example, when someone is taking a shower and the dishwasher or clothes washer is also being used.

Gas Safety Information

- A. This appliance does not have a pilot light. It is equipped with an ignition device that automatically lights the burner. Do Not try to light the burner by hand.
- B. Before lighting, smell around the appliance area for gas. Be sure to smell near floor because LP gas is heavier than air and will settle on the floor.

WHAT TO DO IF YOU SMELL GAS

- Do not try to light any appliance.
- Do not touch any electrical switch.
- Get out of the coach immediately and turn off the LP gas tank at the main tank valve. (See photo on page 5-2.)
- Use a neighbor's phone to call your Winnebago Industries dealer or a local gas supplier for instructions. Do not use a phone in

your coach. Follow the dealer's or gas supplier's instructions.

- If you cannot reach a Winnebago Industries dealer or a local gas supplier, call the fire department.
- Have the source of the leak corrected before using the LP gas system again.

Operating Instructions

1. STOP! Read the safety information provided in the Atwood Water Heater Operation Manual in your Owners InfoCase.
2. Turn off water heater power switches.
3. Turn LP gas supply off.
4. Wait five minutes for any gas to clear the area. If you smell gas, then stop and follow item B of the Safety Information above. If you don't smell gas, go to the next step.
5. Turn on LP gas main tank valve.
6. Turn on the water heater switch on the monitor panel. You may hear a clicking noise as the ignition element begins working. If the burner does not light on first try, the system will stop trying to light burner and go to lockout mode.
7. If lockout happens before main burner lights, turn switch OFF, wait five seconds and turn switch back on. This will restart the ignition cycle. The first start-up of the water heater after it has not been used for a long time may require several ignition cycles before all the air is purged from the gas lines and gas begins to flow.

If the burner will not come on, check the following items before calling for service.

1. Is the switch turned on?
2. Does the LP tank have gas in it or is main tank valve turned on?
3. Is the ECO Reset button tripped? (See *Atwood Water Heater Operation Manual* in your Owners InfoCase.)

To Turn Water Heater Off

1. Turn switch on monitor panel to Off position.
2. Turn electric water heater switch off.

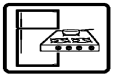

3. Turn off LP gas supply (if not to be used for extended period).
4. Drain water heater tank if the coach is to be stored or water heater will be Off during freezing temperatures. (See Draining and Storage Instructions in *Atwood Water Heater Operation Manual* in your Owners InfoCase.

Pressure-Temperature (P-T) Relief Valve

On occasion, water may be seen seeping from the water heater pressure-temperature relief valve. This is no cause for repair or replacement of the valve.

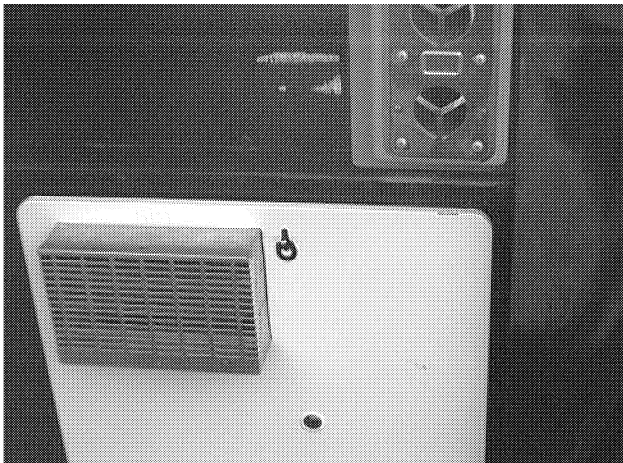

Water Heater Service Access Panel

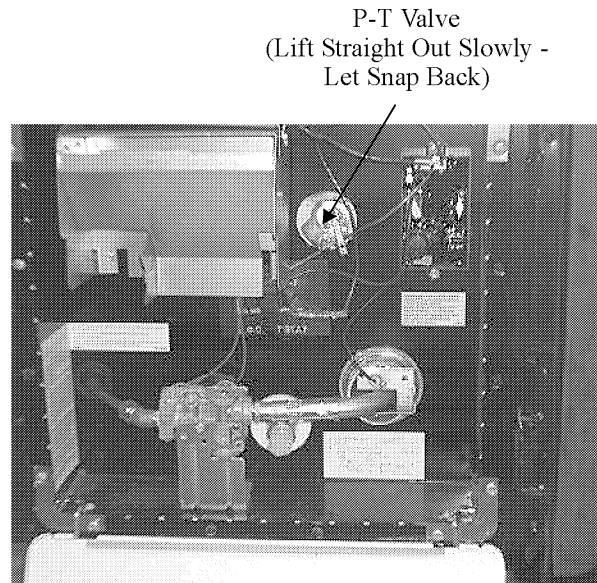

Water Heater - Exterior Service View

The water heater tank is designed so that there is normally an air pocket at the top of the tank that acts as a pressure buffer. In time, however, heated water may expand and fill this air pocket, causing a slight increase in water pressure. This may cause the P-T valve to “weep” until the air pocket is manually replaced.

OPERATE THIS VALVE ONLY WHEN THE WATER HEATER AND COOLING SYSTEM ARE COLD!

To Replace the Air Pocket:

1. Turn off the water heater switch and incoming water supply (city water and/or demand pump).
2. Open a faucet in the motor home to relieve water pressure.
3. Pull the handle of the P-T valve straight out and allow water to flow until it stops.

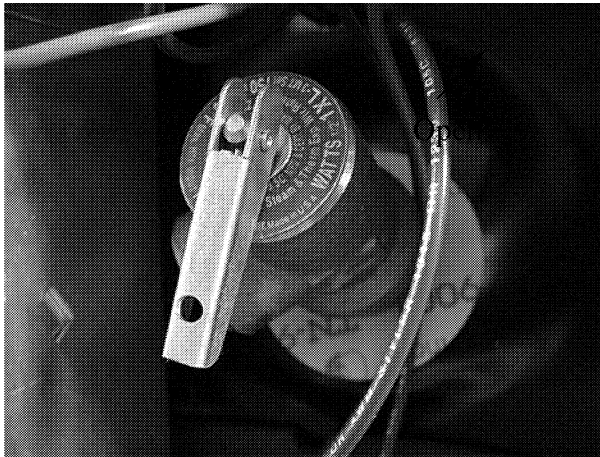
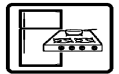

Lift handle straight out to open P-T valve.

4. Let the handle of the P-T valve snap shut.
5. Close the faucet and turn on the water supply before switching the water heater on.

Manually operate the pressure temperature relief valve at least once a year.

MOTOR AID (Optional 10 gal. Water Heater only)

(Not available on Freightliner diesel chassis)

The motor aid uses heat from the chassis engine cooling system to heat water in the water heater while driving. Hoses are routed from the engine to a heat exchanger surrounding the water heater tank.

Under normal conditions, the entire contents of the water heater can be heated to about 140°F in about two hours or 100 miles of driving. This means you can have hot water at the faucets immediately upon arriving at a site, or even while driving if needed.

The motor aid also increases the capacity of the engine cooling system, allowing the engine to run cooler under many conditions.

CAUTION

Any leak in the heat exchanger or its supply or return lines could cause loss of coolant and subsequent engine failure. We recommend that you periodically inspect these connecting lines and the heater to insure that no leaks have developed.

Motor Aid Water Heater and Auxiliary Coach Heater Maintenance

Have your authorized dealer check all hose clamp connections on the rear automotive heater and the motor aid water heater at least every six months and tighten them if necessary.

WATER HEATER BY-PASS VALVE

Your coach is equipped with a water heater by-pass valve for easier winterization of water lines using RV antifreeze. The valve is located on the valve panel in the water center.

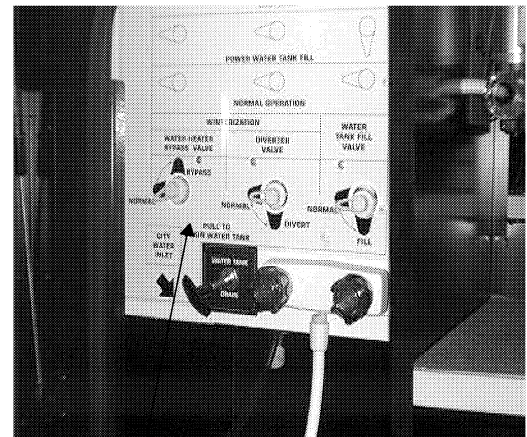

Water Heater By-Pass Valve

CAUTION

Leave by-pass valve handle in NORMAL FLOW position if draining water and blowing out water lines. Place in BYPASS position ONLY when using antifreeze solution in water lines.

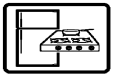

NOTE: Your coach is not equipped with this valve if you have the optional automatic winterization system.



**LP GAS FURNACE
(SUBURBAN)**

To Start Up:

1. Open the LP gas tank valve by turning fully counterclockwise
2. Move FAN MODE switch to Auto and place FAN SPEED switch in desired position - Lo or Hi.
3. Move THERMOSTAT switch from Off to Heat and press the Temp Selector button (Up/Down arrows) until the desired temperature is shown in the display.
4. Furnace fan will start to blow immediately after setting thermostat.
5. After about 30 seconds, the furnace burner will light.
6. The furnace will now cycle off and on automatically as the thermostat demands just like a household furnace.

NOTE: If heat does not come out of the heat ducts after a minute or so the burner is not lit. Turn thermostat off for 3-5 minutes, check to be sure tank valve is open and tank is not out of fuel, then try steps 2-4 again. If it still will not light after three attempts, go to Shut Down steps and contact your dealer or a local RV service center.

To Shut Down:

1. Slide thermostat/system switch OFF.
2. Close LP tank valve.

For Further Information

Please see the Suburban furnace operating instructions provided in your Owners InfoCase for further information, including operating precautions, and periodic maintenance.

**ELECTRONIC THERMOSTAT
(Central Heat/Air Conditioning System Only)**

The thermostat, on the One Place panel, controls heating, air conditioning and cooling fan features.

Temperature Selector

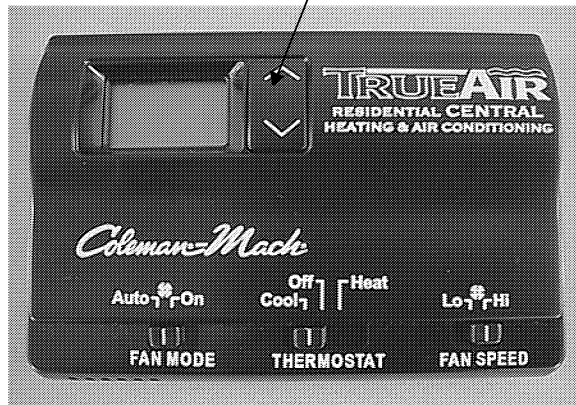

True Air Thermostat

NOTE: The thermostat does not automatically switch between heating and cooling. You must place the thermostat switch in the desired position.

Heating:

- Slide the thermostat switch to “Heat” position.

NOTE: Follow proper furnace lighting procedures described previously in this section.

NOTE: If your coach is equipped with the optional electric Heat Pump, be sure the Thermostat switch is in Gas Heat position. See Heat Pump for details.

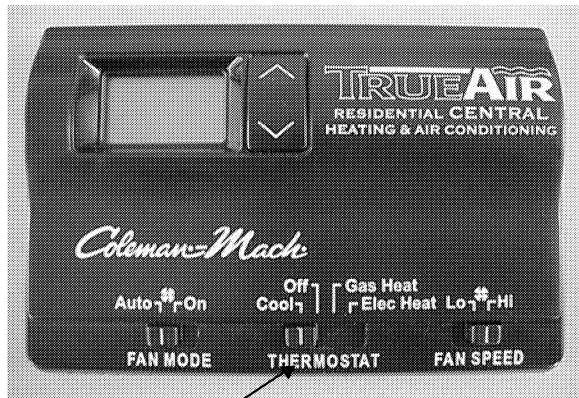
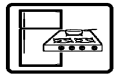

Heat Source Switch
ELECTRIC = Heat Pump
GAS = Furnace

- Adjust the temperature setpoint to personal preference if needed. See “Changing Temperature Setpoints.”

Digital Thermostat Display

The digital display normally shows current room temperature, with the word “ROOM” in small letters at the left side of the display. When you press the temperature selector button up or down, the display will show the word “SET” and the new temperature setpoint until you release the button.

Change Temperature

To set the temperature to a new temperature, simply press the Temperature Selector button up or down until the temperature you want appears in the display. The word “SET” will also appear at the left side of the display while you are changing the temperature setpoint. A few seconds after you release the temperature selector button, the display will return to showing the current room temperature.

Cooling (A/C):

- Slide the thermostat switch to Cool position.
- Slide the Fan Mode and Fan Speed Switches to the desired positions.

On/Low: A/C compressor cycles on and off with the thermostat while fan runs continuously at low speed.

On/High: A/C compressor cycles on and off with the thermostat while fan runs continu-

ously at high speed.

Auto/Low: Fan runs at low speed and cycles on and off with the A/C compressor as controlled by the thermostat.

Auto/High: Fan runs at high speed and cycles on and off with the A/C compressor as controlled by the thermostat.

- Adjust the temperature setpoint to personal preference if needed. See “Changing Temperature Setpoints”.

To Run Fan Only (No Heat or Air)

- Set Thermostat switch to OFF.
- Slide Fan Mode switch to On.
- Place Fan Speed switch to Lo or Hi as desired
- The fan will run continuously at the selected speed and is not controlled by thermostat setting. The display will show current room temperature.

HEAT PUMP - Optional

Your coach may be optionally equipped with an air source heat pump built into the central air conditioning system. Because the heat pump operates on electricity, it provides economical heat inside your coach and helps reduce the use of LP gas for heating in cooler weather.

A heat pump can be thought of as an air conditioner running in reverse. An air conditioner absorbs heat from the air inside of the coach and moves it to the outside. The heat pump does exactly the opposite. Even cold air contains some heat, so a heat pump will extract heat from the outside air on a cold day and carry it to the inside of the coach to maintain a comfortable temperature.

The efficiency of a heat pump decreases as the outdoor air temperature drops, so supplementary heat is often needed when the outside temperature nears freezing. This system is set to automatically start the LP gas furnace to assist the heat pump if room temperature cools to 5 degrees F or more below the thermostat setpoint. You may wish to manually switch to furnace heat to maintain a higher temperature when outside temperatures begin to reduce the efficiency of the heat pump. The heat pump will not operate when the outside temperature falls below 36 degrees F.

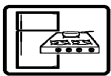

To Operate the Heat Pump:

- Slide the thermostat switch to electric heat mode.
- If the inside temperature is 5 degrees or more below the thermostat set point, both the heat pump and the furnace will run initially to bring the interior temperature up to the set point as quickly as possible. (If the inside temperature is 4 degrees or less below the set point, then only the heat pump will run initially.)
- When the thermostat calls for heat again, only the heat pump will run. The heat pump will remain the sole heat source unless it cannot maintain the inside temperature. If the inside temperature falls five degrees below the set point, the furnace will assist the heat pump until the set point is reached.

If the furnace must assist the heat pump three times in a row, the thermostat will shut down the heat pump for two hours and the furnace will take over as the heat source. After two hours the heat pump will become active again and try to be the primary heat source.

The furnace acts as a standby heat source if the outside temperature drops below a point that the heat pump can no longer extract heat from the outside air to maintain the desired inside temperature.

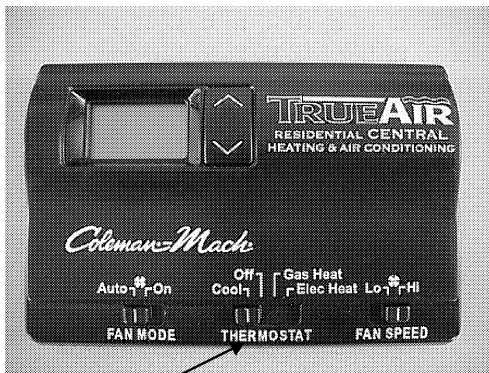

Thermostat Switch
Gas Heat = Furnace Only
Elec Heat = Heat Pump

Have you checked your air filter lately?

Closed or blocked vents and a dirty air filter can hinder the efficiency of a heat pump. See Air Conditioner Filter for location and instructions.

- Be sure ceiling vents are open to distribute heat pump output air. Also make sure furniture, clothing items, packages or other obstructions do not block the air return air grilles beneath the rear bed.
- The filter should be checked monthly for dirt build-up and replaced as needed. The air filter is a disposable woven fiberglass type, which cannot be cleaned and should be replaced when coated with dust.



CENTRAL AIR CONDITIONER

NOTE: See “Electronic Thermostat” for instructions on turning the air conditioner on and changing the thermostat settings.

The central air conditioner is located behind the louvered body panel on the right (passenger) side of the coach. (See page 0-4.) The panel can be opened for maintenance and periodic service. (See “Condenser Coils”) The cooled air is forced through ducts in the ceiling of the coach. Inside air returns to the air conditioner through a filter system beneath the rear bed. (See “Air Conditioner Filters”.)

Air Conditioner Filter

The disposable furnace type filter is located in a slide-in bracket inside the passenger side of the rear bed cabinet. The filter must be inspected and replaced periodically so the air conditioner will operate efficiently.

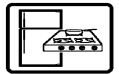

Condenser Coils

The condenser is located behind the louvered body panel on the right side of the coach. The condenser is the large, black, rectangular area that looks like a car radiator. The panel is hinged at the top edge to allow opening for periodic cleaning or service. Remove the screws under the lower edge of the panel and swing it upward for access to the condenser.

Periodically sweep debris carefully from the fins of the condenser. Rinse dust off with clean water. The condenser coils must be clean and free of dust, debris and insect particles, etc., for the air conditioner to cool efficiently.

To Replace the A/C Filter:

- Lift the foot of the rear bed mattress board, which is hinged near the head of the mattress. It is supported by gas props while open.
- Slide the filter out of the bracket assembly at the passenger side of the cabinet.
- Slide the new filter into the bracket, being careful to observe airflow markings on the edge of the filter.

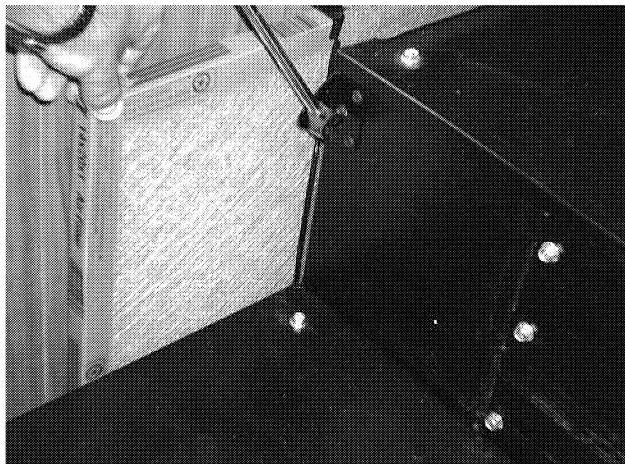

A/C Filter Size: 14" x 20" x 1"

NOTE: Do not block the filter in any way, such as by setting packages or newspapers, etc., on top of it. There must be free air flow for the air conditioner to operate efficiently.

Further Information

See the air conditioner manufacturer's operating instructions supplied in your Owners Info-Case. They contain detailed operating instructions, special precautions and basic troubleshooting.



TV ANTENNA

The TV antenna on your motor home can be easily raised, rotated a full 360° and lowered from inside the vehicle by simply turning a crank or rotating knob. A built-in signal amplifier designed to strengthen signals, is controlled by a power switch built into the TV jack assembly.

The signal amplifier is housed inside the antenna with the circuit board connected directly to the antenna elements. Power to operate the amplifier (12-volt DC) is supplied through the download cable which also carries the TV signals to the TV set. The power supply separates the 12-volt DC from the TV signals and provides a place for attaching the TV set and the 12-volt power source.

Operation

Raising Antenna - Turn elevating crank clockwise in "UP" direction about 13 turns or until some resistance to turning is noted. Antenna is now in operating position. Turn amplifier power switch "ON" to receive TV signal.

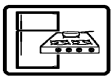

WARNING

Never allow the antenna to touch electrical power lines or any other electrical wires.

Rotating Antenna - Make sure antenna is in the “UP” position. Pull down on rotating knob until it disengages ceiling plate and rotate for best picture and sound on TV set.



Lowering Antenna to Travel Position - Rotate antenna until pointer on rotating knob aligns with pointer on ceiling plate.

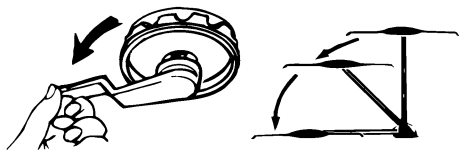

CAUTION

Never leave the antenna partially raised or partially lowered. This can damage the crank mechanism gears. Always raise the antenna straight up or lower it completely into the travel position.

Turn elevating crank (counterclockwise) in “DOWN” direction until resistance is noted. Antenna is now locked in travel position. Turn amplifier power switch “OFF”.

Count the number of turns needed to crank the antenna down to the roof of the unit (normally about 13). Mark the final position of the crank

handle on the ceiling or the directional knob for reference. Also mark the number of turns needed. Use the mark and number as a reference whenever you lower the antenna.

CAUTION

Always align directional handle to “DOWN” position before lowering.

ANTENNA SIGNAL AMPLIFIER

To operate amplifier, turn on power switch.

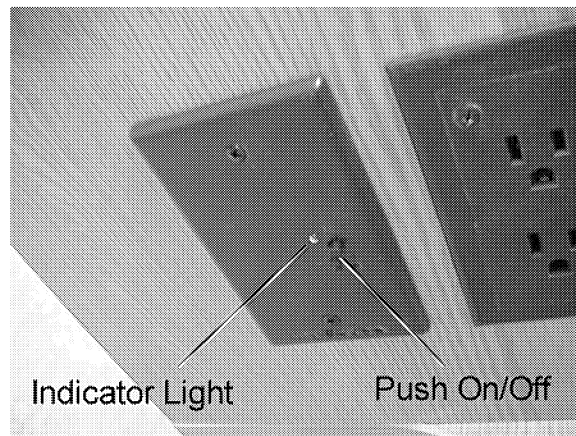

Antenna Signal Amplifier (Typical)

The TV jack plates are mounted in various locations throughout the coach. Some of these wall plates are not readily visible and may be in one of the following locations.

- In front overhead cabinet.
- In the optional entertainment center on the outside of the coach.
- Behind the optional rear bedroom TV.

Checking Amplifier Performance

The TV signals available to an RV are entirely dependent on its location in relation to the transmitter. Signals may vary from strong to no usable signal at all. We recommend that the TV system be checked out in an area known to have good TV reception.

To check the antenna amplifier, raise the antenna, select a TV channel and rotate the antenna for best picture. Then turn off the amplifier power switch. If the antenna amplifier is working properly, the TV picture will now be degraded

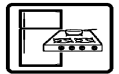

(snowy). When you turn the switch back on, the picture should again be sharp.



DIGITAL SATELLITE TELEVISION SYSTEM - Optional

The Digital Satellite Television System allows you to receive TV programs directly from satellite to your coach. The programs are transmitted in digital format so the quality is equal to laser disc or CD.

See your **Winegard RV Digital Satellite Antenna System Owner's Manual** for instructions about aiming the satellite antenna dish. The coach must be level before attempting to aim the antenna dish.

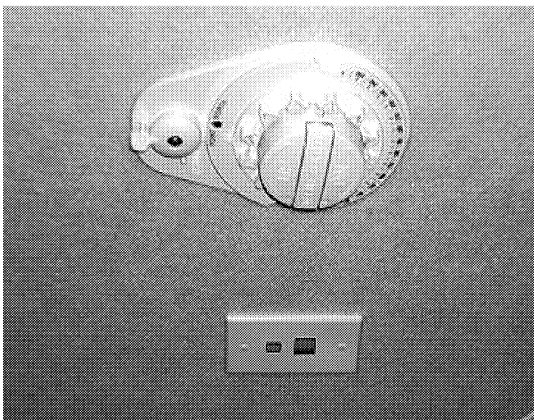

Digital Satellite Dish Control located on ceiling

We recommend that you **read** the satellite dish manual **thoroughly** to understand the system completely before attempting any setups or adjustments.



VIDEO SELECTOR SYSTEM

The video selector system allows you to switch the antenna, cable TV, satellite TV system or VCR signal to any TV set location in the coach.

This means one person can watch a ball game coming in on the roof antenna on the bedroom TV while another person watches a satellite or cable TV program or a video tape on the VCR on the front TV. Also, two people can watch different programs on the two TV's while taping a third program on the VCR.



TV/Radio Speaker Switch

Video Selector

Components

Each component has a set of buttons that lets you select which source you want to get the picture signal from, whether cable TV, roof antenna, digital satellite dish, VCR or whatever equipment you have connected to the AUX input. You will notice the VCR button group has no VCR button. That's because it wouldn't work for the VCR to get a picture signal from itself.

There are three component groups:

- FRONT TV
- VCR (in Video Center)
- TV2 (in Bedroom or Rear of Coach)

Selections (Signal Input):

Each button in a component group lets you select the source you want to draw the picture signal from, such as cable TV, VCR, the roof antenna, or satellite dish antenna. Press the corresponding button to connect to the desired signal source.

- AUX = Press to connect to a video component which you may have installed later, such as a Digital VideoDisc (DVD) player.

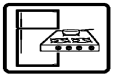

SECTION 8
APPLIANCES & INTERIOR FEATURES

Horizon

- SAT = Press to connect to the Digital Satellite System (dish antenna).
- ANT = Connects to the roof antenna.
- VCR = Connects selected TV to the VCR.
- CABLE = Connects to a local cable TV system hookup if you have connected one to your coach.

Signal Inputs:

ANT - Press to connect selected TV or VCR to the roof antenna.

AUX - Press to connect selected TV or VCR to cable TV input or Satellite TV system.

VCR - Press to connect selected TV to the video-cassette recorder/player.

The cable and phone lines can be routed through the hatch in the bottom of the compartment so the door can remain shut while connected.

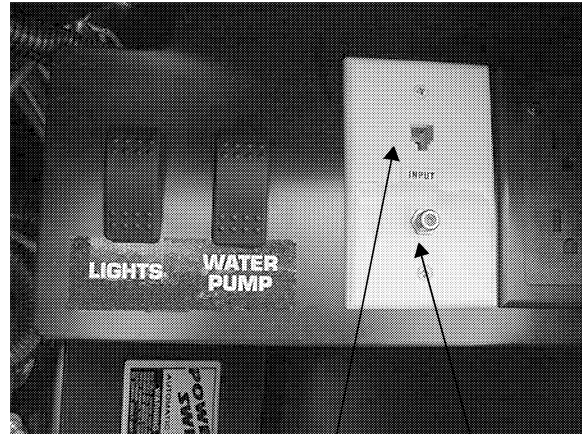

Phone-Hookup

Cable TV Hookup

EXTERIOR ENTERTAINMENT CENTER

The exterior entertainment center contains a stereo radio/cassette player and convenient TV hook-ups for your outside listening or viewing pleasure.

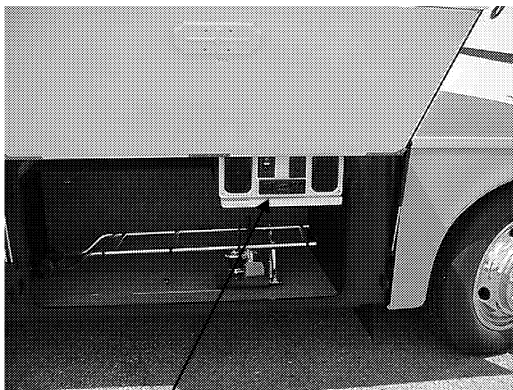

Entertainment Center
(In right front cargo compartment)

Front Phone Jack: On rear facing end of the passenger sidewall armrest just behind the copilot seat.

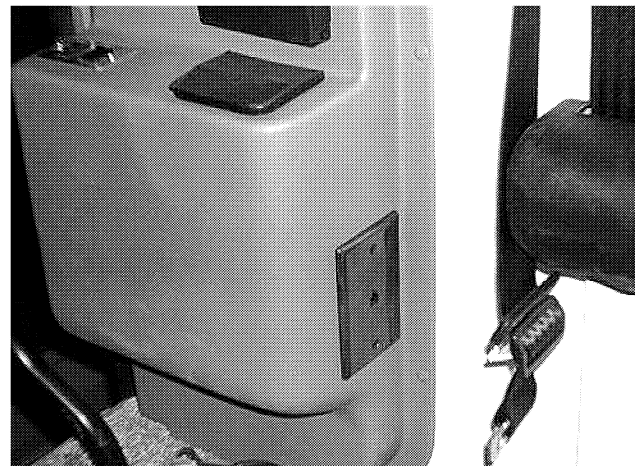

Front Phone Jack: On rear facing end of the passenger sidewall armrest just behind the copilot seat.

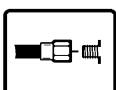

CABLE TV AND PHONE HOOK-UPS (Input)

The cable television and telephone input connectors are located in the shoreline compartment.

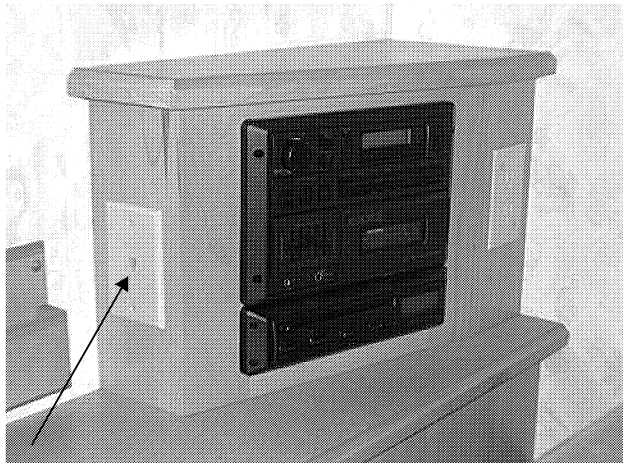
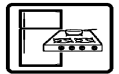

Rear Phone Jack: In the bedroom, near the radio on the nightstand.

BEDROOM RADIO - Optional

The bedroom may be optionally equipped with a built-in stereo radio system in the left rear nightstand cabinet. This radio features AM/FM stereo radio with electronic seek/scan tuning and a full featured alarm clock mode. It may also be equipped with either an auto-reverse cassette player or a CD player.

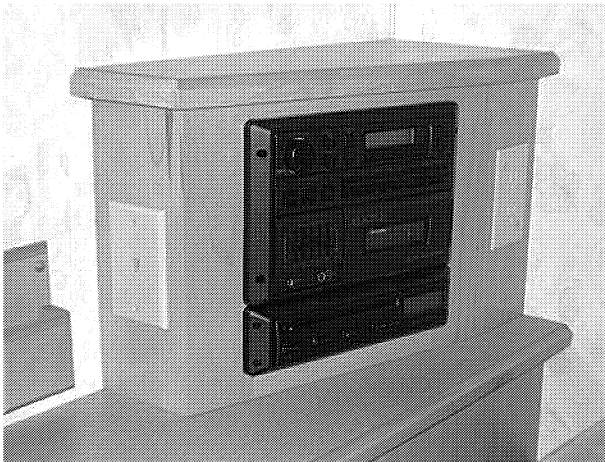

See the Audiovox operator guide on your Owner InfoCase for full operating instructions by the manufacturer.

TABLE AND CHAIRS

The dinette table can be expanded with a leaf when needed. The pull-out leaf is concealed in a pocket beneath the sidewall end of the table.

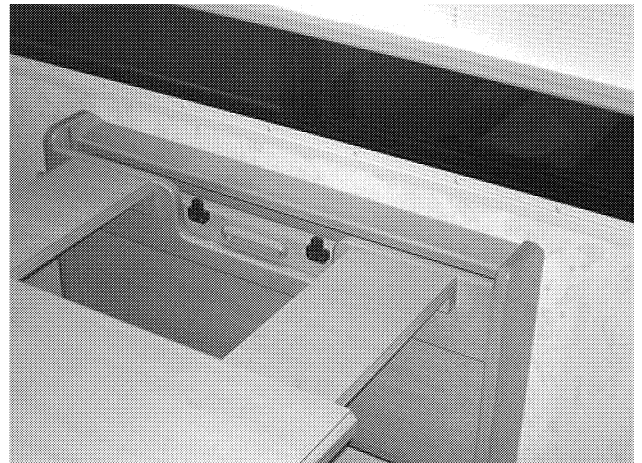

Grasp the end of the table firmly and pull away from the wall, exposing the leaf.

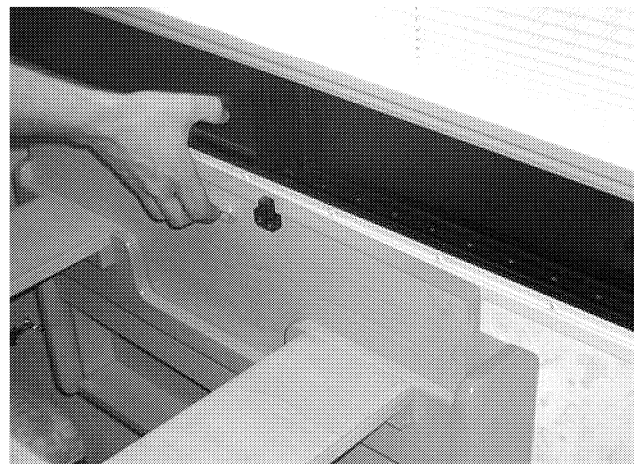

Pull the leaf upward out of the pocket using the handle provided.

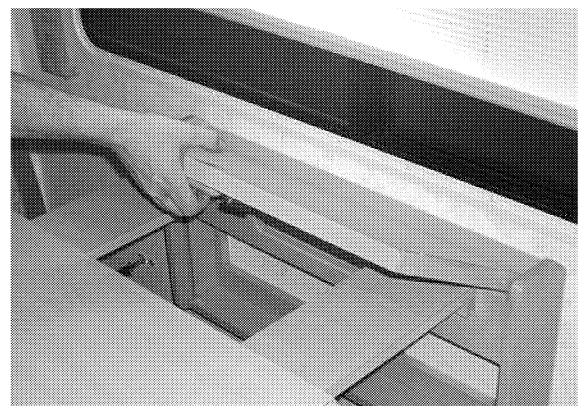

Lower the leaf into position and slide the table top toward the wall.

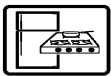

Dinette Chairs

The dinette chairs are free-standing to allow greater freedom of movement than typical booth style dinettes or pedestal seats. Folding dinette chairs are also provided for additional seating when needed. The folding chairs are typically stored in the bedroom wardrobe or under the bed.

Before driving, always stow folding chairs beneath bed and secure dinette chairs with retainer strap provided as shown.

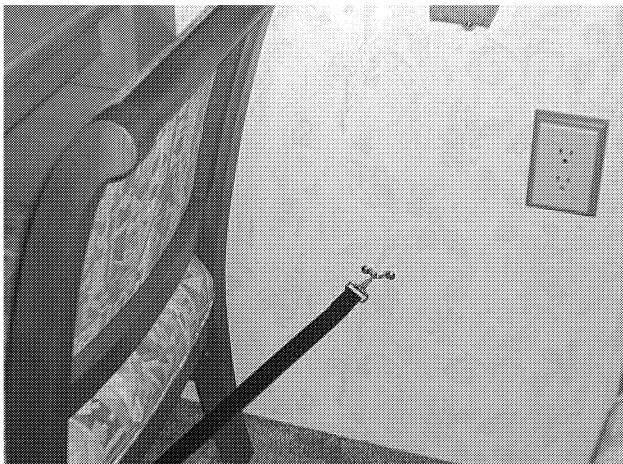

WARNING
Be sure all loose items are secured or stored properly while the vehicle is in motion. Possible overlooked items such as canned goods or small appliances on the countertop, cooking pans on the range, or free-standing furniture items can become dangerous projectiles during a sudden stop.



Rest Easy™ Multi-Position Lounge - Optional (If equipped)



To Recline: Press the switch on the front of the armrest. Press ‘down’ to recline; ‘up’ to return upright.

CAUTION
Do not recline the lounge completely flat unless the footrest section is extended.

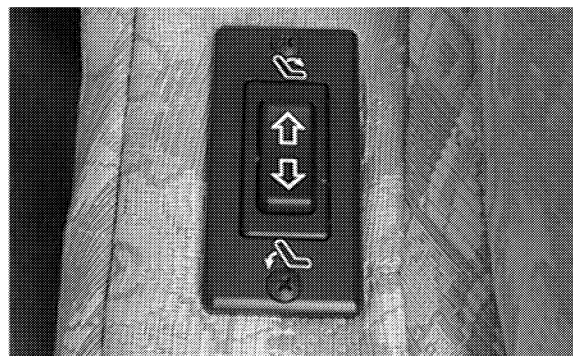

To Extend Pull-Out Footrest Section:
Squeeze latch behind opening at top of lounge face panel and pull footrest trundle section out until it locks in the fully extended position.

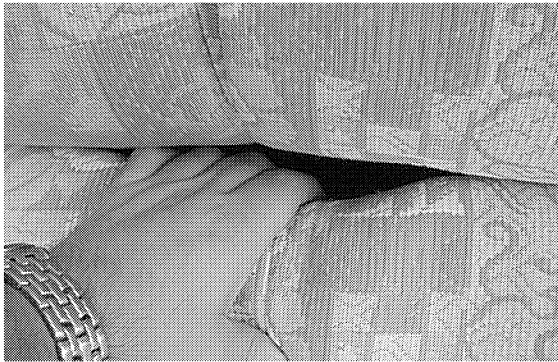
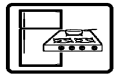

Lift footrest up and away from lounge until it is raised into position.



The gap between the footrest and seat provides ample room to enter and exit the lounge. If desired, however, the footrest can be unlatched and pushed against the lounge seat. The footrest 'drawer' will latch when pulled out completely and must be unlatched to push back in when stowing the footrest.



Tip for "power users": If you have the footrest section unlatched and positioned against the seat cushion, it will move out with the lounge when you press the recline switch. When you return to upright position, you can hook your heels over the front edge of the footrest section and pull it back with you. Then, when you want to get up, simply push the footrest section forward with your feet to provide a gap for you to exit.

To Convert to Bed: Extend footrest section and push together with lounge seat cushion, then press recline button until entire lounge lies flat. Reverse steps to revert to lounge.



CAUTION

To not recline the lounge completely flat unless the footrest trundle section is extended. Do not occupy the lounge when elevating the seatback from the flat bed position to upright lounge position. If house battery voltage is low, the mechanism may require assistance by lifting the seatback while returning upright from flat bed position.

WARNING

To avoid injury to young children, do not allow them to operate the sofa, or to play within the sofa or near the operating mechanism.

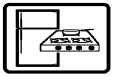

SWIVEL GLIDER LOUNGE CHAIR

This chair is not equipped with a seat belt and is not intended for seating while the coach is in motion. The chair has a glide-lock mechanism to prevent chair movement while the coach is moving. The glide lock is located behind the seat skirt on the rear side of the seat base mechanism.

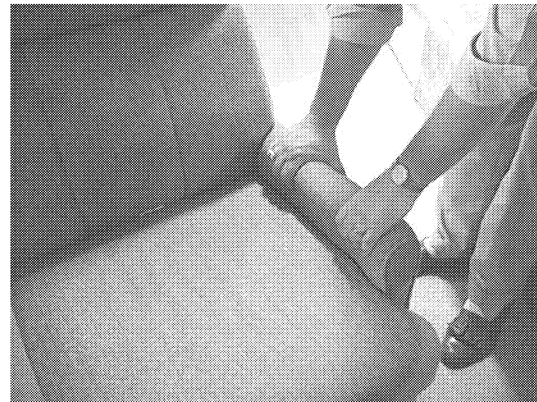
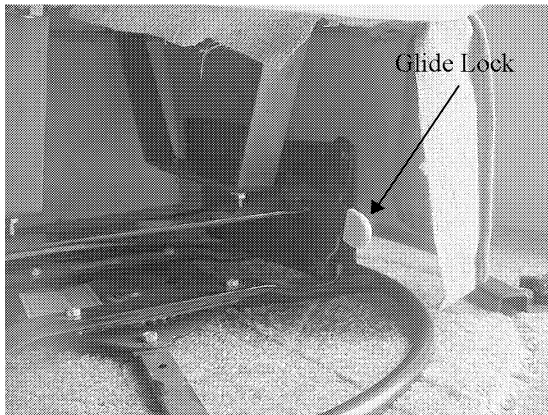
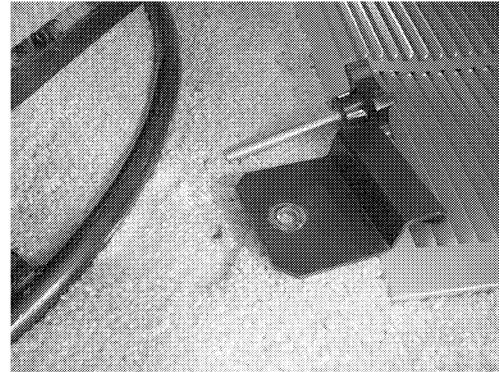

Hoop Chair Mount

The hoop base of lounge swivel glider is mounted to the floor with a clamp as shown.

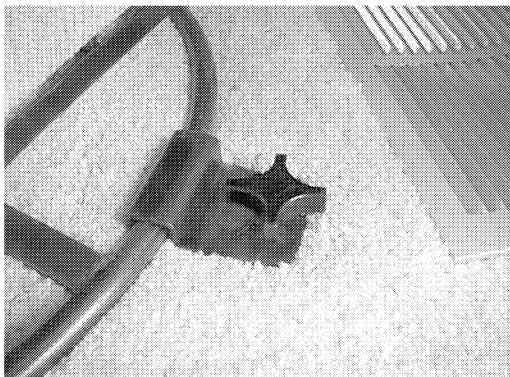

CAUTION
The chair must be clamped back into place and the glide mechanism locked before driving the coach.

The clamp knob can be unscrewed and removed to allow you to position the chair as you desire in the living area of the coach.

BANQUETTE SOFA



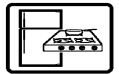

The center backrest cushion is also a flip-down table with drink holders.



FRESH WATER TOILET

The fresh water toilet in your motor home is very similar to the household type, except that it is designed to use only a small amount of water per flush. It uses a high velocity jet of water, producing a swirl effect, to efficiently cleanse the bowl. And since each flush uses fresh water, no special chemicals are required other than a deodorizing agent, if necessary.

1. To add water to the toilet before using, lift the flush lever until the desired water level is reached. Generally, more water is required only when flushing solids.

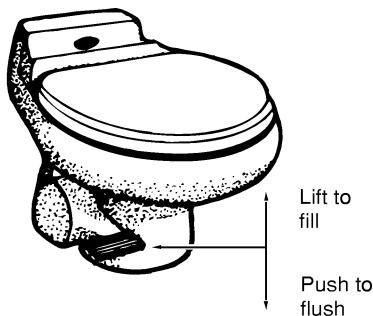

2. To flush the toilet, push the lever all the way down until sewage leaves the toilet and bowl is rinsed clean.
3. Release the flush lever. A small amount of water should remain in the bowl.

Please refer to the manufacturer's information supplied with the toilet for further operating and maintenance instructions.

Important "Don'ts"

- Don't use facial tissue or regular toilet tissue in the RV toilet. These will not disintegrate sufficiently and will often cling to the sides of the holding tank. Toilet tissue made specifically for use in RV toilets and holding tanks is available at most RV supply centers.

- Don't dispose of sanitary napkins or other non-dissolving items in the toilet.
- Don't put automotive antifreeze or caustic chemicals, such as laundry bleach or heavy detergents into the toilet or holding tank. These products may damage plastic or rubber parts in the system.

Cleaning the Toilet

The toilet should be cleaned regularly for maximum sanitation and operating efficiency. If an odor is apparent from the toilet:

1. Clean the toilet bowl with a mild bathroom cleaner. Do not allow cleaners to set in the bowl for long periods of time to avoid damaging the seals. Do not use caustic or abrasive cleaners in the toilet.
2. Dump and rinse holding tank.
3. Add odor control chemical in amount specified after cleaning and every few days during use.
4. Remove the water line from the base of the toilet and clean the screen.
5. If the flush valve becomes stiff after extended use, it may be lubricated with a silicone spray. Turn the water pump off and operate flush pedal to drain water from the toilet bowl. Spray silicone lubricant onto flush valve inside bowl and operate flush pedal a few times to ensure free operation.

See instructions in Section 10 to prepare the toilet for storage in freezing conditions.

POWER ROOF VENT - Bath Area

The power vent in the bathroom ceiling is controlled by switches on the bathroom wall. The FAN switch controls the single speed exhaust fan.

POWER ROOF VENT - Galley Area - Optional

The power roof vent in the galley ceiling has a 3-speed turbine fan and a power dome.

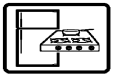

The fan shroud on the ceiling has a fan power switch that lets you turn the fan off if you want just the vent dome raised with no fan running. The fan speed switch allows you to adjust the amount of circulation you need at any time.

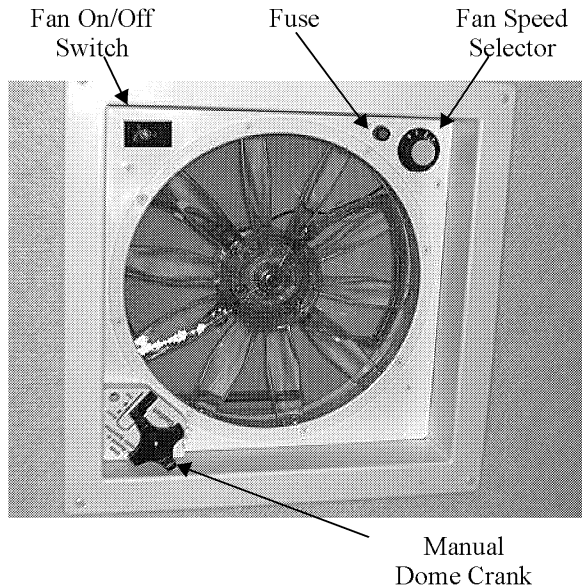

Power Ventilator

SLIDER WINDOWS

Swing the latch handle straight out from the window. Grasp the sliding window edge frame and slide the window to the side. Be sure the latch is open before trying to slide the window closed.

Vertical slider windows have spring-loaded catches on both sides of the window that pop out to hold the window in its fully raised position. Press the catches outward toward the frames while lowering the window.

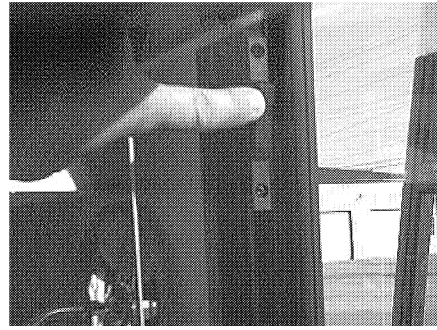

Vertical Window Catches



CAUTION

Sealants must be inspected every 6 months and resealed if necessary.

ROOF

The roof is made of Thermo-Panel materials like the walls and floor. It will support the weight of an average adult should it become necessary to repair the roof or roof mounted components. It is not recommended, however, that very large or heavy objects be carried on the roof while the vehicle is in motion. (See page 4-2 for roof loading specifications.) Always have damage to the roof area repaired immediately. Damaged or detached sealant around the vents, air conditioner, body-to-roof seams, etc., should also receive immediate attention. Delaying these repairs may allow water leakage and result in damage to interior ceiling and body panels, upholstery, etc.

UNDERBODY

Buildup of mud and dirt under the body can cause damaging rust on steel parts and can add needless weight to the vehicle. This, in effect, reduces the amount of cargo you can carry and remain with GVWR and GAWR limits.

Corrosive materials, such as those used for ice and snow removal and dust control, also accumulate on the underside of a vehicle. These materials should be removed by flushing the underbody regularly with water, especially areas where mud and other foreign materials collect.

EXTERIOR

The exterior surface of your motor home has an automotive finish. Frequent washing and thorough cleaning is recommended to prevent damage to the vehicle finish after exposure to damaging salts, calcium chloride, road tar, tree sap, insects and other foreign material. Never wash the vehicle in direct sunlight, while the vehicle surface is hot, or using hot water.

Do not use strong soaps or detergents for washing the motor home. Always use a mild soap in warm water, a commercially prepared product for cleaning automotive finishes or your local car wash. Be careful when using pressure-type washers to avoid loosening exterior decals or sealants, etc.

After washing the motor home, carefully inspect caulking around window frames and vents and any other joints that may have separated. Re-caulking, if necessary, is quite simple. Appropriate compounds are sold at Winnebago and Itasca dealers, and the materials are quickly and easily applied. Also, inspect weather seals around door, etc., and if necessary have a dealer replace them immediately.

CAUTION

Never use a strong solvent such as lacquer thinner, or harsh abrasives on painted surfaces.

It is recommended that a coat of automotive wax be applied to the surface occasionally to provide added protection against harmful deposits coming in contact with the paint.

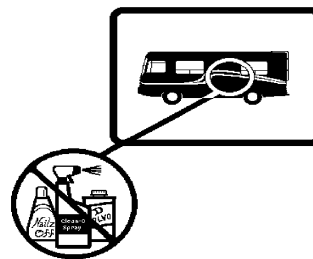

Care of Stripes and Decals

The pressure-sensitive decals on your coach require very little maintenance.

They should be treated like any painted surface on your vehicle. Here are a few helpful hints on caring for decals:

- Wash decals with plain soap and water or any retail car wash soap. Always rinse thoroughly.
- Keep high-pressure wash nozzles at least 1 1/2 feet from edge of decals. High pressure water spray may cause edge lifting of decals.



- Test any cleaning solution on a small section of decal before using.
- Do Not use any aromatic solvents such as acetone, MEK, toluene, xylene, etc., on decals. Any solvent including alcohol may soften or smear colors.
- Do Not use lacquer thinner or paint on decals. Do Not overcoat decals with clear paint.
- Do Not let gasoline or other fuels drip and stay on decals for any length of time. Rinse immediately.

home is parked for an extended period of time.

WARNING

When cleaning upholstery and fabric, do not use lacquer thinner, nail polish remover, laundry soaps, or bleach. Never use carbon tetrachloride, gasoline, or naphtha for any cleaning purpose. These materials may cause damage to the material being cleaned and most are highly flammable.

COMPARTMENT DOORS

Apply powdered graphite lubricant to compartment door latches periodically as necessary to keep latches operating smoothly.

If rubber door seals should become sticky, making the door hard to open, apply a rubber protectant such as 303™, Armor-All™, Son-of-a-Gun™, etc.

UPHOLSTERY, CARPET AND DRAPERIES

We recommend a weekly routine of vacuuming all fabrics and carpet throughout the motor home to prevent an accumulation of dirt which can detract from the appearance and shorten the life of carpet and fabrics.

Upholstery

Some fabrics used in this motor home may contain fire retardant and lightfastness additives which can be damaged by use of improper cleaning products. Some water-based household cleaning products are not formulated for use on fabrics and may cause excessive shrinkage or fading. Always test any cleaning product on a hidden area of fabric before using on visible areas. For best results, fabric cleaning should be referred to a professional carpet and upholstery cleaner.

NOTE: To minimize fading of upholstery, carpets and other interior fabrics caused by excessive sunlight, the drapes, blinds or shades should be closed when the motor

Spots and Stains

Spots or stains should be treated as soon as possible before they “set in” to avoid permanent damage. Always start from the outside of a spot or stain and work inward to avoid spreading it. Use a clean cloth or sponge and turn frequently to an unused area of the cloth or sponge as you clean.

Some stains or soils, such as lipstick, ink, grease or mustard, are extremely difficult or impossible to remove completely and should receive immediate attention. Consult a professional carpet and upholstery cleaner for assistance.

Ultraleather HP™ Leather-Look Upholstery (Optional)

The optional leather look seating is upholstered with Ultraleather HP™ synthetic leather fabric material. This new material has the luxurious look and feel of the finest European calfskin, yet has the durability and resistance to soils and stains of vinyl fabrics. It is also tougher than real calfskin and has superior resistance to punctures, snags and tears.

For most soils and stains the fabric manufacturer recommends spot treatment with a solution of water and Tide™ brand laundry detergent or equivalent. More stubborn stains may be treated with a water-based multipurpose cleaner/degreaser such as Simple Green™ or equivalent. Solvent cleaners such as nail polish remover or other aromatic solvents are not recommended.



Care Instructions

- ◆ Spot clean with mild soap and water.
- ◆ Air dry, or dry quickly with hair dryer on warm setting.
- ◆ For stubborn stains, use mild solvent.

Type of Stain	Detergent/ Water	Cleaner/ Degreaser
Coffee, Tea	◆	
Red Wine, Liquor	◆	
Coke, Soft Drinks	◆	
Milk	◆	
Ketchup	◆	
Steak Sauce, Soy Sauce	◆	
Mayonnaise, Butter	◆	◆
Salad Oil	◆	◆
Chocolate	◆	◆
Cosmetic Foundation	◆	◆
Lipstick	◆	◆
Face Cream	◆	◆
Suntan Oil/Lotion	◆	◆
Shoe Polish	◆	◆
Urine	◆	◆
Machine Oil		◆

Spots and Stains

Spots or stains should be treated as soon as possible before they “set in” to avoid permanent damage. Always start from the outside of a spot or stain and work inward to avoid spreading it. Use a clean cloth or sponge and turn frequently to an unused area of the cloth or sponge as you clean.

Some stains or soils, such as lipstick, ink, grease or mustard, are extremely difficult or impossible to remove completely and should receive immediate attention. Consult a professional carpet and upholstery cleaner for assistance.

Vinyl Fabrics

Vinyl should be cleaned with a soft, damp cloth, and a mild detergent only. Do not use solvents. Solvents may damage the surface of the vinyl.

Draperies, Curtains and Bedspreads

These items may be woven from a variety of fabrics. We recommend that these be professionally dry cleaned only. A five percent shrinkage may occur when you have these items dry cleaned.

CABINETRY

Your cabinets are made of high quality hardwoods. Clean and beautify using a soft cloth and a good quality lemon oil wood finish cleaning product.

NOTE: Cabinetry and furniture items throughout this motor home are constructed either partially or completely of real hardwoods. Because of natural variations in woodgrain density, slight differences in stain hue may exist between one item and another. This is the distinctive character and beauty of real wood.

Decorative Cabinet Mirrors and Windows

Use a good quality glass cleaner or mild soap and water solution. It is best to use a spray bottle to apply a light mist rather than saturating the surface. WIPE DRY IMMEDIATELY. DO NOT ALLOW GLASS TO REMAIN WETTED FOR LONGER THAN A FEW SECONDS. Prolonged moisture can cause the applique coating to lift from the surface of the glass.

Do not use sharp objects to scrape debris such as fly specks etc. Sharp objects can chip or lift the applique coating.

TABLES AND COUNTERTOP SURFACES

The tables, countertop and work surfaces are made of beautiful and durable solid surface material.

- Wipe clean with a sponge and soapy water or ammonia-based cleaner.
- Stubborn stains may be removed using a 3M Scotch-Brite™ or equivalent type scouring pad.



- Towel dry to eliminate water spotting.
- Disinfect by wiping with 50/50 mixture of water and household bleach. Rinse with clean water.
- See the countertop manufacturer's Care & Maintenance booklet in your operations manual binder for further information.

VINYL WALLBOARD

Decorative vinyl covered wallboards may be cleaned with a mild soap and water solution. Do not use solvents or abrasive cleaning products.

RANGE AND REFRIGERATOR

For care and appearance maintenance of the range and refrigerator, refer to the operation and maintenance manual for each of the individual appliances included in your Owners InfoCase.



BATHROOM

The tub and shower walls in the bathroom should be cleaned with a mild soap and water solution, or (to obtain maximum luster) use a good quality wax cleaner. Do not use an abrasive cleaner on the shower walls and tub. If the shower has a glass door, it is extremely important that abrasives not be used. Solvents and aromatic spirits that contain a petroleum base or additive should also not be used. These products can cause a reaction with the glass that results in visible deterioration marks. Use only a good quality glass cleaner or mild detergent and water solution with a soft cloth to clean glass surfaces.

The bathroom lavatory is made of a plastic material and should be cleaned with a mild soap and water solution. Abrasive cleaners or harsh detergents should not be used. See "Tables and Countertop Surfaces" for more information.

For instructions on the care of your fresh water toilet, refer to the information in your Owners InfoCase.



DOORS AND WINDOWS

Windows may be periodically cleaned with a good quality glass cleaner or mild soap solution using a soft cloth. Use care when removing ice or frost from the windows. Always use a plastic ice scraper, never one made of metal. Use care when removing ice from the mirrors to protect the reflective surfaces.

Door locks and hinges should be lubricated periodically with powdered graphite to ensure trouble-free operation and to protect against freeze-up.

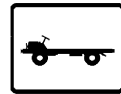

VEHICLE MAINTENANCE

(See also Safety Precautions, Section 1 of this manual).



CHASSIS SERVICE & MAINTENANCE

Consult the appropriate sections in your chassis operating guide for specific information regarding operating safety, service recommendations and maintenance schedules for the chassis section of your motor home.

REAR ENGINE GRILLE

The diesel engine is located behind the grille at the back of the vehicle.

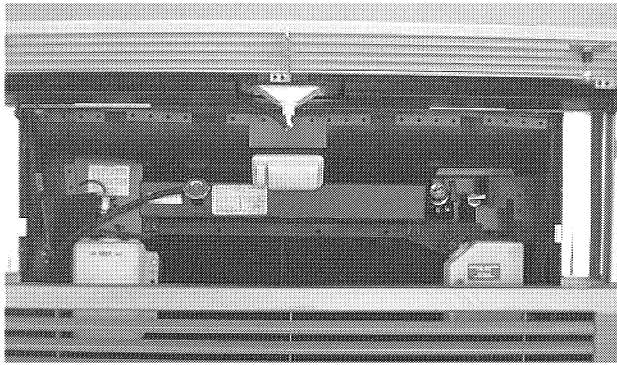

With the service panel open, you can access the following service points:

- Engine Oil Dipstick
- Engine Oil Fill Cap
- Power Steering Reservoir
- Radiator Cap
- Engine Coolant Overflow Bottle
- Transmission Dipstick/Fill Tube
- Air Filter Restriction Indicator

Unlock the service panel and swing it upward.

ENGINE TOP COVER

The engine top cover is located beneath the rear bed. This cover is only removed for replacement of engine parts or if a complete view of the engine is needed for inspection. To do this, remove the mattress from the bed and lift the hinged bed board upward. Support the bed board with a suitable prop rod while accessing engine.

Routine engine inspection can be performed (with protective clothing) under the left rear side of the vehicle, between the luggage compartment and engine exhaust muffler.

FUEL/WATER SEPARATOR

Diesel fuel often contains small quantities of water which can damage the engine if not filtered out. The fuel/water separator traps this water and prevents it from reaching the engine. The harmful water deposits must be drained from the separator canister during normal periodic service and maintenance to keep the fuel filtration system working effectively.

The fuel/water separator is located in the rear engine compartment. Open the grille and look straight down inside the opening.

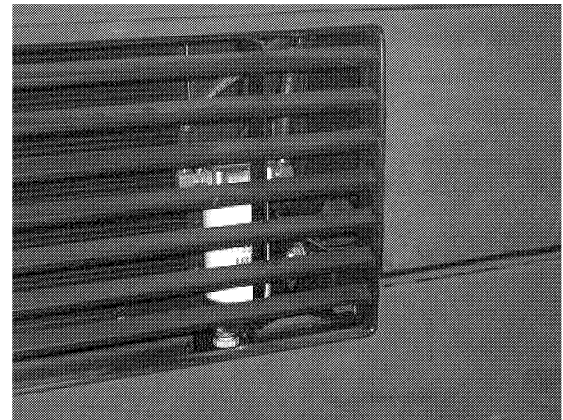

Place an appropriate container beneath the outlet and screw the water release valve open several turns. Drain any water deposits from the canister until clean diesel fuel flows from the valve. Close valve by hand. Do not over tighten.

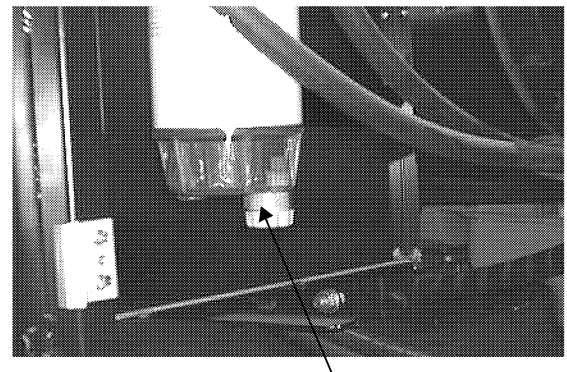

Fuel/Water Drain Valve

Dispose of the drained liquid in an environmentally responsible manner, such as taking to a waste oil disposal center.



ENGINE COOLING SYSTEM

Refer to your Freightliner chassis operating manual and diesel engine manual for information and precautions on filling, servicing and checking the fluid level.



CAUTION

When refilling the coolant system, be sure to allow for additional coolant capacity of the automotive heater and its supply and return hoses.



TIRES

Low air pressure results in tire overloading and abnormal wear and also affects handling and fuel economy. Obtain proper inflation pressures from your chassis operating guide or tire manufacturer.

See the Vehicle Certification Label affixed to the wall near the driver's seat for tire information.

WARNING

Make sure all replacement tires are of the same size and ply rating as those installed as original equipment.

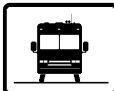

SUSPENSION ALIGNMENT AND TIRE BALANCE

The front suspension and steering system of this vehicle was factory aligned using highly accurate equipment prior to delivery to the dealership. However, we recommend that alignment be checked and adjusted, if necessary, after you have fully loaded the motor home according to your personal needs. Thereafter, the alignment should be periodically inspected to help prevent uneven tire wear.

Any excessive or abnormal tire wear may indicate worn or misaligned suspension or steering, unbalanced tire or other tire/suspension problem.

Alignment can be affected by worn steering/suspension parts or by incidents which happen during driving, such as hitting a curb, pothole or

railroad track, etc. Improper alignment can cause tires to roll at an angle and wear unevenly. It may also cause the vehicle to "pull" to the right or left. Have your dealer inspect your vehicle's suspension and steering components periodically for misalignment or wear.

Out-of-balance tires will not roll smoothly and can lead to annoying vibrations and uneven tread wear such as cupping and flat spots. Tires may need to be balanced if uneven wear is detected or if ride comfort decreases noticeably.

See your chassis operating guide for further information.



WINDSHIELD WASHERS AND WIPERS

See your chassis operating guide for recommendations, precautions and replacement information on washers and wipers.

Loading the Vehicle

NOTE: Your motor home's load capacity is designated by weight, not by volume, so you cannot necessarily use all available space when loading your motor home. See page 4-1 for more information.



LIGHTS

All exterior lights should be checked for proper operation each time the vehicle is prepared for a trip. Any bulbs which fail to light should be checked and replaced, when necessary, with a new bulb of the same size. A failure of more than one light, such as both taillights not operating, may indicate a burned out fuse. Check fuse and replace with one of the same rating when necessary. If a fuse is not the cause of the problem, the wiring system should be checked immediately by an authorized service center.



The headlight circuit is protected by an auto reset circuit breaker built into the headlight switch. An overload on the breaker will cause the lights to flicker on and off. Headlight wiring should be checked immediately anytime this condition is apparent. Refer to your chassis operating guide for further information.

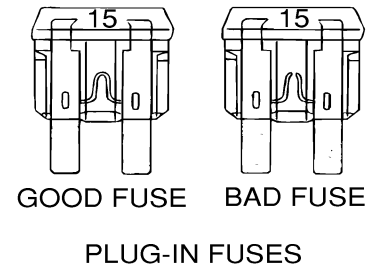

AUTOMOTIVE 12-VOLT FUSES AND CIRCUIT BREAKERS

The automotive fuses and breaker are conveniently located on the automotive fuse/breaker panel behind the “hood” panel as shown below.

The circuit breakers will pop outward if they are tripped. Simply push in to reset.

Always replace plug-in type fuses with those of the same amperage size.

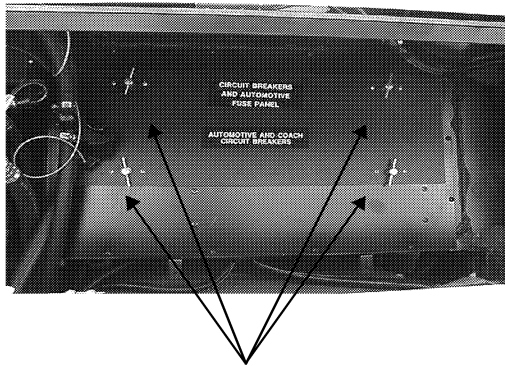

Twist Locks to
Remove Cover

Automotive Fuse/Breaker
(Behind “Hood” Panel)



PREPARING VEHICLE FOR STORAGE

Properly preparing your vehicle for storage will lessen the possibility of damage to your vehicle. Prepare the motor home for vacancy just as you would if you were leaving your house for an extended period:

- Remove all perishables from cabinets and refrigerator
- Prop refrigerator door open.
- Turn off LP gas tank.
- Drain water heater, water tank and holding tank.
- Close shades to protect upholstery from sunlight

When storing your vehicle through the winter, or in cold climates, extra preparations need to be made to protect systems that can be damaged by freezing temperatures.



Cold Weather Storage Procedure (Winterizing)

1. Clean and dump holding tanks by following steps A, B, and C
 - A. Add water to the sewage holding tank by holding the toilet flush lever open with the water pump running. Add water to the waste water holding tanks by opening the kitchen, shower and lavatory faucets. Tanks should be about 1/4 to 1/3 full to rinse properly. Driving to a disposal site will normally loosen and rinse any waste material from the sides of the tank.
 - B. Completely drain the sewage and waste water holding tanks at an approved waste disposal site. Drain the sewage tank first so the following waste water can rinse any waste solids from the dump outlet and sewer hose.
 - C. Close dump valves and refit the dust cap onto the drain outlet.

2. Level the motor home and drain the entire plumbing system as described in the following steps.
3. Then turn on Wash Station Shower Head and lay shower head on ground to drain any water left in shower line. Also place the tip of your finger into the city water inlet and gently press the backflow valve "button" in the center of the inlet to drain any water left in the stub line.

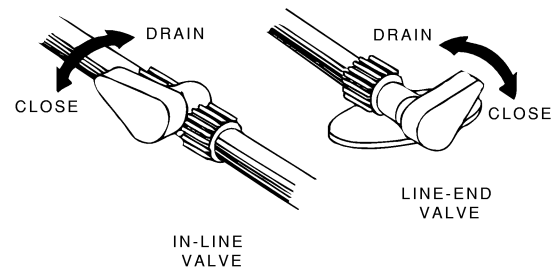

4. Remove and discard the water filter cartridge
 - Raise the valve handle on the filter base.
 - Twist the filter cartridge counterclockwise about 90° and pull it down and out of the filter base.

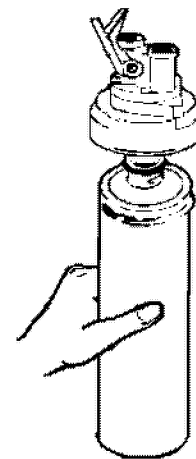

- Place a container beneath the filter base and lower the valve handle to drain any water remaining in the filter lines.



NOTE: If your coach is equipped with the refrigerator ice maker option, the ice maker water lines must also be drained. See "Winterizing the Ice Maker" on page 8-4.



Water Filter Assembly -
Below Galley Sink

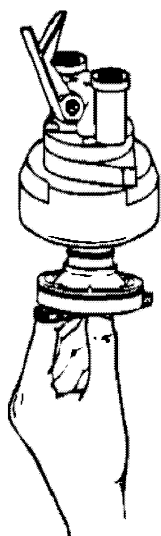

5. Install the antifreeze diverter plug -
 - Raise the valve handle on the filter base.
 - Hold the diverter by the support bar as shown and guide it up into the filter base.
 - Push the diverter up into the head as far as possible and turn it clockwise approximately 90° until it stops.
 - Lower valve handle to lock the diverter plug in place.

NOTE: Before using again the following spring:

- Flush out the system with the diverter in place.
 - After the system has been thoroughly flushed, remove the diverter and store for future use. The diverter plug is intended for winterization only.
 - Install a new water filter cartridge.
 - If your coach is equipped with the refrigerator ice maker option, the ice maker water lines must also be drained. See "Winterizing the Ice Maker" on page 8-4.
6. Turn the Water Pump switch ON to allow it to operate until you are done draining all faucets and toilet.
 7. Open all faucets and shower head valves, including exterior shower.
 8. Operate the toilet flush pedal and hold until water stops flowing in the toilet. Then turn water pump switch OFF.
 9. Turn off the water heater power switch before draining the water heater tank to avoid damage to the heating element. Drain the water heater by removing the plug from the base of the water heater tank, accessible from the outside of the coach. (Requires socket and ratchet.) Also open the Pressure-Temperature relief valve at the top right portion of the tank to prevent air locking in the tank while draining.

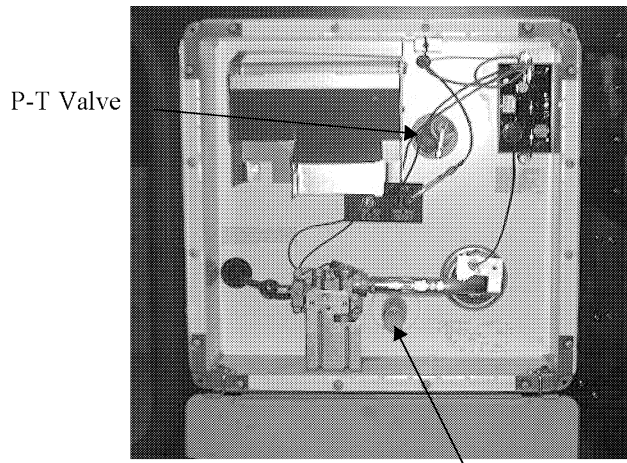

Water Heater Drain Plug

10. After water has stopped draining at all faucets and drain valves, connect a “blow-out” plug to the city water connection on the coach. Then use a hand pump or air compressor regulated to 30 psi or less to force air through the system. (A “blow-out” plug can be purchased at any Winnebago or Itasca dealer. P/N 701705-01-000.)

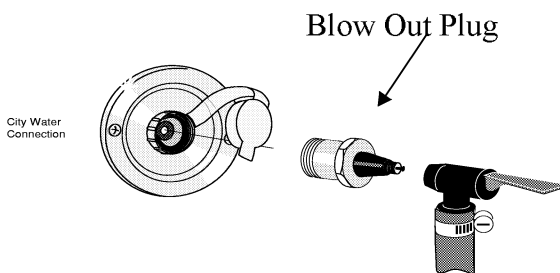

CAUTION
Limit air pressure to 30 psi to avoid damage to pump or water lines.

NOTE: DO NOT burst air into the system. This can damage the water pump. It is better to let air in slowly.

11. Let air flow for five minutes until water is completely drained out of faucets and drain valves. Then close faucets one at a time.
12. Operate and hold toilet flush pedal until water is completely drained from toilet.

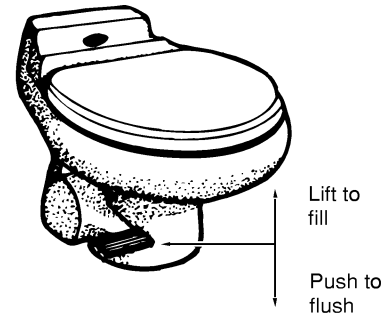

13. Now turn air pressure off and disconnect water purge adapters. Recap the city water connection to avoid contamination by dirt or insects.
14. Close all drain valves and faucets to avoid contamination by dirt or insects. Reinstall water heater drain plug and close P-T relief valve.
15. Pour about one cup of non-toxic RV antifreeze into the kitchen sink drain, bathroom sink drain and shower drain. This prevents any holding tank odors from entering the coach during storage.

WARNING
NEVER use automotive antifreeze/coolant in your RV water system. Auto antifreeze contains ethylene glycol which, if ingested, can cause blindness and can be fatal.

It is not necessary to add antifreeze to the toilet since the flush valve will be closed.

Do not add automotive antifreeze or caustic chemicals such as bleach or laundry detergents into the toilet bowl or holding tanks. Although these products may have a deodorizing effect, they may damage plastic and rubber parts in the system.

NOTE: As an alternative to totally draining the plumbing system, you may winterize tanks and lines by pumping non-toxic RV antifreeze through the system. This product is available from your dealer and from most RV supply stores. Follow directions on the con-



tainer to determine the correct amount to use for your coach.

See "RV ANTIFREEZE WATER LINE WINTERIZATION SYSTEMS" at the end of this section for instructions.

CAUTION

Leave by-pass valve handle in NORMAL FLOW position if draining water and blowing out water lines. Place in BYPASS position ONLY when using antifreeze solution in water lines.

16. Place a bucket beneath the sewage drain valve outlet and re-drain the sewage and waste holding tanks of any clean water that entered during "blow-out" procedure.

Close dump valves to prevent valve shafts from rusting and to prevent entry by rodents and insects. Refit the dust cap onto the drain outlet.

Your drainage and fresh water systems are now totally winterized.

17. Turn off the LP gas tank.
18. Turn the furnace thermostat switch on the bottom of the thermostat to OFF.
19. Remove all foods and items that may cause odors from cabinets and refrigerator.
20. Clean and defrost the refrigerator. Prop the door open slightly to allow any odors to dissipate. Place an open box of baking soda inside the refrigerator to help absorb odors.
21. Turn auxiliary battery (Aux Batt) switch off and disconnect all chassis and auxiliary battery cables.
22. Fully charge all batteries. Batteries must have at least 80% charge to survive freezing temperatures and long periods of non-use.
23. Have the vehicle chassis completely serviced and lubricated. Be sure radiator antifreeze protection level is sufficient for the lowest anticipated temperatures.

24. Wash and wax the coach.
25. Inspect all seams and seals around doors, windows, vents, and any other joints. Replace or repair any that are damaged. Sealing materials and compounds can be purchased from your dealer. Badly damaged weather seals may need to be replaced by your dealer.
26. Close all windows and roof vents. Protect all appliance vent openings from contamination by animals or insects (e.g. bird nests, wasp nests, etc.)
27. Lubricate all door hinges and locks.
28. Clean the interior of the coach. Dirt and stains are more easily removed when fresh.

NOTE: We do not recommend leaving the shore-line plugged in continuously during storage periods because the batteries can lose electrolytic fluids and become damaged from continuous charging without periodic use. We recommend following regular battery inspection and maintenance, especially in cold weather. See "Battery Maintenance" on page 6-10 this section.

RV ANTIFREEZE WATER LINE WINTERIZATION SYSTEMS

Manual Winterization Valve - Standard

Your coach is equipped with a manually operated water line winterization system for your convenience in winterizing fresh water lines.

The system features a diverter valve and draw tube in-line between the tank and water pump, and uses the water pump to draw non-toxic RV water system antifreeze into the water lines. This feature is located near the water pump on in the water center compartment.

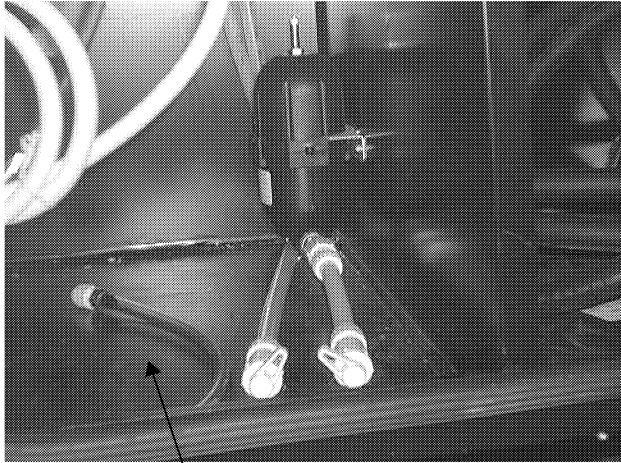

RV Antifreeze
Draw Tube
(in water center or near water pump)

To Fill Lines with RV Water Line Antifreeze:

- Turn water heater by-pass valve to by-pass position.
- Remove and save the protective cap from the end of the draw tube (clear vinyl hose).
- Insert the end of the hose into a container of RV antifreeze solution.
- Turn the valve handles to the winterize positions shown on the valve panel.
- Turn a water pump switch on.
- Open each cold water faucet handle in the coach one at a time until antifreeze solution just begins to flow from the faucet, then close.

When Done Adding RV Antifreeze:

- Turn water pump switch off.
- Turn the diverter valve handle so it points to normal position shown on the panel.
- Replace the protective cap onto the end of the draw tube to keep out insects and debris when not in use.



REMOVAL FROM STORAGE

1. Completely air out the motor home.
2. Have the entire LP gas system checked for leaks.

3. Check window operation.
4. Check cabinet and door hinges. Lubricate with penetrating oil, if necessary.
5. Close all faucets and drain valves that are open. If necessary, reconnect toilet water line and close flush valve.
6. Add a few gallons of water to the fresh water tank and check for leaks especially at junctions. Also make sure all hangers and supports are securely in place. Sanitize the water system as outlined under "Disinfecting the Fresh Water System" in Section 7.
7. Check operation of all faucets to be sure faucet washers have not hardened during storage.
8. Check sealing valve in the toilet for proper operation and lubricate with silicone spray.
9. Add water to the holding tank using the toilet flush pedal. Check to be sure dump valve seals tightly.
10. Check around all appliances for obstructions and ensure that all vent openings are clear.
11. Start refrigerator and check for proper cooling.
12. Clean paneling and counter surfaces and apply a thin coat of wax.
13. Replace batteries if necessary and check out electrical system to make sure all lights and electrical components operate.
14. Check tires for proper cold inflation pressure.
15. After washing accumulated winter grime from the vehicle, it is important to carefully inspect the seams and sealants for separation or cracks that may have appeared around the window frames, vents and any other joints. Re-sealing is quite simple and the material is quickly and easily applied. Appropriate compounds are available from your dealer. Also inspect weather seals around doors, etc., and if necessary, have a dealer replace immediately.

Horizon

INDEX

- A**
- Accumulator Tank, Water System 7-3
 - Air Conditioner, Automotive 2-15
 - Air Conditioner, Central 8-16
 - Air Conditioner Filter 8-16
 - Alarm, LP Gas 1-3
 - Alignment, Front Axle Tire 4-1
 - Alignment, Suspension and Tire Balance 9-6
 - Antenna, CB SWR Adjustment 2-17
 - Antenna Check Light, TV 2-16
 - Antenna, TV 8-17
 - Antenna Signal Amplifier, TV 8-17
 - Antifreeze, RV Winterization Systems 10-4
 - Automatic Winterizing System 10-4
 - Automotive (Starting) Batteries 6-9
 - Auto 12V Fuses & Circuit Breakers 9-7
 - Auxiliary Battery Switch 2-17
 - Aux Start Switch 2-17
 - Auxiliary (House) Batteries 6-9
 - Auxiliary 110-Volt Generator 6-6
- B**
- Bathroom, Care of 9-4
 - Batteries, Chassis (Starting) 6-9
 - Batteries, Auxiliary (House) 6-9
 - Battery Charger, Connecting 3-3
 - Battery Voltage Meter 8-9
 - Battery Information 6-9
 - Battery Maintenance 6-9
 - Battery Switch, Aux 2-17
 - Beds, Converting for use 8-22
 - Before Driving your Vehicle 2-1
 - Before Entering your Vehicle 2-1
 - Block Heater, Diesel Engine 2-3
 - Brake, Engine Exhaust 2-4
 - Brake, Parking 2-3
 - By-Pass Valve, Water Heater 8-13
- C**
- Cabinets 9-3, 9-4
 - Cable TV Hook-Ups 8-19, 8-20
 - Campsite Selection 4-6
 - Capacities*
 - Fuel Tank 2-2
- D**
- Fresh Water Tank 7-1
 - Holding Tanks 7-8
 - LP Gas Tank 5-3
 - Water Heater 8-10
 - Carbon Monoxide Alarm 1-5
 - Carbon Monoxide Warning 1-5
 - CB Radio Wiring 2-18
 - Central Air Conditioner 8-16
 - Chairs, Dinette 8-20
 - Charger Panel, Solar 6-8
 - Charging Section 6-4
 - Chassis Guide (Freightliner) 0-1
 - Chassis Service and Maintenance 9-5
 - Check Light, Antenna 2-16
 - Checklist, Pre-Travel 4-3
 - Child Restraints 2-12
 - Circuit Breakers, 12-Volt 6-8, 9-7
 - Circuit Breakers, 110-Volt 6-4
 - City Water Hook-Up 7-4
 - Coach Leveling System 2-18
 - Cold Weather Storage (Winterizing) 10-1
 - Comfort Controls 2-15
 - Compact Disc (CD) Changer 2-17
 - Compartment Doors, Luggage 2-7
 - Condensation, Humidity and 4-6
 - Connecting a Battery Charger 3-3
 - Connecting the Shoreline 6-1
 - Converter, Electrical Power 6-3
 - Cooling System, Engine 9-6
 - Couch/Bed Conversion 8-22
 - Crank-in, Slideouts Emergency 2-22
 - Cruise Control 2-14
- D**
- Decals and Stripes 9-1
 - Defects, Reporting Safety 0-3
 - Defroster 2-15
 - Deluxe Sound System 2-16
 - Diesel Engine Block Heater 2-3
 - Diesel Engine Manual 0-1
 - Diesel Fuel/Water Separator 9-5
 - Digital Satellite System 8-18
 - Dinette Table & Chairs 8-20
 - Disinfection of Fresh Water Tank 7-3
 - Door Handles and Locks 2-4
 - Doors and Windows, Care of 9-4
 - Drain Valves, Water 7-7
 - Drainage System 7-6

* Capacity chart is also conveniently located on the back of "To The Owner" page inside front cover of this manual.

Draperies, Care of	9-3	Fuel Tank, Filling	2-2
Drinking and Driving	0-2	Fuel/Water Separator (Diesel)	9-5
Driver Seat	2-9	Furnace , LP Gas	8-13
Driving Safety Precautions	1-1		
Dumping Holding Tanks	7-5	G	
E		Gas Alarm, LP	1-3
Effects of Prolonged Occupancy	4-6	Gas Leaks, LP	5-4
Electrical Inverter/Charger	6-3	General Warnings	1-1
Electrical Outlets, 110-volt	6-5	Generator, Auxiliary 110-Volt	6-5
Electrical Safety Precautions	1-4	Generator Hourmeter	6-7
Electrical System, 110-volt AC	6-1	Ground Fault Circuit Interrupter	6-5
Electrical System, 12-volt DC	6-8	H	
Electronic Thermostat	8-13	Hazard Warning Flashers	2-4, 3-1
Emergency Crank-in, Slideouts	2-22	Heat Pump	8-15
Emergency Exits	1-6	Heater, Engine Block	2-3
Energy Management System, PowerLine	6-3	Heater, Automotive	2-15
Engine Access	9-5	Holding Tank Level Indicators	8-8
Engine Block Heater, Diesel	2-3	Holding Tanks, Dumping	7-6
Engine Cooling System	9-6	Hourmeter, Generator	6-7
Engine Exhaust Brake	2-4	Humidity and Condensation	4-6
Engine Overheat	3-3		
Engine Top Cover	9-5	I	
Entertainment Center, Exterior	8-19	Instrument Panel	2-13
Entrance Door Lock and Handle	2-4	Interior Care	9-2, 9-3
Entrance Steps, Electric	2-5	J	
Entrance Stepwell Cover	2-7	Jump Starting	3-2
Equipment, Options and	0-2	K	
Exits, Emergency	1-6	Keys (Key One Lock System)	2-2
Exterior Body Care	9-1	L	
Exterior Entertainment Center	8-19	Leather Upholstery	9-2
Exterior Features	0-5	Leveling, Coach	4-6
Exterior Shower	7-5	Leveling System, Coach	2-18
External (City Water) Connector	7-4	Lights	9-7
External Power Cord (Shoreline)	6-1	Loading, Roof	4-2
F		Loading the Vehicle	4-1
Filling the Fuel Tank	2-2	Locks, Entrance Door	2-4
Filter, Central Air Conditioner	8-16	Locks, Power Door	2-5
Filter, Diesel Fuel/Water	9-5	LP Gas Alarm	1-3
Fire Extinguisher	1-7	LP Gas Furnace	8-13
Flushing Black Water Tank	7-6	LP Gas Leaks	1-3, 5-4
Formaldehyde Warning	1-5	LP Gas Level	8-8
Freightliner Chassis Guide	0-1	LP Gas Pressure Regulator	5-4
Fresh Water Tank	7-1	LP Gas Safety	5-1
Disinfecting	7-3	LP Gas Selection	5-2
Draining	7-6, 7-7	LP Gas Tank, Air in the	5-3
Filling	7-1	LP Gas Tank, Refilling	5-2
Fresh Water Toilet	8-22	LP Gas Tank System	5-2
Front Axle Tire Alignment	4-1	LP Gas, Travel with	5-3
Fuel Selection	2-2		
Fuel Tank Capacity	2-2		

LP Gas, Winter Use of	5-5	Restraints, Child.....	2-11
Luggage Compartment Doors.....	2-7	Roof Loading	4-2
M		Roof Maintenance.....	9-1
Maximum Occupancy	4-2	Roof Vent, Power	8-23
Microwave Oven.....	8-7	Room Extensions, Slideout.....	2-20
Mirrors, Power Electric	2-7	RV Antifreeze Winterization System	10-4
Monitor, Rearview TV.....	2-9	S	
Monitor Panel, One Place	8-7	Safe Use of LP Gas System	5-2
Motor Aid Water Heater	8-12	Safety Defects, Reporting	0-3
Mountain Driving	4-5	Safety Precautions.....	1-1
N		Seat, Driver	2-9
Nighttime Driving.....	4-5	Seat Belts and Child Restraints.....	2-10, 2-11
O		Seats	2-9
Occupancy, Effects of Prolonged	4-6	Selecting Fuel Types, LP	5-2
Occupancy, Maximum.....	4-2	Service Assistance	0-2
OnePlace Systems Monitor Panel.....	8-7	Severe Weather Information	4-4
Options and Equipment	0-2	Sewer Hook-Ups, Using On-Site	7-6
Outlets , 110-Volt	6-5	Shoreline, Connecting the	6-1
Overload Protector, Thermal	6-4	Shower, Exterior.....	7-5
P		Signal Amplifier, TV Antenna.....	8-17
Parking Brake	2-3	Sink, Stainless Steel	9-4
Phone Connections	8-19	Sleeping Facilities.....	8-22
Power Converter	6-3	Slideout Room Extensions.....	2-20
Power Electric Mirrors.....	2-7	Slider Windows.....	8-23
PowerLine Energy Management System.....	6-3	Smoke Alarm	1-7
Power Roof Vent	8-23	Solar Charger Panel	6-8
Power Seat, Driver Six-Way.....	2-9	Sound Systems.....	2-16
Power Step, Entrance	2-5	Speed Control (Cruise).....	2-14
Pre-Travel Checklist	4-3	Spots and Stains	9-2
Preparing Vehicle for Storage	10-1	Start Switch, Aux	2-17
Pressure Regulator, LP Gas	5-4	Starting and Stopping the Engine	2-2
Prolonged Occupancy, Effects of	4-6	Step, Electric Entrance	2-5
Pump Switch, Water	7-2, 8-8	Stepwell Cover.....	2-7
R		Storage, Preparing Vehicle for	10-1
Radio, Bedroom	8-20	Storage, Removal from	10-5
Radio Switch.....	2-16	Stripes and Decals.....	9-1
Radio Wiring, CB	2-18	Suspension Alignment and Tire Balance.....	9-6
Range Top (Cook Top).....	8-6	Switch, Radio	2-16
Range Hood	8-7	SWR Adjustment, CB Antenna	2-17
Rear Engine Access, Diesel.....	9-5	T	
Rearview TV Monitor.....	2-9	Table and Countertop Surfaces.....	9-3
Recovery Towing.....	3-1	Table, Dinette.....	8-20
Refrigerator	8-1	Tank, Fresh Water Filling	7-1
Regulator, LP Gas	5-4	Tank Capacities, Water and Holding.....	7-9
Relief Valve, Water Heater.....	8-11	Telephone Hook-Ups.....	8-19
Removal from Storage	10-5	Thermal Overload Protector	6-4
Reporting Safety Defects.....	0-3	Thermostat, Electronic	8-13
		Tire Balance, Suspension Alignment and	9-6
		Tire Changing.....	3-1
		Tires	9-6

Toilet, Fresh Water	8-22	Windows, Doors and	9-4
Towing, Recovery	3-1	Windows, Emergency Exit	1-6
Trailer or Car Towing	4-2	Windshield Washers and Wipers	9-7
Trailer Wiring Connector	6-11	Windshield Wiper/Washer Switch	2-15
Travel Tips	4-3	Winter Use of LP Gas	5-5
Travel with LP Gas	5-3	Winterizing	10-1
TV Antenna	8-17	Winterization Valve, Manual	10-4
TV & Cable Hook-Ups,	8-19, 8-20	Winterization Systems, RV Antifreeze	10-4
TV Signal Amplifier	8-17	Wiring, CB Radio	2-18
TV Monitor, Rearview	2-9		
U			
Underbody Care	9-1		
Upholstery	9-2		
Using On-Site Sewer Hook-Ups	7-6		
V			
Vehicle Certification Label (VIN)	0-4		
Vehicle Maintenance	9-4		
Vents, Power Roof	8-23		
Video Selector System	8-18		
Vinyl Fabrics	9-3		
Vinyl Wallboard	9-4		
Voltage Meter, Battery	8-9		
W			
Warnings:			
Carbon Monoxide	1-5		
Driving	1-1		
Formaldehyde	1-5		
Fuel & LP Gas	1-2		
LP Gas Leaks	1-3		
LP Gas Alarm	1-3		
Electrical	1-4		
Loading	1-4		
Maintenance	1-4		
Warranty	0-2		
Washer/Dryer	8-9		
Water and Holding Tank Levels	8-8		
Water Drain Valves	7-7, 7-8		
Water Heater	8-10		
Water Heater By-Pass Valve	8-13		
Water Heater Capacity	8-10		
Water Line Drain Valves	7-7		
Water Pump	7-2		
Water Pump Switch	7-2, 8-8		
Water Purifier System	7-4		
Water Tank, Disinfecting	7-3		
Water Tank Filling	7-1		
Weighing Your Loaded Vehicle	4-1		
Windows, Cleaning	9-3		
Windows, Slider	8-23		

**IMPORTANT
SERIAL NUMBERS**

Motor Home (Coach): Year _____ Model _____ Serial _____
Chassis: Make _____ Serial (VIN) _____

Roof Air Conditioner:	Brand _____	Model _____	Serial _____
Furnace:	Brand _____	Model _____	Serial _____
Water Heater:	Brand _____	Model _____	Serial _____
Power Converter:	Brand _____	Model _____	Serial _____
110-Volt Generator:	Brand _____	Model _____	Serial _____
Range	Brand _____	Model _____	Serial _____
Microwave Oven:	Brand _____	Model _____	Serial _____
Refrigerator	Brand _____	Model _____	Serial _____
Television:	Brand _____	Model _____	Serial _____
Video Cassette Player:	Brand _____	Model _____	Serial _____

EMERGENCY INFORMATION

Dealer

Name _____

Address _____

Phone _____

INSURANCE POLICY

Company _____

Policy Number _____

Phone _____

