

“JOIN THE CLUB”

AND BE SOMEONE VERY SPECIAL!

As the proud owner of a Winnebago or Itasca brand motor home, you are eligible to belong to the Winnebago-Itasca Travelers Club (WIT). WIT offers the opportunity to share friendship and fun with people like yourself — special people — for whom travel and adventure have become a way of life ... people who are drawn to the open road and the chance to explore the world around them.

Come along to share the camaraderie and companionship

For many, the best thing about WIT is the goodwill and fellowship that develops among members of this exclusive club. There's something for everybody. Special groups exist within WIT for people with travel-related interests: Amateur Radio Club, the 365 Club (for members who spend 6 months of each year in their unit), Handicapped Club, WIT-LEO (for all present and former law enforcement officers) and Singles Club. Those who seek activity can play bingo, hike, pitch horseshoes and more. Those who wish to relax may just want to sit around the campfire swapping tales.

No matter how frequently you travel, WIT can be of service

Whether you travel one weekend a month or every day of the year, you'll benefit from the many conveniences and services WIT offers: membership directory, monthly club magazine, campground discount card, trip routing, 10% discount at Winnebago Customer Service on parts and catalog sales, opportunities to purchase personal RV insurance, long term convalescence care insurance, and merchandise, WIT premium road service, mail forwarding and more to come!

We'll make all the plans for trips to near and far

As a WIT member, you'll be invited to attend local outings and state rallies. The Grand National Rally is held each year at Forest City, Iowa. For those on the move WIT sponsors a number of caravans and tours each year to exciting places. WIT members travel together in the comfort and convenience of their own motor homes, headed by professional tour directors who handle all the arrangements.

WIT offers Premium Road Service

Fast service is provided from more than 20,000 RV warranty stations nationwide including Canada and Alaska through a toll-free "800" phone service.

Send in your application now and become a member of our exclusive club

Add to the enjoyment of your motor home and your leisure time by joining this friendly, active group. Simply fill out the application form and send it to us with your check or money order, or charge it to your VISA, MasterCard or Discover card. Your name will be added to our list of very special people and you'll begin immediately to reap the benefits of membership in the Winnebago-Itasca Travelers Club.

APPLICATION FOR MEMBERSHIP WINNEBAGO-ITASCA TRAVELERS

P.O. Box 268 Forest City, IA 50436 Phone (515) 582-6874

(PLEASE PRINT)

Name _____ Companion's or
Spouse's name _____

Address _____

City _____ State _____ Zip _____

Telephone: () _____

METHOD OF PAYMENT

Personal check or money order VISA Mastercard Discover

Card No.: _____ Expiration Date: _____

Signature: _____ Date: _____

TYPE OF UNIT:

WIT must have coach serial number (begins with 10, 70 or 80 and has 11 or 12 digits)

- NEW MEMBERSHIP
 Dues of \$30 for 1 year Dues of \$50 for 2 years Dues of \$65 for 3 years
 REINSTATEMENT OF WIT No. _____
 Dues of \$25 for 1 year Dues of \$45 for 2 years Dues of \$60 for 3 years

MEMBERSHIP SPONSORED BY:

Name _____ WIT No. _____



WIT MEMBER BENEFITS

WIT CLUB NEWS

Each member of WIT receives a copy of our magazine. You will find articles about maintaining your coach, rallies and caravans, news of the chapters and clubs, cooking on the road and other interesting activities.

WIT PREMIUM ROAD SERVICE

WIT members may purchase this road service program which provides no limit towing, free emergency message service and more.

UNIQUE MOTOR HOME INSURANCE

WIT members may purchase a very special motor home insurance policy on their motor home that includes, for newer coaches, complete replacement of their coach. Also if you have to be towed, it includes full towing reimbursement. This special policy is available only to WIT members.

FREE TRIP ROUTING SERVICE

WIT's trip routing service provides maps and travel information to help you reach your destination either by the quickest route or most scenic.

MEMBER IDENTIFICATION

WIT provides each member with logos and sets of numbers for easy identification on the road or at WIT functions.

MEMBERSHIP DIRECTORY

WIT publishes a membership directory that is sent to each member. It contains the complete address of each member of the club as well as other helpful information.

YOUTH ACTIVITIES

A full program of activities takes place at each Grand National Rally. Many chapters and club have active youth programs.

CHAPTERS AND CLUB

There are over 250 local chapters and state clubs across the country that welcome you to join and participate in their activities. Also, there are special interest national clubs which invite you to join including full timers, golfers, single motor homers, ham radio, law enforcement officers, and others.

DISCOUNTS

Winnebago Products Inc. Catalog— 10% discount on any item purchased. (\$10.00 minimum order)

WIT Campgrounds— 10% discount at hundreds of enrolled campgrounds.
Winnebago's Customer Service, Forest City, IA and Temple, TX— 10% discount on all parts and accessories.

CARAVANS AND RALLIES

WIT develops and runs over a dozen events a year. These include caravans in Canada, Alaska and the U.S. as well as city rallies in Canada and the U.S.

MAIL FORWARDING

If you are on the road for a lengthy period of time, WIT has a mail forwarding program. You pay only for the actual cost of postage plus a handling charge.

GRAND NATIONAL RALLY

Each year, WIT holds a Grand National Rally in Forest City, Iowa for all WIT members. Name entertainment, a large number of seminars, crafts activities, and other programs are included.

CONVALESCENT CARE INSURANCE

WIT has made arrangements with a national insurer for a program for convalescent care. This optional extra cost program can take all the financial worry out of a possible future stay in a convalescent care facility.

“JOIN THE CLUB”



TO THE OWNER

Congratulations! We welcome you to the exciting world of motor home travel and camping. you will find it convenient and enjoyable to have all the comforts of home and still enjoy the great outdoors wherever you choose to go.

Your motor home has been carefully designed, engineered and manufactured to provide dependability as well as safety. Before sliding into the driver's seat, take a few minutes to become familiar with operations and features. This manual was prepared to aid you in the proper care and operation of the vehicle and equipment. We urge you to read it completely. In addition, spend some time with the dealer when you take delivery to learn all you can about your new motor home.

Your new motor home is covered by a factory warranty against defects in material and workmanship. This warranty should be validated at once and returned to the factory by your dealer.

Throughout this manual, reference is made to the following terms: Important, Caution and Warnings. These terms indicate important information which must be understood and followed. The definitions of these terms are:

IMPORTANT

Indicates a special point of information.

| |
|---|
| CAUTION |
| Indicates a failure to observe can cause damage to equipment. |

| |
|---|
| WARNING |
| Indicates a failure to observe can cause personal injury or death and possible damage to equipment. |

OWNER'S NAME

STREET ADDRESS

CITY AND STATE (OR PROVINCE IN CANADA)

MOTOR HOME SERIAL NUMBER

VEHICLE CHASSIS IDENTIFICATION NO. (VIN)

DATE OF DELIVERY TO FIRST RETAIL PURCHASER

VEHICLE MILEAGE AT TIME OF SUCH DELIVERY

SELLING DEALER NAME AND ADDRESS

TABLE OF CONTENTS

INTRODUCTION

| | |
|--|-----|
| Chassis Operating Guide..... | i |
| Motor Home Operations Manual (Binder)..... | i |
| Before Driving..... | i |
| Service Assistance..... | i |
| Reporting Safety Defects..... | ii |
| Drinking and Driving..... | ii |
| Vehicle Certification Label..... | iii |
| Exterior Feature Identification..... | iv |

SECTION 1: SAFETY PRECAUTIONS

| | |
|------------------------------|-----|
| General Warnings..... | 1-1 |
| Driving..... | 1-1 |
| Fuel & LP Gas..... | 1-1 |
| LP Gas Leaks..... | 1-2 |
| LP Gas Alarm..... | 1-2 |
| Electrical..... | 1-3 |
| Loading..... | 1-3 |
| Maintenance..... | 1-3 |
| Formaldehyde Warning..... | 1-3 |
| Carbon Monoxide Warning..... | 1-3 |
| Carbon Monoxide Alarm..... | 1-4 |
| Emergency Exit Window..... | 1-4 |
| Fire Extinguisher..... | 1-4 |
| Smoke Alarm..... | 1-5 |

SECTION 2: DRIVING YOUR MOTOR HOME

| | |
|-----------------------------------|-----|
| Before Entering..... | 2-1 |
| Before Driving..... | 2-1 |
| Keys..... | 2-1 |
| Fuel Selection..... | 2-2 |
| Gasoline Fuel Fill..... | 2-2 |
| Starting and Stopping Engine..... | 2-2 |
| Parking Brake..... | 2-2 |
| Hazard Warning Lights..... | 2-2 |
| Fuel Pump Shut-Off Switch..... | 2-2 |
| Door Locks and Handles..... | 2-2 |
| Entrance Step..... | 2-3 |
| Seats..... | 2-3 |
| Lounge Chairs..... | 2-4 |
| Seat Belts..... | 2-4 |
| Seat Belt Care & Cleaning..... | 2-5 |
| Child Restraints..... | 2-5 |
| Mirrors..... | 2-5 |
| Instrument Panel..... | 2-6 |
| Comfort Controls..... | 2-7 |
| Radio/Cassette Player..... | 2-7 |
| Aux. Start Switch..... | 2-7 |

SECTION 3: IN CASE OF DRIVING EMERGENCY

| | |
|-------------------------|-----|
| Hazard Flashers..... | 3-1 |
| Spare Tire..... | 3-1 |
| Tire Changing | |
| Safety Precautions..... | 3-1 |
| Wheel Nuts..... | 3-2 |

| | |
|-----------------------------------|-----|
| Recovery Towing..... | 3-2 |
| Jump Starting..... | 3-2 |
| Connecting a Battery Charger..... | 3-3 |
| Engine Overheat..... | 3-3 |

SECTION 4: TRAVELING WITH YOUR MOTOR HOME

| | |
|------------------------------------|----------|
| Loading the Vehicle..... | 4-1 |
| Roof Loading..... | 4-1 |
| Trailer Towing..... | 4-1 |
| Pre-Travel Checklist..... | 4-2 |
| Equipping For Travel | |
| Emergency Equipment Checklist..... | 4-2 |
| Quick Loading Checklist..... | 4-2, 4-3 |
| Travel Tips..... | 4-3 |
| Humidity & Condensation..... | 4-4 |
| Severe Weather Information..... | 4-4 |
| Nighttime Driving..... | 4-5 |
| Mountain Driving..... | 4-5 |
| Campsite Set-Up..... | 4-5 |
| Blocking..... | 4-5 |

SECTION 5: LP GAS SYSTEM

| | |
|--------------------------------|-----|
| LP Gas Supply..... | 5-1 |
| Safe Use of LP Gas System..... | 5-1 |
| How LP Gas Works..... | 5-1 |
| Selecting Fuel Types..... | 5-1 |
| LP Tank System..... | 5-2 |
| Refilling Tank..... | 5-2 |
| Air in the LP Gas Tank..... | 5-2 |
| Traveling with LP Gas..... | 5-2 |
| Regulator..... | 5-2 |
| LP Gas Leaks..... | 5-3 |
| Winter Use of LP Gas..... | 5-3 |

SECTION 6: ELECTRICAL SYSTEMS

| | |
|---|----------|
| 110-Volt AC System..... | 6-1 |
| External Power Cord (Shoreline)..... | 6-1 |
| Power Control Center (Converter)..... | 6-2 |
| Charging Section..... | 6-2 |
| Thermal Breaker..... | 6-2 |
| 110-Volt Circuit Breakers..... | 6-2 |
| 110-Volt Receptacles (Outlets)..... | 6-3 |
| Ground Fault Circuit Interrupter (GFCI).... | 6-3 |
| Auxiliary 110-Volt Generator | |
| Operating Instructions..... | 6-3, 6-4 |
| 12-Volt DC System..... | 6-5 |
| 12-Volt Fuses and Circuit Breakers..... | 6-5 |
| Auxiliary (Coach) Battery..... | 6-5 |
| Battery Maintenance..... | 6-6 |
| Battery Condition Meter..... | 6-6 |
| Trailer Wiring Connector..... | 6-6 |

SECTION 7: PLUMBING SYSTEMS

| | |
|-------------------------|-----|
| Fresh Water System..... | 7-1 |
| Filling Water Tank..... | 7-1 |

| | | | |
|---|------|--|------|
| Water Pump..... | 7-1 | Vehicle Maintenance | |
| Water Pump Switch..... | 7-1 | Chassis Service and Maintenance | 10-3 |
| Disinfection of Water Tank | 7-1 | Engine Access..... | 10-3 |
| External (City Water) Connector | 7-2 | Engine Cooling System..... | 10-3 |
| Shower Valve Pressure Bleed-Off..... | 7-2 | Tires..... | 10-3 |
| Exterior Shower..... | 7-3 | Suspension Alignment and | |
| Drainage System (Waste)..... | 7-3 | Tire Balance | 10-4 |
| Dumping Holding Tanks..... | 7-3 | Windshield Washers and Wipers..... | 10-4 |
| Using On-Site Sewer Hook-Ups | 7-4 | Lights..... | 10-4 |
| Holding Tank Level Indicators..... | 7-4 | Automotive 12-Volt Fuses | 10-4 |
| Holding Tank Capacities..... | 7-4 | Awning Installations | 10-4 |
| Water System Drain Valve Locations..... | 7-5 | SECTION 11: STORING AND WINTERIZING | |
| SECTION 8: APPLIANCES | | Preparing Vehicle For Storage | 11-1 |
| Refrigerator | 8-1 | Cold Weather Storage | |
| Range and Oven..... | 8-3 | (Winterizing) | 11-1 |
| Lighting Oven Pilot | 8-4 | Removal From Storage..... | 11-3 |
| Microwave Oven | 8-4 | | |
| Range Hood | 8-5 | | |
| Monitor Panel | 8-5 | | |
| Water Heater | 8-6 | | |
| Motor Aid Water Heater | 8-7 | | |
| LP Gas Furnace | 8-8 | | |
| Roof Air Conditioner..... | 8-8 | | |
| TV Antenna..... | 8-8 | | |
| TV Signal Amplifier..... | 8-9 | | |
| Cable TV Hook-Up..... | 8-9 | | |
| Exterior Entertainment Center..... | 8-10 | | |
| SECTION 9: INTERIOR FEATURES | | | |
| AND FURNISHINGS | | | |
| Sleeping Facilities | | | |
| Overhead Bunk..... | 9-1 | | |
| Couch/Bed Conversions..... | 9-1 | | |
| Dinette/Bed Conversion..... | 9-1 | | |
| Fresh Water Toilet..... | 9-1 | | |
| Power Roof Vent..... | 9-2 | | |
| Slider Windows | 9-2 | | |
| Quartz Wall Clock | 9-2 | | |
| Coffee Maker | 9-2 | | |
| SECTION 10: CARE AND MAINTENANCE | | | |
| Roof | 10-1 | | |
| Underbody..... | 10-1 | | |
| Exterior | 10-1 | | |
| Interior Maintenance..... | 10-1 | | |
| Carpet Care..... | 10-1 | | |
| Upholstery and Draperies | 10-2 | | |
| Cabinets..... | 10-2 | | |
| Vinyl Wallboard..... | 10-2 | | |
| Tables and Countertops..... | 10-2 | | |
| Stainless Steel Sink..... | 10-2 | | |
| Range and Refrigerator | 10-3 | | |
| Bathroom | 10-3 | | |
| Doors and Windows..... | 10-3 | | |
| Roll-Up Window Shade Adjustment.... | 10-3 | | |
| Pleated Window Shade Adjustment.... | 10-3 | | |

INTRODUCTION

Congratulations on the purchase of your new motor home, which has been carefully designed, engineered and quality built by Winnebago Industries, Inc.

OPERATOR'S MANUAL

Please read this operator's manual thoroughly. It was prepared in order to provide you with information necessary to properly and safely operate your new motor home.

This manual describes those instruments, controls and instructions which are unique to this motor home. For information regarding all other equipment, controls and instructions not described here, we urge you to read the "Chassis Operating Guide" and the equipment manufacturer's information provided in your "Motor Home Operation Manual".

This manual should be kept in the vehicle at all times for personal reference. The operator's manual, motor home operation manual and chassis operating guide are to be considered permanent components of this vehicle. They should remain in the vehicle when sold to provide the next owner with important safety, operating and maintenance information.

NOTE:

The descriptions, illustrations, and specifications in this manual were correct at the time of printing. We reserve the right to change specifications or design without notice, and without incurring obligation to install the same on products previously manufactured.

CHASSIS OPERATING GUIDE

Throughout this manual, frequent reference is made to the chassis operating guide. The chassis guide is the operator's manual provided by the manufacturer of the chassis on which this motor home is built (i.e., Chevrolet, Ford, etc.). Consult the chassis guide for operating safety and maintenance instructions pertaining to the chassis section of the motor home.

MOTOR HOME OPERATION MANUAL (Binder)

Your Motor Home Operation Manual contains information supplied by manufacturers of individual appliances and equipment installed in your motor home.

Consult this information regarding the operation and care of appliances, accessories and special equipment.

OPTIONS AND EQUIPMENT

This model is available in several sizes and floorplans, so accessories and components may differ slightly between models. Some equipment described in this manual may not apply to your coach.

BEFORE DRIVING

Before sitting in the driver's seat, always check around your vehicle to be sure you have proper clearance for maneuvering. If necessary, have a passenger help guide you into or out of a difficult parking space.

Although your coach features automotive conveniences like power steering and power brakes, driving a motor home is different from driving a car. A motor home is larger and heavier than an automobile, so it requires more stopping and passing distance, and more parking and maneuvering space than does a car.

Always be aware of the size of your motor home. The added height of roof air conditioners, TV antennas or luggage boxes may cause clearance problems around some tunnels, canopies and hanging signs. Know the height of your unit so you can observe posted clearance limits. Also, remember that some bridges, old ones in particular, may not support the weight of your motor home. Know the weight of your unit and observe any posted weight limits.

Remember: Always use your seat belt and instruct your passenger's to do so as well. We also advise making frequent rest stops while traveling to relieve stress on yourself, your passengers and your vehicle.

Special Note to Model 429WQ (Wide Body) Owners:

Your coach features an exciting new wide body design that exceeds the normal 96" body width. Always be aware of the additional width of your coach while driving or maneuvering to avoid clearance problems. Also, please be aware that some states restrict access to some or all state roads to a maximum 96" body width. When making travel plans, check the road usage laws of the states through which you plan to travel to be sure your chosen route does not include this restriction.

SERVICE AND ASSISTANCE

Your dealer will be glad to provide any additional information you need, as well as answer any questions you might have about operating the equipment in your motor home. When it comes to service, remember that your dealer knows your vehicle best and is interested in your satisfaction. Your dealer will provide quality maintenance and any other assistance that you may require during your ownership of this vehicle.

If you need warranty repairs while traveling, however, you may take your motor home to any Winnebago or Itasca dealership and they will assist you.

WARRANTY

Your new vehicle is covered by a factory warranty against defects in material and workmanship. This warranty should be validated immediately and returned to the factory by your dealer. For additional information, see your "New Vehicle Limited Warranty" included with this vehicle.

DRINKING AND DRIVING

Winnebago Industries supports the recommendations of the Presidential Commission on Drunk Driving.

- Exercise your good judgement and encourage others to do the same.
- Know the legal limits and do not exceed them.
- Also know your personal limits, which may be lower than the legal limits.
- Should you ever exceed your limits, find alternative transportation; call a cab, ask a friend to drive you home or call a family member to come and get you.

The presence of alcohol in significant levels in the blood increases the probability that the driver will be involved in an accident.

REPORTING SAFETY DEFECTS

If you believe that your vehicle has a defect which could cause a crash or could cause injury or death, you should immediately inform the National Highway Traffic Safety Administration (NHTSA) in addition to notifying Winnebago Industries, Inc.

If NHTSA receives similar complaints, it may open an investigation, and if it finds that a safety defect exists in a group of vehicles, it may order a recall and remedy campaign. However, NHTSA cannot become involved in individual problems between you, your dealer, or Winnebago Industries.

To contact NHTSA, you may either call the Auto Safety Hotline toll-free at 1-800-424-9393 (or 366-0123 in Washington, D.C. area) or write to: NHTSA, U.S. Department of Transportation, Washington, D.C. 20590. You can also obtain other information about motor vehicle safety from the Hotline.

VEHICLE CERTIFICATION LABEL

This label contains vehicle identification and other important reference information. The label is attached to the lower area of the driver's door latch post. Never remove or destroy this label.

| | | | |
|--|---|---|----------------------------------|
| MANUFACTURED BY WINNEBAGO [®] Winnebago Industries, Inc. | | INCOMPLETE VEHICLE MANUFACTURED BY 1 MOTORS CORP. | |
| 3 | MONTH AND YEAR OF MANUFACTURE: 2 | | |
| | GVWR 4 LB. _____ KG | | |
| GAWR: | | SUITABLE TIRE AND RIM CHOICE | COLD INFLATION PRESSURE |
| FRT. | LB _____ KG _____ | TIRE _____ RIM _____ | PSI _____ K Pa _____ |
| INT. | 5 LB _____ KG 6 | 7 | 8 PSI _____ K Pa 9 |
| RR. | LB _____ KG _____ | | PSI _____ K Pa _____ |
| THIS VEHICLE CONFORMS TO ALL APPLICABLE FEDERAL MOTOR VEHICLE SAFETY STANDARDS IN EFFECT ON THE DATE OF MANUFACTURE SHOWN ABOVE. | | | |
| SERIAL NO. 10 _____ VIN 11 _____ | | | |
| TYPE 12 _____ MODEL 13 _____ COLOR 14 _____ | | | |

Explanation of Data

1. Chassis manufacturer.
2. Chassis manufacture date.
3. Month and year of manufacture at Winnebago Industries.
4. Gross Vehicle Weight Rating: Total permissible weight of the vehicle, including driver, passengers, total cargo carried (including all liquids) and equipped with all options.
5. Gross Axle Weight Rating: Total permissible weight allowed for the front, intermediate* and rear axles (listed in pounds and kilograms).
6. Suitable Tire Choice: Tires recommended to meet handling and safety requirements. When replacing any of the tires on your vehicle, always replace with a tire that meets these specifications.
7. Suitable Rim Choice: Wheel rims recommended to meet handling and safety requirements. When replacing any of the rims on your vehicle, always replace with a rim that meets these specifications.
8. Cold Inflation Pressure: Inflation pressures recommended (while cold) for the tires originally equipped on your vehicle. These pressure levels must be maintained to assure proper handling, safety and fuel economy.
9. Intermediate* and Rear Axle Wheel Configuration: Single or Dual.
10. Serial Number: This is the serial number assigned to the completed vehicle by Winnebago Industries.
11. Vehicle Identification Number (VIN): This number identifies the chassis on which the motor home is built.
12. Type: States the NHTSA designated usage classification for your motor home. MPV signifies a Multipurpose Passenger Vehicle.
13. Model: Lists the Winnebago Industries product model number of your vehicle.
14. Color: Signifies the color code number of the decor used throughout the vehicle. This number is necessary for ordering replacement cushions, curtains, carpet, etc.

*Intermediate (INT) data applies only to Class-A models equipped with tag axle.

EXTERIOR FEATURE IDENTIFICATION - Class C Motor Homes

Typical model shown for illustration purposes.

Actual locations of features depends on your model and option combinations

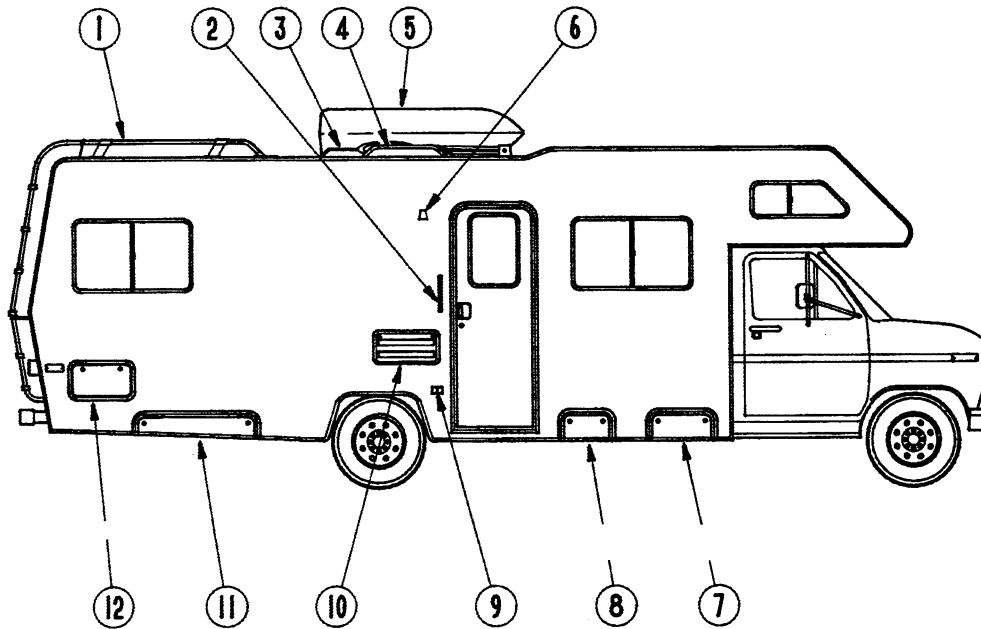

- | | |
|-------------------------|----------------------------------|
| 1. Roof Rack & Ladder | 7. LP Gas Tank Access |
| 2. Assist Handle | 8. Storage Compartment* |
| 3. TV Antenna | 9. 110-Volt Outlet |
| 4. Refrigerator Vent | 10. Refrigerator Access |
| 5. Roof Air Conditioner | 11. Storage Compartment |
| 6. Porch Light | 12. Underbed Storage Compartment |

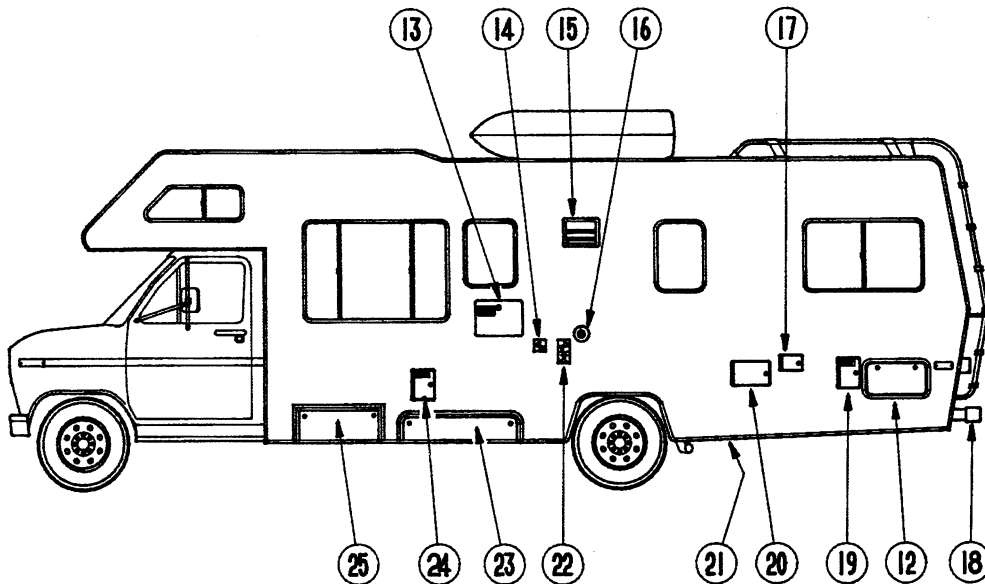

- | | |
|----------------------------------|-------------------------------------|
| 12. Underbed Storage Compartment | 19. Fuel Fill Door |
| 13. Water Heater Access | 20. Auxiliary Shower |
| 14. Furnace Intake/Exhaust | 21. Sewage Drain Location |
| 15. Range Hood Vent | 22. Furnace Intake/Exhaust |
| 16. City Water Connection | 23. Storage Compartment |
| 17. Water Tank Fill Door | 24. Shoreline Compartment** |
| 18. Sewage Drain Hose Storage | 25. Auxiliary Generator Compartment |

* Coach battery compartment on some models
 ** Also cable TV hook-up on some models

SECTION 1

SAFETY PRECAUTIONS

Read and understand all instructions and precautions in this manual before operating your new motor home. The symbol WARNING is used throughout the manual to alert you to precautions that involve your personal safety. Read and follow them carefully. Listed are some safety precautions that must be adhered to. These precautions as well as others that involve damage to equipment are also listed in the appropriate areas in this manual.

GENERAL WARNINGS

- Only seats equipped with seat belts are to be occupied while the vehicle is moving.
- Make sure all passengers have seat belts fastened in a low and snug position so the force exerted by the belt in a collision will be spread across the strong hip area.
- Never allow passengers to stand or kneel on seats while the vehicle is in motion.
- Sleeping facilities are not to be used while vehicle is moving.
- Examine the escape window and be familiar with its operation, but do not use except in an emergency.
- Inspect the fire extinguisher monthly for proper charge and operating condition. This should also be done before beginning a vacation or any extended trip.

DRIVING

- Do not attempt to adjust the driver's seat while the vehicle is in motion.
- Do not adjust tilt steering in a moving vehicle.
- Do not operate the cruise control on icy or extremely wet roads, winding roads, in heavy traffic, or in any other traffic situation where a constant speed cannot be maintained.
- Use care when accelerating or decelerating on a slippery surface. Abrupt speed changes can cause skidding and loss of control.

- Driving through water deep enough to wet the brakes may affect stopping distance or cause the vehicle to pull to one side. Check brake operation in a safe area to be sure they have not been affected. Never operate any vehicle if a difference in braking efficiency is noticeable.
- Adverse weather conditions and extremes in terrain may affect handling and/or performance of your vehicle. Refer to your chassis manual for related information.

FUEL & LP GAS

- All pilot lights must be extinguished and appliances turned off while refilling the fuel tank or LP tank.
- Never smoke while refilling vehicle fuel tank or LP gas tank.
- Avoid inhaling exhaust gases produced by burned gasoline, diesel fuel or LP gas in items such as the range, chassis engine, generator engine, refrigerator, furnace and water heater. They contain carbon monoxide, which is an odorless, colorless and poisonous gas.
- Do not bring or store LP gas containers, gasoline or other flammable liquids inside the vehicle because a fire or explosion may result. LP gas containers are equipped with safety valves which relieve excessive pressure by discharging gas to the atmosphere.
- Do not alter the LP gas system at any time or in any way.
- Do not fill LP gas container(s) above 80 percent of capacity. Overfilling the LP gas container can result in uncontrolled gas flow which can cause fire or explosion. A properly filled container will contain approximately 80 percent of its volume as liquid LP gas.
- Never use an open flame to test for LP gas leaks. Replace all protective covers and caps on LP system after filling. Make sure valve is closed and door latched securely.

- Never connect natural gas to the LP gas system.
- When lighting range burners do not turn burner controls to "On" and allow gas to escape before lighting match.
- Portable fuel-burning equipment, including wood and charcoal grills and stoves, shall not be used inside the recreational vehicle. The use of this equipment inside the recreational vehicle may cause fires or asphyxiation.
- LP gas regulators must always be installed with the diaphragm vent facing downward. Regulators that are not in compartments have been equipped with a protective cover. Make sure that the regulator vent faces downward and that the cover is kept in place to minimize vent blockage which could result in excessive gas pressure causing fire or explosion.
- The following warning label is located in the cooking area to remind you to provide an adequate supply of fresh air for combustion.

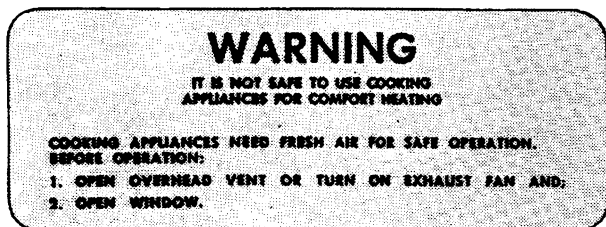

Unlike large homes, the oxygen supply inside a recreational vehicle is limited due to its size. To avoid danger of asphyxiation, provide proper ventilation when using the gas rangetop or gas oven. It is especially important that the gas oven and rangetop not be used for comfort heating. Danger of asphyxiation is greater when these appliances are used for long periods of time.

LP GAS LEAKS

The following label is located in the vehicle near the range area. If you smell gas within the vehicle, quickly and carefully perform the procedures listed.

| |
|---|
| <p>IF YOU SMELL GAS</p> <ol style="list-style-type: none">1. Extinguish any open flames, pilot lights and all smoking materials.2. Do not touch electrical switches.3. Shut off the gas supply at the tank valve(s) or gas supply connection.4. Open doors and other ventilating openings.5. Leave the area until odor clears.6. Have the gas system checked and leakage source corrected before using again. |
|---|

LP Gas Alarm

Your coach is equipped with an LP gas detector which sounds an alarm if an unsafe amount of LP gas is present inside the coach. Because LP gas is heavier than air, the detector is located on a cabinet face near the floor of the coach.

A green light on the face of the alarm shows when the unit is active. The red button is used to reset the alarm.

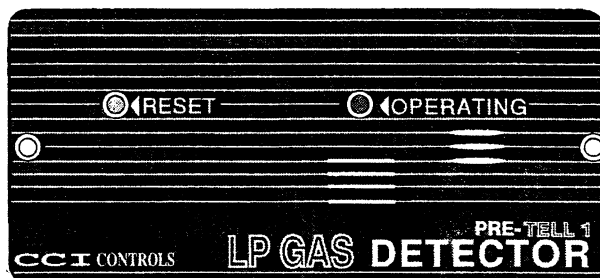

If the Alarm Sounds

If the alarm sounds, do not touch any electrical switches. Immediately turn off the main LP tank valve and all LP appliances, open all windows and roof vents, and leave the coach until the alarm stops sounding.

If the alarm keeps sounding at regular intervals, a leak may be present. Turn off the main LP tank valve and contact your dealer or an LP gas service center to have the problem corrected before using the LP system again.

| |
|---|
| <p>WARNING</p> <p>Never use an open flame to test for gas leaks.</p> |
|---|

Power Connection

The gas alarm is powered by the coach batteries. If the battery cable is disconnected from the batteries or the fuse is blown, the alarm will not work. The LP gas alarm fuse is located on the power converter fuse panel shown on page 6-5.

Further Information

See the manufacturer's information entitled "Your LP Gas Detector" in the operations manual binder for further instructions on nuisance alarms and care and testing of the LP gas detector.

ELECTRICAL

- Careless handling of electrical components can be fatal. Never touch or use electrical components or appliances while feet are bare, while hands are wet, or while standing in water or on wet ground.
- Improper grounding of the vehicle can cause personal injury. Do not plug the utility power cord into an outlet which is not grounded and do not adapt the plug to connect to a receptacle for which it is not designed.
- Do not attach an extension cord to the utility power cord.
- Be sure that all electrical appliances to be used contain 3-prong plugs for proper grounding.
- Avoid overloading electrical circuits. Replace fuses or circuit breakers with those of the same size and amperage rating only. Never use a higher rated fuse or breaker.
- Use caution when handling or working near electrical storage batteries. Always remove jewelry and wear protective clothing and eye covering. Avoid creating sparks.

LOADING

- Store or secure all loose items inside the motor home before traveling.
- Be aware of GVWR, GAWR and individual load limit on each tire or set of duals. (See "Loading the Motor Home" in Section 4.)
- Never load the motor home in excess of the gross vehicle weight rating or the gross axle weight rating for either axle.

MAINTENANCE

- Do not remove the radiator cap while engine and radiator are still hot. Always check coolant level visually at the see-through coolant reservoir.

- Never get beneath a vehicle that is held up by a jack only.
- Do not mix different construction types of tires on the vehicle such as radial, bias or belted tires, as vehicle handling may be affected. Replace tires with exact size, type and load range.
- Do not attempt to start the vehicle by hot wiring.

FORMALDEHYDE INFORMATION

WARNING

Some components in this vehicle contain formaldehyde based adhesives which may release formaldehyde fumes into the air for an unknown period of time until total dissipation occurs. Individuals who are allergic to formaldehyde gas fumes may experience irritation to eyes, ears, nose and throat. Reaction in infants may be more severe. Although long range effects are not well understood, testing to date has not revealed any serious health effects in humans at the level of emission from these products.

IMPORTANT

To aid in dissipation, ventilate the vehicle by opening all windows and circulating the air with a fan.

CARBON MONOXIDE WARNING

WARNING

Avoid inhaling exhaust gases, as they contain carbon monoxide, which is a colorless, odorless and poisonous gas.

If you suspect that exhaust fumes are entering the passenger compartment, have the cause determined and corrected as soon as possible. If you must drive under these conditions, drive only with ALL WINDOWS FULLY OPENED.

The best protection against carbon monoxide entry into the vehicle body is a properly maintained engine exhaust and ventilation system. It is recommended that the exhaust system and body be inspected by a qualified motor home service center.

- Each time the vehicle is raised for an oil change.
- Whenever a change in the sound of the exhaust system is noticed.
- Whenever the exhaust system, underbody or rear of the vehicle is damaged.

To allow proper operation of the vehicle's ventilation system, keep front ventilation inlet grill clear of snow, leaves or other obstructions at all times. **DO NOT OCCUPY A PARKED VEHICLE WITH ENGINE RUNNING FOR AN EXTENDED PERIOD.**

Do not run engine in confined areas, such as a garage, except to move vehicle in or out of area. When vehicle is stopped in an UNCONFINED area with the engine running for any more than a short period, adjust heating or cooling system to force outside air into the vehicle as follows:

1. Set fan to medium or high speed and vent control to "air".
2. On vehicles equipped with air conditioning, set fan to medium or high speed and set control to obtain maximum vent air.

Rear windows should be closed while driving to avoid drawing dangerous exhaust gases into the vehicle.

CARBON MONOXIDE ALARM

If your coach is equipped with a carbon monoxide (CO) alarm, it will be located on the ceiling in the bedroom area. The CO alarm is powered by a battery/sensor pack and is designed to detect toxic carbon monoxide gas fumes resulting from incomplete combustion of fuel. It will detect CO gas from any combustion source such as the furnace, gas range/oven, water heater, refrigerator, chassis engine, or electric generator engine.

For further information, please read the manufacturer's guide included in your Motor Home Operations Manual binder. It includes information on precautions, operational testing, and battery/sensor replacement.

EMERGENCY EXITS

EMERGENCY EXIT WINDOW

Your motor home is equipped with an emergency exit window in the rear of the vehicle which functions as an escape exit in an emergency situation.

The glass is installed with a rubber extrusion. It is opened by pulling on the red plastic loop, located at the bottom of the window, until the rubber cord is completely removed. This allows the window to be pushed out. Instructions for removal are also located on a label on the glass for quick reference and for passengers who may not be familiar with the exit. Be sure this label is never removed or destroyed.

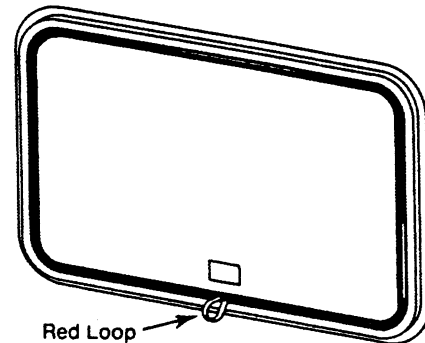

WARNING

Use emergency window for emergency exit only. Do not test for proper operation.

If the cord is released by accident, but the glass remains in place, the cord can be replaced using a blunt instrument, preferably one made of plastic. We suggest you contact your dealer for assistance.

WARNING

Use care when exiting emergency window, as broken glass may be present in the exit area.

USING SLIDER WINDOWS AS EMERGENCY EXITS

Most single and double slider windows along the side of the motor home can also be used as emergency exits, should the need arise. To use the windows as exits, slide the window open, then strike the screen near one corner to loosen it and push out.

FIRE EXTINGUISHER

A dry chemical fire extinguisher is located near the floor by the side entrance door.

We recommend that you become thoroughly familiar with the operating instructions displayed on the side of the fire extinguisher or in the information supplied in your Motor Home Operations Manual binder.

We also recommend that you inspect the fire extinguisher for proper charge at least once a month in accordance with National Fire Protection Association (NFPA) recommendations as stated on the label. If the charge is insufficient, the fire extinguisher must be replaced.

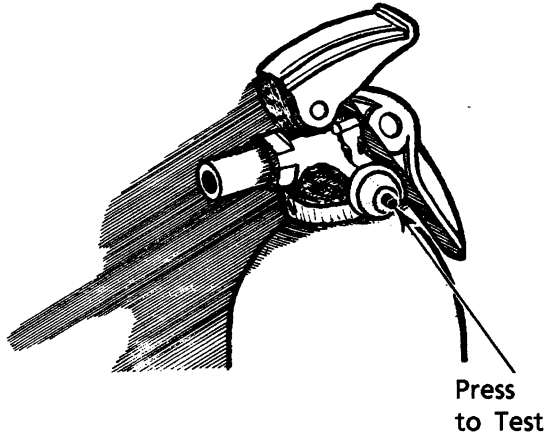

2. Your smoke alarm will not work without power. Never remove the battery to quiet the alarm. When your smoke alarm "beeps" about once a minute the battery is weak. Immediately install a new battery. Be sure to use only batteries specified in manual or on unit. Test unit after installing a new battery.
3. Clean and vacuum the openings on your smoke alarm once a month.
4. Do not open the smoke alarm or try to repair it. For replacement information see warranty in Owner's Manual.
5. Smoke alarms have technical limitations and may not respond in all situations. FIRE PREVENTION is your best safeguard.

See your motor home Operation Manual binder for further information.

SMOKE ALARM

Your motor home is equipped with a smoke alarm located on the ceiling in the galley area. This alarm meets U.L. Standard 217 and NFPA Standard 74 for operation of smoke detection devices.

1. The smoke alarm should be tested for correct operation each time the vehicle is brought out of storage, before each trip, and at least once a week during motor home use.

To test the electronics, firmly depress the button. To test that smoke reaches the sensor, blow smoke in a careful, fire-safe manner into your smoke alarm.

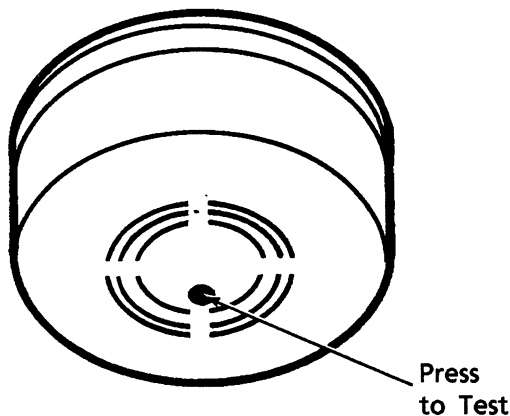

SECTION 2

DRIVING YOUR MOTOR HOME

(See also Safety Precautions, Section 1 of this manual.)

IMPORTANT

See your Chevy or Ford chassis operator's guide for information on starting the engine, operating the transmission, steering column controls, descriptions of instrument gauges and other chassis related information.

Some items described in this section may be optional or unavailable on your coach.

BEFORE ENTERING YOUR VEHICLE

Before entering your vehicle, there are a few recommended procedures that will aid in your driving safety and equipment.

1. Be sure that the windows, mirrors and light lenses are clean and unobstructed.
2. Make sure all exterior lights operate properly.
3. Check tires for proper cold inflation pressures.
4. Check wheel lug nuts for tightness.
5. Look beneath the vehicle for noticeable fluid leakage.
6. Check fluid levels and fill if necessary. This includes engine oil, transmission fluid, coolant, brake fluid, power steering fluid and windshield washer solvent.

WARNING

The transmission must be in P (Park) and park brake engaged while performing any checks or adjustments.

The engine should be shut off unless specifically required for a certain procedure.

7. Unhook and store sewer and water supply hoses.
8. Retract step.
9. Be sure that all of your cargo is secured in event of a sudden stop or an accident.
10. Check around your vehicle in all directions to assure that you have proper clearance.
11. Lower TV antenna.
12. Disconnect and store shoreline.

WARNING

Before driving your vehicle, be sure you have read the entire operator's manual and that you understand your vehicle's equipment completely and how to use the equipment safely.

BEFORE DRIVING YOUR VEHICLE

Before preparing to drive your vehicle, here are a few recommended procedures that will add to your driving safety and enjoyment.

1. Be sure that you adjust the interior and exterior rear view mirrors to your driving preference.
2. Adjust the driver's seat for proper distance from foot pedals and steering wheel to allow for safety and ease in controlling your vehicle.
3. Place front seats in the forward facing position.
4. Be sure to fasten all safety belts to fit you comfortably, but tight enough to obtain the full safety of the belts.
5. Make sure all doors are completely shut and locked. When the doors are locked and shut, there is less chance of the doors flying open in event of an accident. It also prevents unintentional opening of doors and keeps intruders out of your vehicle.
6. Check to see that all gauges are operating properly.
7. Check the fuel level in the vehicle.
8. Be certain that the fire extinguisher is fully charged and secure in its mounting bracket.

CAUTION

Be sure hood and all compartment doors are latched securely before driving vehicle.

KEYS

Your motor home is supplied with several sets of keys. In addition to the chassis manufacturer's ignition key, you receive keys for front doors, entrance door, and exterior compartment doors.

Each set of keys has an identification number, either on a small metal tag or stamped into the key head. Record these numbers and keep them in a safe place. In case keys are lost or stolen, your

dealer or a locksmith can provide you with duplicate keys or modify the locks.

FUEL SELECTION

Refer to your chassis operating guide for the manufacturer's recommendations on proper fuel selection.

WARNING

Modern fuel systems may build up pressure within the tank as the gasoline warms during use or in hot weather.

Under certain conditions, sudden release of this pressure when removing the gasoline cap can spray gasoline from the fuel fill opening, causing a possible hazard.

GASOLINE FUEL FILL

REMOVING THE FUEL CAP

When removing the gasoline cap, slowly rotate it only far enough to allow pressure to release. After any "hissing" sounds stop, continue removing the cap.

FILLING THE TANK

Do not overfill the fuel tank. Allow gasoline to pump into the tank until the auto-shutoff valve in the fuel pump nozzle stops the flow of fuel, indicating a full tank. This provides a pre-determined vapor space at the top of the tank to allow for expansion of the gasoline.

CAUTION

Continuing to fill above this level may cause damage to the fuel/evaporative emissions system.

Fuel Capacities:

| | |
|---------------------|----------|
| Chevy Chassis | 33 Gals. |
| Ford Chassis | 55 Gals. |
| Ford Diesel Models: | 38 Gals. |

REPLACEMENT FUEL CAPS

To protect gasoline system from excessive pressure or vacuum, or from sudden pressure, replace lost caps with caps of the same design available from your dealer.

STARTING AND STOPPING ENGINE

Refer to your chassis operating guide for the manufacturer's recommendations on starting and stopping the engine.

PARKING BRAKE

Never drive your vehicle with the parking brake set. This will reduce parking brake effectiveness and cause excessive wear. Consult your chassis operating guide in your Motor Home Operations Manual for operating instructions.

HAZARD WARNING LIGHTS

See chassis operating guide for location of hazard flasher switch. See Section 3 for further operating information.

FUEL PUMP SHUT-OFF SWITCH (Ford Chassis Only)

Vehicles built on Ford chassis are equipped with an inertial type switch that shuts off the fuel pump in the event of collision. This switch must be manually reset to resume the fuel supply to the engine.

See your chassis operating guide for location and reset procedures for this switch.

IMPORTANT

It is possible to inadvertently trigger this switch by abruptly striking an object such as a curb or parking block. If your vehicle exhibits symptoms of running out of fuel immediately after such an occurrence, the fuel pump shut-off switch may need to be reset.

See your chassis operating guide for additional information.

DOOR LOCKS AND HANDLES

IMPORTANT

Keys should always be removed when leaving the vehicle. Since doors can be locked without keys, make sure they have been removed from the ignition before locking the driver's compartment.

The entrance door may be opened from outside the vehicle by pulling the door handle outward. To open the door from inside, pull outward on the door handle. When the door is locked, neither the inside nor the outside door handle can be operated.

ENTRANCE DOOR LOCK AND HANDLE

The entrance door may be opened from outside the vehicle by pulling the door handle outward. To open the door from inside, pull outward on the door handle. When the door is locked, neither the inside nor the outside door handle can be operated. It can be locked and unlocked from the outside of the vehicle by inserting the key into the lock and turning.

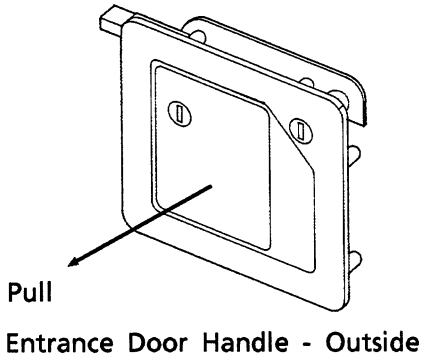

To lock the door from inside, rotate the lock levers as indicated. The deadbolt lock is for added security and should be used as a security night lock.

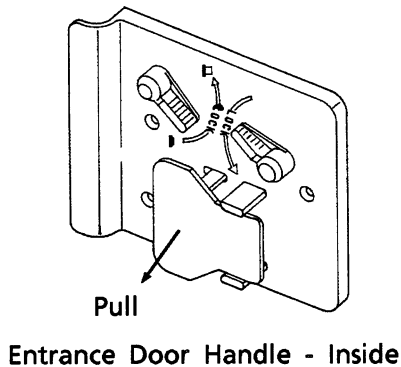

Lubricate the locks periodically with graphite to maintain good working condition.

CAUTION

When releasing security night lock, be sure to retract bolt before opening door latch to prevent drag on bolt pin. Instruct all passengers in operation of this door catch system as well as emergency exit window.

DRIVER COMPARTMENT DOOR LOCK

Consult your chassis operating guide.

ENTRANCE STEP

To extend the entrance step, lift up on the front of the step and pull out until it drops into position. To retract, lift up on front of step and push back until step locks into travel position.

WARNING

Do not use step unless it is fully extended.

CAUTION

Always remember to retract the entrance steps before traveling or moving the vehicle.

SEATS

The driver and co-pilot seats may be independently adjusted to suit individual preference. To move the set forward or backward, lift the slide release paddle, located on the lower left side of the seat, and exert slight body pressure in the direction desired.

The seats may be swiveled to provide easy entrance and exit. The swivel feature also allows the seats on some models to be turned toward the living area for additional seating while the unit is parked. To swivel the seats, lift the release paddle, located on the lower right side of the seat, and rotate seat. The seats are designed to lock only when returned to the forward facing position.

To recline the seats, lift the reclining paddle, lean back to desired incline and release the paddle. To return to the upright position, lift the paddle and lean body forward. Allow the seat to return to the desired position and release the paddle.

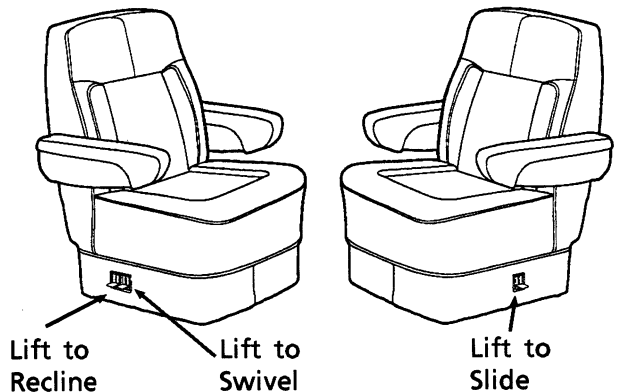

WARNING

Do not adjust driver's seat while vehicle is in motion.

After adjusting seat, always use body pressure to make sure slide and swivel locking mechanisms have engaged.

Arm Rest Adjustment

The driver and co-pilot seat armrests may be adjusted to rest at two different positions as shown.

Position 1 - Raise armrest, push in toward seat, and lower into position. This position would generally be used when the seat is in the upright position.

Position 2 - Raise armrest, pull outward from seat, and lower into position. You may wish to use this position when you recline the seat.

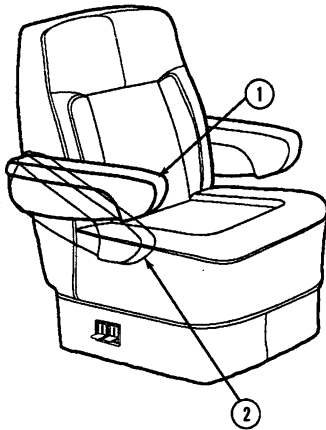

LOUNGE CHAIR

The lounge chair has swivel and slider features to allow you to position the seat to your liking.

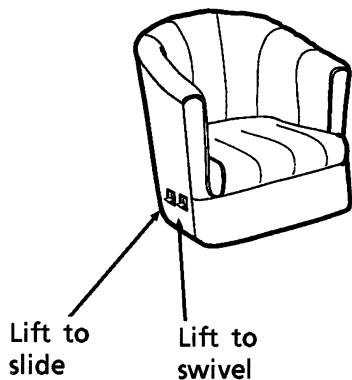

To swivel the seat: Pull up on the swivel lever located on the lower right side of the seat. The seat will lock into place whenever it reaches the center aisle facing position.

Always return the seat to the aisle facing position for proper use of seat belts while traveling.

To slide the seat: Pull up on the slide lever located on the lower right side of the seat. Slide to desired position and release lever.

SEAT BELTS

Seats intended for occupancy while the vehicle is in motion are equipped with seat belts for the protection of the driver and passengers. The lap belts must be worn as low as possible and fit snugly across the hip area. Always sit erect and well back into the seat. To gain full protection of the safety belt, never let more than one person use the same safety belt at any one time, and do not let the safety belts become damaged by pinching them in the doors or in the seat mechanism. After any serious accident, any safety belts which were in use at the time should be replaced.

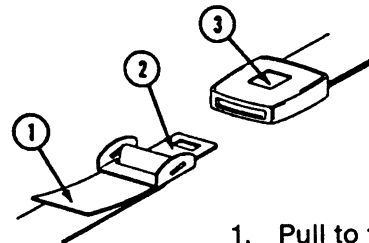

1. Pull to tighten.
2. Tongue.
3. Push to release.

Adjustment: To lengthen belt, turn tongue at a right angle to belt and pull to desired length. To shorten, pull loose end of belt.

To Fasten: Be sure belt is not twisted. Grasp each part of the belt assembly and push tongue into buckle. Adjust to a snug fit by pulling the loose end away from the tongue.

To Release: Depress button in center of buckle and slide tongue out of buckle.

WARNING

Snug and low belt positions are essential. This will ensure that the force exerted by the lap belt in a collision is spread over the strong hip area and not across the abdomen, which could result in serious injury.

Only seats equipped with seat belts are to be occupied while vehicle is in motion.

LAP-SHOULDER BELT

Fastening: Hold the belt just behind the tongue using the hand nearest to the door. Next, bring the belt across the body and slide the tongue into the buckle until the latch engages.

Unfastening: Press the release button in the buckle. Hold onto the tongue when you release it from the buckle to keep it from retracting too rapidly.

When the lap-shoulder belt is in use, the lap portion must ride across the strong hip area and the shoulder portion must ride diagonally over the shoulder blade toward the buckle.

The shoulder belt is designed to lock only during a sudden stop, sudden body movement or a collision. At all other times it will move freely with the occupant.

WARNING

Never wear the shoulder belt in any position other than as stated above. Failure to do so could increase the chance or extent of injury in a collision.

CARE AND CLEANING

- Be careful not to damage the belt webbing and hardware. Take care not to pinch them in the seat or doors.
- Inspect the belts and hardware periodically. Check for cuts, frays, and loose parts. Damaged parts should be replaced. Do not remove or modify the belt system.
- Keep belts clean and dry. If the belts need cleaning, use only a mild soap and water solution. Do not use hot water. Do not use abrasive cleaners or bleach. These products may weaken or damage the belts.
- Replace any belt assembly that was used during a severe impact. Replace the complete assembly even if damage is not apparent.

CHILD RESTRAINTS

All 50 of the United States and the District of Columbia now require the use of the child/infant restraint systems for children in vehicles.

A properly installed and secured child restraint system can help reduce the chance or severity of personal injury to a child in an accident or during a sudden maneuver. Children may be injured in an accident if they are not seated in a child restraint which is not properly secured.

A child restraint system is designed to be secured in a vehicle seat by a lap belt or the lap belt portion of a lap-shoulder belt. According to accident statistics, children are also safer when properly restrained in rear seating positions than in front seating positions.

When purchasing a child restraint system:

1. Look for the label certifying that it meets all applicable U.S. Federal Motor Vehicle Safety Standards (FMVSS) or, in Canada, requirements of the Children's Car Seats and Harnesses Regulations (CCSHR).
2. Make sure that it will attach to your vehicle and restrain your child securely and conveniently so that you are able to install it correctly each time it is used.
3. Be certain that it is appropriate for the child's height, weight and development. The instructions and/or the regulation label attached to the restraint typically provides this information.
4. Review the instructions for installation and use of the restraint. Be sure that you understand them fully and can install the restraint properly and safely in your vehicle.

MIRRORS

Always adjust mirrors for maximum rear visibility before driving off. Make sure the seat is adjusted for proper vehicle control and that you are sitting back squarely into the seat.

Tilt the surface of the mirror gently up or down, left or right, to obtain the best rear view.

The following illustrations show available features. Your motor home may not be equipped with every option. See your chassis operating guide for specific descriptions and operating instructions for these controls.

**INSTRUMENT PANEL
(Ford Chassis)**

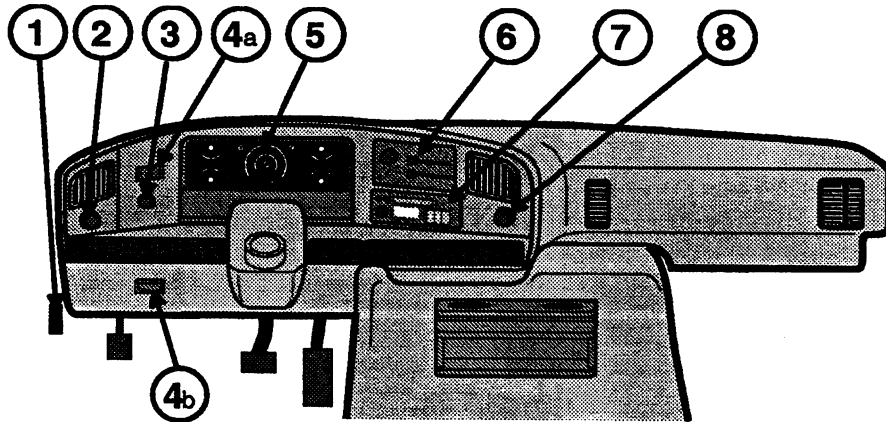

- | | |
|--|----------------------------------|
| 1. Hood Release Knob | 5. Instrument Cluster |
| 2. Headlight Switch | 6. Automotive Heater/AC Controls |
| 3. Rear Auto Heater Switch | 7. Radio/Cassette Player** |
| 4a. Aux. Start Switch (Gas Chassis) | 8. Cigarette Lighter/12V Jack |
| 4b. Aux. Start Switch (Diesel Chassis) | |

**INSTRUMENT PANEL
(Chevrolet Chassis)**

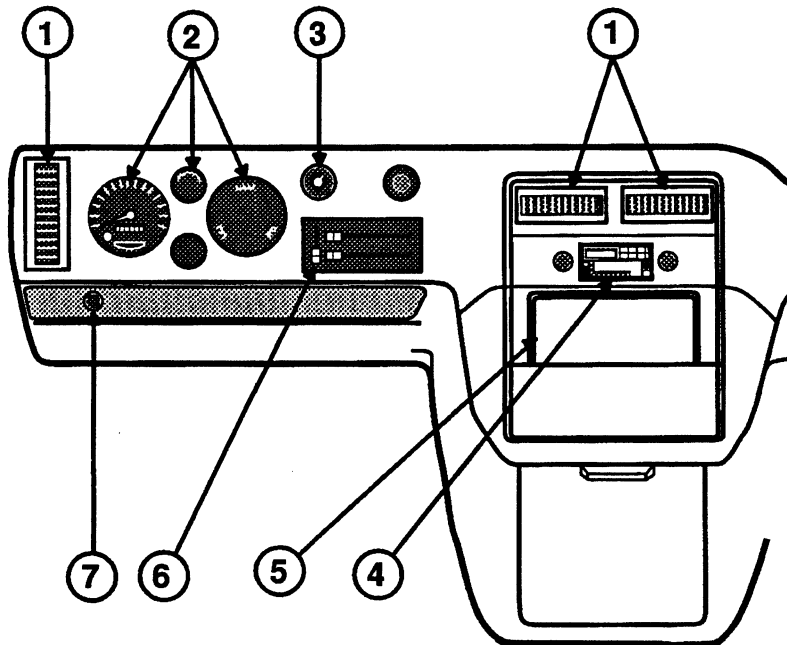

- | | |
|----------------------------------|------------------------------------|
| 1. Vent/Air Conditioner Register | 5. Ashtray/Cigarette Lighter |
| 2. Instrument Cluster | 6. Heater/Air Conditioner Controls |
| 3. Rear Auto Heater | 7. Headlight Switch |
| 4. Radio/Cassette Player** | |

** See manufacturer's operating information.

STEERING COLUMN CONTROLS

See your chassis operating guide for all controls located on the steering column or steering wheel.

WARNING

Do not operate the cruise control on icy or extremely wet roads, winding roads, in heavy traffic, or in any other traffic situation where a constant speed cannot be maintained.

COMFORT CONTROLS

AUTO AIR CONDITIONER/HEATER

See your chassis operating guide for operating instructions for dash mounted automotive heater-air conditioner controls.

IMPORTANT

The automotive air conditioner is not designed to cool the entire interior of the motor home, but is intended to cool the driver's compartment only.

REAR AUTOMOTIVE HEATER

To provide heat to the rear of the vehicle while driving, turn the rear heater fan switch to the desired speed.

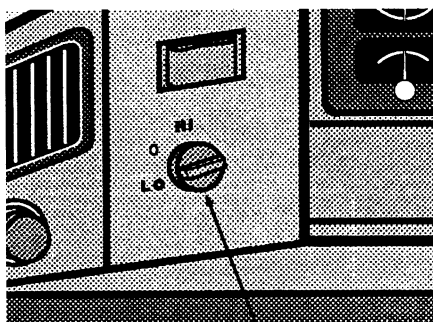

Rear Heater
Switch

RADIO/CASSETTE PLAYER

Most models are available with a standard or optional AM/FM radio/cassette player that provides high quality stereo sound for your traveling and living enjoyment. Refer to your Motor Home Operation Manual for operating and care instructions.

CAUTION

If your radio is equipped with an electronic tuning receiver, disconnect the radio power leads before attaching a battery charger or jumper cables to the battery. The radio tuner may become damaged if this is not done.

AUX. START SWITCH

This switch can be used to provide emergency starting power from the motor home auxiliary battery if the automotive battery is dead.

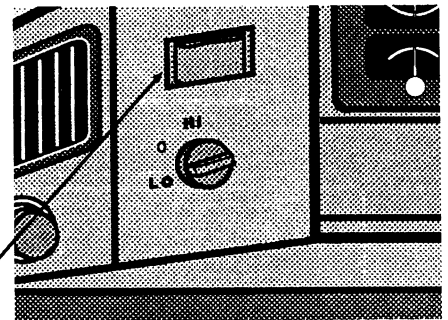

If engine battery is dead, press while turning key for emergency starting power.

Aux. Start Switch

On Chevy-powered coaches this switch is located on the wall behind the driver's door.

On Ford-powered coaches it is located on the instrument panel as shown on page 2-6. If you have a diesel-powered model the switch is on the lower dash panel.

SECTION 3

IN CASE OF DRIVING EMERGENCY

HAZARD WARNING FLASHER

The hazard warning flasher provides additional safety when the vehicle must be stopped on the side of the roadway and presents a possible hazard to other motorists. When the flasher is on, it serves as a warning to the other drivers to approach and overtake your vehicle with caution.

WARNING

Operating the hazard warning flasher system while moving on the highway is illegal.

The front directional signals and the taillights will flash intermittently when the flashers are in operation. The hazard warning flashers will not operate when the service brake pedal is depressed. The turn signal will not operate when the flashers are on. When it is necessary to leave the vehicle, the flasher system will continue to operate with the ignition key removed.

IF YOU GET A FLAT TIRE

In case of sudden tire failure, avoid heavy brake application. Gradually decrease speed. Hold steering wheel firmly and move slowly to a safe, off-road place. Park on a level spot, turn off the ignition, and turn on the hazard flasher system.

SPARE TIRE STORAGE

Chevy & Ford Chassis:

The spare tire is located on the rear of the vehicle.

Model W/ICF429WQ (Wide Body) Only:

The spare tire is stored on a carrier assembly beneath the rear of the coach. Support the tire carrier with a jack or block while removing hairpin cotter and retainer nut, then lower carefully to the ground. Do not over-tighten the wing nut when returning the spare to the storage position.

WARNING

Do not lie beneath tire carrier while removing tire. The tire and carrier assembly are heavy.

MOTOR HOME JACKING AND TIRE CHANGING

Follow the chassis manufacturer's recommendations for jacking and tire changing. These instructions are found in the chassis operating guide in your Motor Home Operations Manual binder.

A jack is designed for use as a tool for changing tires only, not for use as a leveling device or as a support for service purposes.

TIRE CHANGING SAFETY PRECAUTIONS

Before attempting to change either the front or rear tires, the following precautions should be heeded:

1. Park vehicle on level surface only.
2. Turn off engine and set parking brake.
3. Activate hazard warning flasher.
4. Block both front and back of wheel opposite wheel to be removed.
5. On soft ground, use a board or other material under jack as a firm base to ensure that the jack will not shift.

WARNING

DO NOT crawl under the vehicle when it is supported by a jack.

IMPORTANT

When installing the outboard rear dual wheel and tire assembly, rotate the outer dual wheel so valve stems are accessible but not touching one another. In some cases this means that the inner and outer valve stems should be in separate wheel cutout locations.

NOTE: When installing or tightening dual wheels, both wheels on the same side must be off the ground (not resting on the inner dual). This minimizes the possibility of loose wheels after correct mounting torque is applied.

WHEEL NUTS

To properly seat the wheel nuts and to eliminate the possibility of the wheel nuts becoming loosened while driving, they should be tightened at frequent intervals to the torque

specified in your vehicle chassis manual. This is especially important during the first 100, 1,000 and 6,000 miles of operation after replacement of a wheel or wheel nuts.

WARNING

The operator is advised to obtain road service whenever possible and attempt tire changing under emergency conditions only and with close adherence to instructions. If it becomes necessary to change a wheel, that wheel should be checked, after being properly torqued and inspected by qualified service personnel, at 100 miles and every oil change thereafter.

Upon satisfactory completion of emergency tire change, it is highly recommended that the wheel nuts be properly torqued and inspected by qualified service personnel as soon as possible.

RECOVERY TOWING

See chassis operating guide for proper recovery towing procedures.

Winnebago Industries does not assume responsibility for damage incurred while towing this vehicle.

WARNING

Stay out from beneath the motor home while it is suspended by the towing assembly unless the vehicle is adequately supported by safety stands. Do not allow passengers to occupy a towed vehicle.

IMPORTANT

Know and obey all state and local towing regulations. Tow at reduced speed.

JUMP STARTING

WARNING

Automotive batteries produce caustic acid, explosive gases, and electrical current which may cause burns. It is important that the instructions below are followed exactly, or personal injury (particularly to eyes) or property damage may result due to battery explosion, battery acid, or electrical (short circuit) burns.

- NEVER smoke near the battery or expose it to open flame or electrical sparks.
- Wear eye protection or shield your eyes while working near either battery, in case an explosion does occur. NEVER lean over a battery.
- Do not allow battery fluid to contact eyes, skin, clothing, or painted surfaces. Immediately flush any contacted area with water. If eyes are affected seek medical help after flushing.
- Remove all metal jewelry to lessen the risk of a short circuit occurring.

Connecting Jumper Cables

1. Make sure that the other vehicle has a 12-volt battery and negative ground compatible with your vehicle's electrical system.
2. Position the vehicle with the good battery so that the jumper cables will reach, but **do not allow the vehicles to touch.**
3. Turn off all electrical accessories, motors, and lights except those required for safety or to illuminate the work area. Place automatic transmission in P (Park). Be sure parking brakes are engaged in both vehicles.
4. If the discharged battery has filler caps, make sure the electrolyte is at proper level. Add distilled water if fluid is low. If electrolyte is not visible or appears to be frozen - **do not attempt jump starting!** A battery may rupture or explode if the electrolyte is frozen or not filled to the proper level.
5. Connect one end of the positive "+" (red) jumper cable to the positive "+" terminal of the discharged battery. Connect the other end to the positive "+" terminal of the charged battery.
6. Connect one end of the negative "-" (black) jumper cable to the negative "-" terminal of the charged battery.

7. Finally, connect the remaining end of the negative "-" (black) cable to a solid, metal grounded location on the engine of the vehicle with the weak battery, at a point at least 18 inches from the battery.
Do not connect to any moving parts.
THE PRIMARY SAFETY PRECAUTION IS TO MAKE THE FINAL CONNECTION TO GROUND ON THE ENGINE AT A SAFE DISTANCE FROM THE BATTERY. THIS HELPS TO REDUCE THE CHANCE OF EXPLOSION DUE TO SPARKS.
8. Start the engine of the vehicle with the charged battery, and allow it to run for a few minutes at moderate r.p.m. Then start the engine of the vehicle with the discharged battery.
9. Reverse the above sequence EXACTLY when removing the jumper cables. Start by removing the cable from the ground location on the engine first, then continue in reverse sequence.

WARNING

Do not attempt to push-start this vehicle. Damage to the transmission or other parts of the vehicle could occur.

CONNECTING A BATTERY CHARGER

CAUTION

Disconnect the radio power leads before attaching a battery charger or jumper cables to the battery. The radio tuner may become damaged if this is not done.

To connect a battery charger, first make sure the engine is switched off. Disconnect the positive lead from the battery. Never disconnect the battery while the engine is running or alternator damage could result.

Connect the positive "+" (red) lead of the charger to the positive "+" terminal on the battery. Next, connect the negative "-" (black) lead of the charger to a suitable ground. Finally, plug in or switch on the charger.

To disconnect the charger after charging, unplug the charger from the electrical outlets, remove the charger leads from the vehicle, and reconnect the vehicle leads to the battery.

ENGINE OVERHEAT

If you see or hear steam escaping from the radiator or the engine compartment or have any other reason to suspect an extreme engine overheating condition, pull the vehicle over to the roadside as soon as it is safe to do so, stop the engine and get out of the vehicle.

WARNING

Operating a vehicle under a severe overheating condition can result in damage to the vehicle and may result in personal injury.

An engine will overheat if the coolant is low or there is a loss of coolant because of one or more of the following:

- a leak in the cooling system
- a hose failure
- a drive belt breaking
- water pump failure

Also, be aware of the following situations, which can cause temporary engine overheating:

- climbing a long hill on a hot day
- idling while stopped in traffic for long periods of time
- towing a trailer or automobile
- stopping after a period of high speed driving

If the TEMP indicator on the instrument panel shows a rise in engine coolant temperature while driving, take the following steps to attempt to lower the overheating condition:

- If you are using the automotive air conditioner, turn it off.
- If you are stopped in traffic, shift the transmission into P (Park), and engage parking brake.

If the temperature does not drop within a minute or two:

- Pull the vehicle over to the roadside as soon as it is safe to do so.
- Place the transmission in P (Park) and press the accelerator to increase engine speed (r.p.m.'s) to twice that of normal idle speed, and hold it there for approximately two or three minutes.
- If engine temperature does not go down, turn the engine off and wait until the engine has cooled before attempting to open the hood.

When no trace of escaping steam is heard or seen, open the hood to check for the cause of the overheat. Check hose connections and tighten if necessary. Make sure there are no broken belts, pulleys or hoses before adding any coolant to the radiator.

For further information in case of overheating, consult your chassis operating guide.

SECTION 4

TRAVELING WITH YOUR MOTOR HOME

(See also SAFETY PRECAUTIONS, Section 1 of this manual.)

LOADING THE VEHICLE

When loading the vehicle, distribute the cargo load equally so that you do not exceed either the Front or Rear Gross Axle Weight Rating (GAWR) or the Gross Vehicle Weight Rating (GVWR). Have your vehicle weighed to determine the proper load distribution for your vehicle. The GVWR is listed on the Vehicle Certification Label.

The total combined weight allowed for the vehicle, including trailer towing load weight, is known as the Gross Combined Weight Rating (GCWR). If trailer towing is not recommended, the GCWR will be equal to the GVWR.

Your cargo capacity will vary according to the options equipped on your vehicle, and your additional equipment and components not supplied with the vehicle. **Do not exceed** any of the recommended weight ratings.

NOTE: We recommend that you dump all holding tanks before traveling to avoid carrying unnecessary weight.

| CAUTION |
|--|
| The weight of the loaded vehicle (including options, attachments, passengers, water, fuel, luggage and all other cargo) must not exceed the GVWR or GAWR of either axle. |

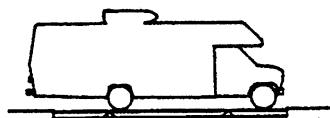

GVWR
(Both Axles)



Front GAWR
(Front Axle Only)

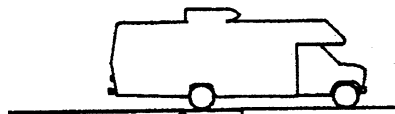

Rear GAWR
(Rear Axle Only)

Weighing Your Motor Home

We recommend that front suspension and steering alignment be checked and adjusted if necessary after you have fully loaded the vehicle according to your needs. Thereafter, alignment should be periodically inspected to maintain vehicle steering performance and to prevent uneven tire wear.

ROOF LOADING

The roof on most models is capable of carrying some lightweight articles while the vehicle is in motion. A roof-mounted luggage carrier designed for this purpose is available from your dealer. However, roof load while the vehicle is in motion is not to exceed 10 pounds per square foot or a maximum of 100 pounds.

When the vehicle is stationary, a cargo load of 100 pounds plus the weight of a 225 pound person to load the cargo or to conduct inspection and maintenance is permissible.

Weight added to both the roof and the trailer hitch contribute to the gross vehicle weight, which must not exceed the vehicle's GVWR.

TRAILER TOWING

The factory installed towing hitch on this coach is capable of pulling 3,500 lbs. (max.) and carrying 350 lbs. (max.) on the hitch ball. However, your coach's towing and hitch ball capacity may be less due to the coach's loaded weight and/or the towed vehicle's weight and hitch ball weight. The combined weight of the coach and the towed vehicle should not exceed the coach's Gross Combined Weight Rating (GCWR). Also, the combined weight of the coach and the towed vehicle's hitch ball weight should not exceed the coach's Gross Vehicle Weight Rating (GVWR) or its rear Gross Axle Weight Rating (GAWR) listed on the Vehicle Certification Label.

Because of individual vehicle use and loading habits, we recommend weighing the vehicle while fully loaded to avoid exceeding any of the listed Gross Weight Ratings. Refer to the illustration "Weighing Your Motor Home" at left. See "Vehicle Certification Label" for information on gross weight ratings.

Towing will affect handling, durability and economy. Exceeding any of the listed Gross Weight Ratings will result in unacceptable overall vehicle performance. Maximum safety and satisfaction when towing depends on proper use of correct equipment. A hitch bar of appropriate

steel and size should be selected to mate with the Winnebago Towing Receptor.

Installation of a proper trailer brake system is recommended. Check state regulations concerning trailer weight and trailer brake requirements to ensure selection of suitable equipment before attempting to tow.

Before descending a steep or long grade when towing a trailer, reduce speed and shift into a lower gear to control vehicle speed. Avoid prolonged or frequent application of brakes which could cause overheating.

WARNING

For safe towing and vehicle handling, maintain proper trailer weight distribution.

The total weight of the motor home and the vehicle towed must not exceed the Gross Combined Vehicle Weight rating. Contact the chassis manufacturer to obtain the Gross Combined Vehicle Weight rating for your chassis.

CAUTION

Exceeding any of the recommended gross vehicle weight ratings may result in vehicle damage.

Do not install a frame equalizing type hitch on your vehicle.

See also - Trailer Wiring Connector, page 6-6.

PRE-TRAVEL CHECK LIST

Before starting the engine to leave on a trip, be sure your motor home has been properly prepared and maintained. This will ensure an enjoyable trip and help avoid delays. Use this checklist as a guide.

- Fluid Levels - Check and fill if necessary:
 - engine oil
 - transmission
 - power steering
 - radiator
 - brake
 - battery
 - windshield washer.
- Wheel Lug Nuts - Check for tightness.
- Tires - Check for proper cold inflation pressures as specified on the Vehicle Certification Label.

- Drive Belts - Check for proper condition and tension (not cracked, frayed or loose, etc.).
- 110-Volt Generator (Optional) - Check oil level in generator engine.

WARNING

Never check oil level in generator while engine is operating.

- Fire Extinguisher - Make sure it is fully charged and secured in mounting bracket.
- Lights - Make sure all exterior lights operate.
- Sewer and Water Supply Hose - Unhook and store.
- TV Antenna - Make certain the TV antenna is lowered and seated in its support cradle.
- Loose Items Inside the Motor Home - Store or secure items.
- Pilot Lights - Make sure all pilots are off.
- Fuel Tanks - Check level.
- Water Tank - Fill with fresh water.
- Exterior Door and Step - Make sure doors are closed, locked and step retracted.
- Seats - Adjusted for comfortable position and locked in place.
- Mirrors - Adjust for maximum visibility from driver's seat.

EQUIPPING FOR TRAVEL

When beginning a trip, several items should be taken in addition to the basic clothes, food and recreational items. A checklist is provided for your convenience. Remember, it is important to distribute weight and store all heavy items near the floor.

EMERGENCY EQUIPMENT CHECKLIST

Flashlight
First Aid Kit
Road Emergency Flares
Tool Box with Assortment of Hand Tools
Plastic Bucket
Tow Chain or Rope
Wheel Blocks or Extra Jacks for leveling
Water Hose
100-150 Feet of 3-Wire Electrical Cord with at least 30 AMP Capacity
Fire Extinguisher
Hydraulic Jack and Lug Wrench
Spare Tire

QUICK LOADING CHECKLIST

BEDDING

- Sleeping Bags
- Sheets
- Pillow Cases and Pillows
- Mattress Pads
- Extra Blankets
- Laundry Bags

COOKING

- Can Opener
- Bottle Opener
- Aluminum Foil
- Matches
- Plastic Bags
- Coffee Pot
- Storage Dishes

CLEANING

- Scouring Pads
- Cleanser
- Glass Cleaner
- Dish Soap
- Sponge
- Laundry Soap
- Cleaning Rags or Paper Towels
- Garbage Bags

BATHROOM

- Bath/Hand Soap
- Bath Towels that can double as beach towels
- Toiletry Kits
- Toothbrushes and toothpaste
- Shaver/Razors
- Toilet Tissue (RV)

BABY NEEDS

- Car Seat (Child Restraint)
- Portable-Crib
- Play Pen

PERSONAL

- Credit Card(s)
- Traveler's Checks
- Money
- Driver's License
- Proof of Citizenship (for Canadian or Mexican crossing)
- Sunglasses

PET NEEDS

- Food
- Leash
- Water and Food Dishes
- Proof of Rabies Shot

MISCELLANEOUS

- String
- Clothesline
- Insect Repellent
- Masking Tape

TRAVEL TIPS

As you travel around the country in your motor home, you will pick up useful advice from other motor home owners.

A number of suggestions can also be obtained by reading articles and regular columns in camping magazines. Some magazines and publishing companies print an annual park and campground directory. These can be found at your local newsstand or RV supply dealer. Here are a few travel tips to begin with.

1. Always check for sufficient clearance. Remember the height and width of your unit.
2. Always fill your fresh water tank at an approved potable water filling facility or at a known purified water source. Taste the water before filling the water tank in an unfamiliar location. The water in some areas may contain an undesirable taste. Do not use a new hose to fill the water tank. It can leave a distinct rubber or vinyl taste.
3. Showers can take a lot of water. Conserve water by taking a "Sea Shower". This is done by: wetting down, turning off the water, soaping thoroughly and then rinsing.
4. Dump sewage only at approved dumping stations.
5. Store liquids in plastic containers with tight fitting caps to prevent spills.
6. Keep an eye on the water and holding tank levels. It is a good idea to dump the holding tank at least every two days.
7. When traveling with children, it is helpful to plan their wardrobe for a week. Place each days clothing in a plastic bag and label the bag with the child's name and day of the week for use.
8. Use sleeping bags whenever possible. They save laundry and take up less storage space than bedding.
9. Make sure all compartment doors have been closed and the door step has been stowed in the correct position before moving the vehicle.
10. Before traveling, make sure the refrigerator door has been secured. Use care when opening the refrigerator door after the vehicle has been stopped. Any articles that have shifted may fall out when the door is opened.
11. During peak tourist season and holidays, it is best to phone ahead and make reservations at the park where you plan to stop.

12. Some states or cities will not permit vehicles with LP gas containers to pass through highway tunnels. If your route includes a tunnel, check with the highway patrol or department of highways to avoid inconvenience.
13. Do not leave food or odor-causing material in your vehicle for extensive periods of time. Always allow damp clothing, swimwear, hunting gear, etc., to dry before stowing.
14. Become familiar with the fire extinguisher and make sure it is always fully charged. Remove and replace it and read instructions so you know the correct operating procedure before an emergency happens.
15. Make a list of all groceries, fresh meats, vegetables, newspapers, etc., that you may need and try to pick them up during your last fuel stop of the day. This will prevent leaving a good parking spot once you have arrived at your destination.
16. When you sit over the front wheels while driving, as in a motor home, you have a tendency to crowd the middle of the road. Check the side view mirror frequently to observe how close you are driving to the center line.

HUMIDITY AND CONDENSATION

Fogging may appear on the windows when there is excessive humidity inside the coach. In extremely cold weather this can become frost or even ice. To help reduce excess moisture, partially open a window or roof vent. Operating the range hood vent or powered roof vents will also help.

SEVERE WEATHER INFORMATION

One of the more serious conditions affecting the motor home traveler and camper is that of the weather. Whether you desire the high mountain terrain, the lower deserts and flatlands or the plains of the midwest, the weather is always with you and subject to change, sometime with little or no warning. However, adequate warnings are normally broadcast over local radio and TV stations.

Motor home travelers and campers often seek secluded areas for weekend recreation or extended summer vacations. Many recreational areas are vulnerable to severe weather situations, especially flash flooding conditions. A few simple precautions may help lessen the hazards of flash flooding or reduce your immediate involvement.

IMPORTANT

We recommend that all motor home occupants become familiar with these safety precautions, and be constantly alert to changes in weather.

- Be alert, keep an eye to the sky because thunderstorms can form at any time in any month of the year. Thunderstorms can produce heavy amounts of rain over a small area in a short time which may result in a flash flood. Listen frequently to weather reports on radio for weather and flood conditions.
- When camping near a stream, leave plenty of sloping bank between you and the stream.
- Avoid deep canyons and dry washes during stormy or threatening weather. Be aware of alternate exits.
- If heavy rain occurs, move to high ground immediately (at least 30-40 feet above the canyon floor or bottom of dry wash).
- During a flash flood, if you can't move your vehicle, abandon it. Don't attempt to return to your vehicle before the water has receded.
- Don't attempt to wade to your vehicle if the water is above your knees - fast moving water exerts an enormous amount of pressure, making it impossible to remain standing or walking.
- Don't try to drive through flooded areas.
- Follow instructions of local authorities. Leave immediately when advised to do so. Many lives have been lost because people didn't heed warnings.
- Have on hand survival supplies for several days, including food, water, first aid equipment and necessary medications. In desert areas during hot weather allow 3-4 gallons of drinking water per person, per day.
- Before you leave home, inform someone of your destination and when you expect to return. Authorities at your destination should be notified immediately if you do not return on time.

REMEMBER THESE TERMS:

WATCH: Severe weather may develop in the specified area. Be alert and prepare for possibility of an emergency.

WARNING: Severe weather is occurring, or is imminent in certain areas. Move to a safe location immediately.

We highly recommend that the motor home operator obtain a weather radio. These radios offer up-to-date weather condition broadcasts. During good weather, the latest information and forecasts are tape-recorded by local National Weather Service offices in messages that last from three to five minutes. These messages are replayed continually 24 hours a day. The recorded messages are revised every three to four hours, or more frequently when appropriate.

When severe weather threatens, forecasters at the local National Weather Service office interrupt the broadcasts with storm warnings, either recorded or "live" as the situation demands.

The frequencies used for NOAA Weather Radio (National Oceanic and Atmospheric Administration) nationwide are 162.40, 162.475 or 162.55 megahertz.

NIGHTTIME DRIVING

- Make sure all running lights and signal lights are clean and in working order. Have your headlights periodically checked and adjusted.
- Use care when passing other vehicles. Automobile drivers can easily tell when they are clear of a vehicle they are passing. However, drivers of long vehicles, such as your motor home, may have a more difficult time making that judgement. If possible, have another person in the coach help you watch while passing another vehicle and when in heavy traffic.

MOUNTAIN DRIVING

Special techniques must be used when driving in mountainous or hilly country. When ascending upgrades the transmission will automatically drop into a lower gear. If the grade of the incline is constantly changing and the automatic transmission is repeatedly upshifting and downshifting, select the lowest adequate gear range for the duration of the incline.

CAUTION

Observe the engine temperature gauge more frequently than normal. If overheating occurs, pull off to the side of the road and allow the engine to thoroughly cool before refilling the radiator and restarting the engine.

CAMPSITE SET-UP

Try to pick as level a spot as possible on which to park your motor home.

Leveling the motor home is very important, not only for your comfort, but for plumbing and appliances as well. Some refrigerators are extremely sensitive to being unlevel. The ammonia vapor cooling system used in most RV refrigerators can "lock up" and damage the refrigerator if it is not level. This is both inconvenient and costly. Also, water and holding tank level indicators may give false readings because water level is greater at one side of the tank than the other.

A motor home can be leveled using several methods including sophisticated electronic-hydraulic systems. The most common and inexpensive method, however, is to use wooden blocking under the downside wheels.

Blocking

You will need:

Blocks - an assortment of wooden blocks and planking to stack and drive the lower wheel(s) onto.

Jacks - to place under the frame to make the floor solid, not moving on the suspension springs. Inexpensive mechanical or hydraulic ("bottle") jacks work fine. These are not intended to lift the vehicle; only to hold it steady. We do not recommend lifting any of the wheels off the ground for leveling. This could cause the vehicle to roll off the jacks possibly resulting in damage to the vehicle.

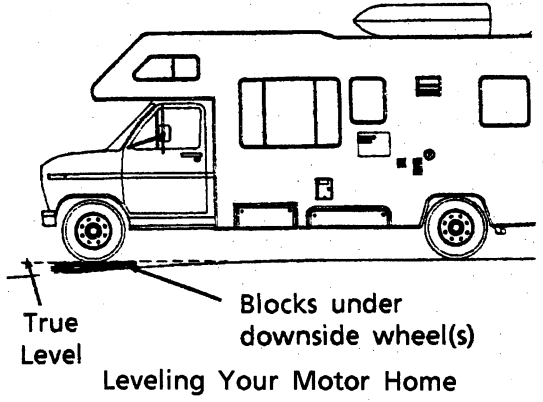

SECTION 5

LP GAS SYSTEM

(See also Safety Precautions, Section 1 of this manual.)

LP GAS SUPPLY

The LP gas system supplies fuel for the range, water heater, furnace and refrigerator (while in gas mode). When used and handled properly, this system is safe and economical and provides modern living conveniences wherever you travel.

SAFE USE OF THE LP GAS SYSTEM

- Exercise caution at all times. Be familiar with the distinctive odor of LP gas. If a leak is suspected, turn off the supply valve immediately. Have the LP gas system checked by your dealer or a qualified LP gas service center.
- Do not tamper with the LP gas piping system, pressure regulator or gas appliances. Service and maintenance of LP gas system components should be performed only by your dealer or a qualified LP gas service center.
- Never attempt to connect natural gas to the LP gas system.
- Have the entire LP gas system inspected for possible leaks and missing or damaged parts at each tank filling. Also inspect before and after each trip, and any time trouble is suspected.
- Turn the LP supply valve off when not using the LP gas system.
- Never use a wrench to tighten the tank supply valve. It is designed to close leak-tight by hand. If a wrench is required to completely close the valve, it is defective and must be replaced.
- Never allow the tank to be filled above the 80 percent level indicated by the flow of liquid gas out of the overflow valve or by the automatic stop-fill device.
- Be sure appliance and outside vents are open and free from obstruction when using the LP gas system.
- Never attach a lock or any device requiring a key to the LP tank compartment door. According to standards set for recreation vehicles, the LP supply valve must be readily accessible in an emergency.
- Exercise caution when drilling holes or attaching objects to the walls. Gas lines and electrical wiring could be seriously damaged and present an extreme safety hazard.

How LP Gas Works

LP (Liquified Petroleum) gas is a true gas compressed into liquid form for easy transportation and storage. It is known by several names such as tank gas, bottled gas or simply as butane or propane, which are the two types of LP available.

LP is used by appliances in vapor form only, but is stored in the tank as a liquid under very high pressure. As the liquid gas is released, it reverts back to a vapor and expands to many times its compressed volume.

SELECTING FUEL TYPES

Butane burns hotter than propane, but will not develop a usable gas vapor at temperatures lower than 32° F. Propane, on the other hand, does not burn as hot but will convert to usable gas at temperatures down to -44° F. For this reason, propane is popular in cold climates, while butane and propane/butane mixtures are used most widely in milder climates.

IMPORTANT

Most LP dealers normally handle only the type of LP gas commonly used in their climate and area. If you anticipate filling your tank in one of the warmer states prior to traveling to a colder area, it is advisable to request propane only. Otherwise your LP system may fail to operate if the temperature drops below 32° F.

Each gallon of liquid LP gas contains approximately 92,000 BTU's of heat energy; or putting it another way, each gallon of LP gas produces approximately 36.2 cubic feet of dry gas for cooking, heating, water heating and refrigeration.

To find out how long a gallon of LP gas will last, you should determine the total BTU input on all your LP gas appliances in use. Let's say you have a heater that has a 10,000 BTU input per hour of operation. A gallon of LP gas would last 9.2 hours of continuous operation (92,000 divided by 10,000 = 9.2). To estimate how long a gallon of LP gas lasts, try to determine what your total daily BTU input is, then divide into 92,000 to arrive at an approximate daily LP gas consumption.

LP TANK SYSTEM

The storage reservoir for the LP gas system is a horizontally mounted tank which is permanently attached to the vehicle frame. The tank is accessible only from the outside of the vehicle. The tank supply valve is located near the top center of the tank, next to the regulator. Before opening the supply valve, check to be sure all controls for gas appliances are in the "Off" or "Pilot Off" position. If this step is not performed, LP gas could accumulate inside the motor home creating a fire or explosion hazard.

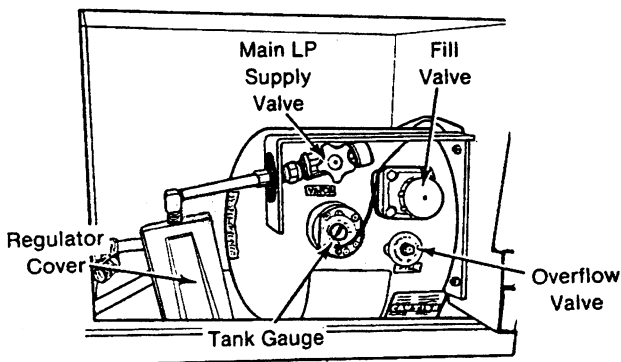

Typical LP Gas System Controls

REFILLING LP TANK

There are many LP gas refueling stations located throughout the country. These stations are listed in the telephone directory Yellow Pages under "Gas - Liquefied Petroleum - Bottled and Bulk."

Since the LP tank is permanently mounted to the frame, the motor home must be taken to an LP dealership for filling. Do not attempt to remove the LP tank from the vehicle. The tank is equipped with a fill adapter with both internal and external threads which allows easy filling with any LP filling equipment. The tank is full when liquid LP gas appears at the overflow valve.

NOTE: The LP tank is equipped with an automatic 80% stop-fill device.

AIR IN THE LP GAS TANK

If your LP gas appliances do not stay lit or require frequent adjustment, even though you know the LP tank contains sufficient fuel, the problem may be air in the LP gas tank. Air in the tank mixes with the LP gas vapors causing them to burn poorly. This condition could linger for weeks

if the air is not purged from the tank. Most LP gas dealers have equipment for purging air from LP gas tanks and will purge before refilling the tank.

TRAVEL WITH LP GAS

It is illegal for vehicles equipped with LP tanks to travel on certain roadways or through certain tunnels in the U.S. To avoid inconvenience, check state regulations concerning flammable gas transportation.

WARNING

Do not alter or remove LP tank gauge at any time.

WARNING

DO NOT FILL CONTAINER TO MORE THAN 80 PERCENT OF CAPACITY. Make sure the motor home is level when filling. It is possible to accidentally overfill the tank if the vehicle is unlevel, especially if the fill valve is on the uphill side. Overfilling the LP gas container can result in uncontrolled gas flow which can cause fire or explosion. A properly filled container will contain approximately 80 percent of its volume as liquid LP gas.

All pilot lights must be extinguished and supply valve closed before refilling LP gas tanks or vehicle fuel tanks.

Do not smoke or expose an open flame while near an LP refueling area. LP gas is heavier-than-air and extremely flammable.

Never use an open flame to test for LP gas leaks.

Replace all protective covers and caps on LP system after filling.

Never fill the LP tank with engine or generator running.

REGULATOR

The pressure regulator is protected from the elements by a plastic cover which should be left in place at all times. Only your dealer or a qualified LP gas service should remove the regulator cover for adjustments.

WARNING

Inspect the pressure regulator vent hole periodically for blockage. If any obstruction is apparent, have the regulator serviced by your dealer or a qualified LP gas service center.

LP gas regulators are installed with the diaphragm vent facing downward. Make sure that the regulator vent always faces downward to minimize vent obstruction which could result in excessive pressure, causing a fire or explosion.

Regulator freeze-ups are caused by the presence of moisture in fuel. This moisture will pass through the cylinder valve and into the regulator where it can freeze. Fuel producers, tank and bottle manufacturers and LP gas dealers take every precaution to reduce moisture, but sometimes only a fraction of an ounce entering the tank can cause problems. To help avoid the possibility of freeze-up, always keep tank control valve closed when not in use, even when tank is empty, to prevent moisture from collecting on the inside.

If regulator freeze-up should occur, you may attempt to thaw the regulator using a light bulb. **DO NOT USE AN OPEN FLAME OR HEAT LAMP.**

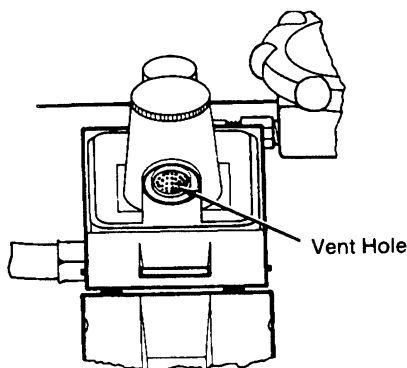

LPG PRESSURE REGULATOR
(Typical)

If moisture begins to cause problems, have your LP gas dealer inject a small amount of dry methyl alcohol in your tank (approximately one ounce to 20 pounds or one pint to 100 gallons) to help guard against regulator freeze-ups.

In very cold weather when a large volume of gas is being used for heating, it is possible to experience a loss of gas pressure. At first, this problem may appear to be caused by a regulator freeze-up, but is actually caused by failure of the

liquid gas to vaporize as fast as it is needed. As the temperature becomes colder, it is increasingly harder for the liquid LP gas to "boil-off" into a vapor. At the same time, the demand for LP to produce heat increases to the point where the system cannot maintain production.

The only actual solution to this problem is to reduce the consumption of gas where possible. Adjusting the temperature on the gas/electric refrigerator may be a first step. Using less hot water will help as well.

LP GAS LEAKS

The following label has been placed in the vehicle near the range area. If you smell gas within the vehicle, quickly and carefully perform the procedures listed.

IF YOU SMELL GAS

1. Extinguish any open flames, pilot lights and all smoking materials.
2. Do not touch electrical switches.
3. Shut off the gas supply at the tank valve(s) or gas supply connection.
4. Open doors and other ventilating openings.
5. Leave the area until odor clears.
6. Have the gas system checked and leakage source corrected before using again.

LP GAS ALARM - See page 1-2.

WINTER USE OF LP GAS

Due to vaporization characteristics of LP gas, it is important that the winter camper knows how to most efficiently use the LP system. The vaporization rate of LP gas decreases in a direct relationship to a decrease in temperature. As explained in the "Selecting Fuel Types" section, butane does not vaporize below 32° F, so propane must always be used in cold climates. However, even propane vaporizes at a slower rate as it becomes colder.

The greater the amount of liquid gas in the tank (up to the 80% level) the greater the amount of LP gas vapor generated. The following is an example of the number of BTU's available from an 84-pound tank at 0° F at three levels. As you can see, the number of BTU's decreases as the tank is emptied. Nearly twice as many BTU's are available from a full tank than one that is one-fourth full.

BTU's Available at 0° F.

| <u>Tank Level</u> | <u>BTU's</u> |
|-------------------|--------------|
| 80% | 64,400 |
| 50% | 50,400 |
| 20% | 33,000 |

The following LP Gas Vaporization and Temperature Relationship chart typifies the LP gas loss with a decrease in temperature. The percentage figures are the increase or decrease of vapor that would be available at 0° F. These figures apply to any size LP gas tanks.

| <u>Temperature</u> | <u>Percentage of BTU's Available at 0° F.</u> |
|--------------------|---|
| 20° F. | 200% |
| 10° F. | 150% |
| 0° F. | 100% |
| -5° F. | 75% |
| -10° F. | 50% |
| -15° F. | 25% |
| -20° F. | 12 1/2% |
| -44° F. | Propane will not vaporize |

WARNING

Make sure the filling attendant uses the 80% overflow valve when filling the tank. A tank should never be filled above the 80% level to allow for vaporization and liquid expansion.

Do not place LP gas containers inside the vehicle. LP gas containers are equipped with safety devices which relieve excessive pressure by discharging gas to the atmosphere.

Do not place LP gas containers, gasoline, or other flammable liquids inside the vehicle. Fire or explosion may result.

SECTION 6

ELECTRICAL SYSTEMS

(See also Safety Precautions, Section 1 of this manual.)

Your motor home is equipped with an electrical system consisting of two separate voltages: a 12-volt DC system and a 110-volt AC system. The 12-volt system consists of two internal power sources, while the 110-volt system is operated from an outside power source or the optional 110-volt generator. All systems operate through a single power converter control center to provide electrical power to the motor home.

110-VOLT AC SYSTEM

The 110-Volt system operates from an outside 110-volt utility service such as those at campgrounds, or from the optional 110-volt generator. When the power cord is connected to an outside power source, or when the generator is in operation, the power converter automatically changes a portion of the 110-volt current to 12-volt DC current. All equipment in the motor home that is normally powered by the auxiliary battery is then powered through the converter.

In addition, the following equipment is entirely dependent on the 110-volt generator or outside source: roof air conditioner, refrigerator (when placed in 110-volt mode), microwave oven, ice maker, vacuum cleaner and other 110-volt electrical equipment used at convenience outlets.

EXTERNAL POWER CORD (Shoreline)

The external utility power cord (commonly referred to as a "shoreline") is stored in a compartment located on the left side of the motor home.

WARNING

Do not connect the external power cord to any receptacle until you have contacted the owner and/or attendant of the premises to verify proper polarity and grounding.

It is the responsibility of the owner of the electrical receptacle to ensure that the receptacle is properly wired and grounded.

Reverse polarity and improper grounding of the vehicle can cause personal injury or death.

To connect to an external power source, remove the cord from the storage compartment and plug it into a suitable power receptacle.

A small "hatch" provided in the compartment door allows the door to be closed while the cord is attached to an external source.

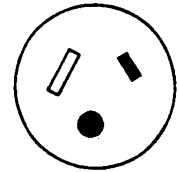

30 Amp Receptacle

The three-prong power cord is designed to ground the electrical system through the receptacle. It is also designed to carry the amperage output of most campground outlets. If the electrical receptacle to be used is designed to mate with the three prongs on the power cord plug, the electrical connection can be expected to carry rated load.

Should an overload on an appliance occur due to an excessive amperage draw, a circuit breaker for that appliance will trip.

WARNING

Do not plug the power cord into an outlet which is not grounded, or adapt the plug to connect to a receptacle for which it is not designed.

Be sure that all three prongs of the supply cord are properly plugged into the receptacle.

Do not connect the power cord to an extension cord.

Do not plug the power cord into the generator receptacle while the generator is running.

Most campgrounds are equipped with a fuse or circuit breaker at the receptacle. This protects the park's wiring, as well as the power cord on your vehicle, from electrical damage. If electrical power fails, contact the park attendants and have them check the fuse or breaker for your supply receptacle.

When disconnecting the power cord, neatly replace it in the storage compartment.

POWER CONTROL CENTER (Converter)

The power converter changes 110-volt AC current from the auxiliary generator or the shoreline into 12-volt DC current for use by 12-volt equipment in the motor home.

Certain circuits, however, remain unchanged for use by items which require 110-volt current, such as the air conditioner(s), the refrigerator in AC mode, the microwave oven, etc.

Current drawn from the coach batteries passes through the power center unchanged, although it is routed through a series of protective fuses located on the power panel.

The converter is located in a lower cabinet face in the galley, living area or beneath a bed. The converter power panel contains the coach electrical system 110-volt circuit breakers and 12-volt fuses.

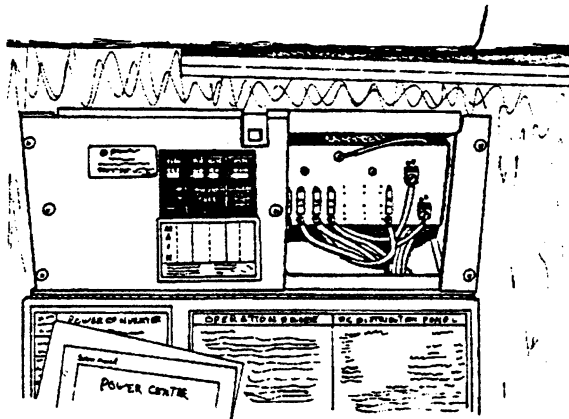

Power Converter

WARNING

Do not store anything around or on top of the converter, or in front of the cover. The converter generates heat while operating, and needs unrestricted air flow for proper cooling.

Charging Section

The converter charges coach batteries while 110-volt external power is connected. The converter will automatically "sense" the condition of the RV battery. If it is below "full charge", the Charging Section will start charging the battery.

If the coach batteries have been extremely discharged, they will accept charge at a relatively high amperage rate. If they are only slightly discharged, they will charge at a lower amperage rate. The rate of charge will decrease as the

batteries reach "full charge". Active charging will not resume until batteries again fall below "full charge". The converter will not overcharge the batteries. If your storage battery does not charge as described above, it is possible the battery is defective.

THERMAL BREAKER

A protective thermal breaker will "break" the 110-volt AC power to the converter section of Power Center if the power converter becomes overheated. This can result from operating above its maximum limit for an extended period of time or by obstruction of ventilation to unit.

NOTE: Power converter section will automatically route 12-volt lights and motors to battery power in this event.

The thermal breaker will reset itself after a period of time, and the lights and motors will again resume operation from power converter section. If the breaker trips again shortly after reset, take immediate steps to correct cause of overheating. A portion of RV 12-volt load (lights or motors or both) should be turned off to reduce total load. Also, inspect power converter section to make certain ventilation is not obstructed.

IMPORTANT

The converter will not change 12-volt DC current to 110-volt AC.

110-VOLT CIRCUIT BREAKERS

The breaker panel protects all 110-volt components in the motor home from either an overload on the circuit or a short in the wiring or component itself. When an overload or short develops, the breaker will open preventing any further flow of electricity and, therefore, damage to the system.

Shut off the equipment (example: roof air conditioner) and allow a brief cooling period. Then reset the breaker by moving the switch to "Off" and back to "On". If the breaker is continually tripped and no overload is evident, have the system checked for a short in the wiring or the appliances.

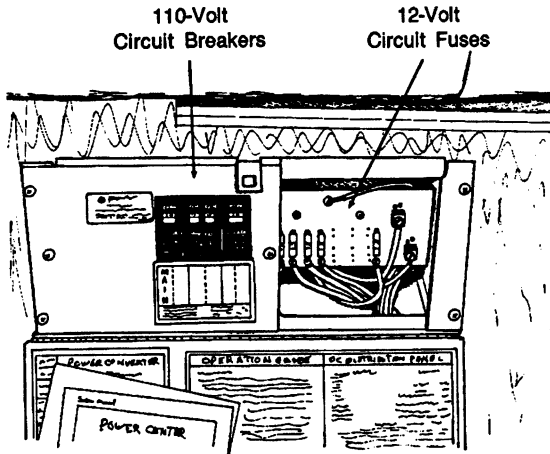

110-VOLT RECEPTACLES (Outlets)

A number of standard AC electrical outlets are provided throughout the coach for connecting small appliances such as televisions, radios, toasters, etc. Exterior outlets are also located on the outside of the coach near the entrance door, or in an exterior compartment.

GROUND FAULT CIRCUIT INTERRUPTER

Exterior, bath and galley outlets are connected to a GFCI (Ground Fault Circuit Interrupter), which is an extremely sensitive circuit breaker that will help to protect against severe electrical shock if a ground fault develops. If such a condition occurs, the GFCI will break the circuit by turning off the power to the protected outlet(s). Should this occur, unplug all the appliances on that circuit and press the reset button on the GFCI equipped outlet.

If the GFCI keeps tripping, have the electrical system checked and repaired if necessary before using again.

The GFCI outlet is located in the bath, bedroom or dinette area, depending on the floor plan of the vehicle.

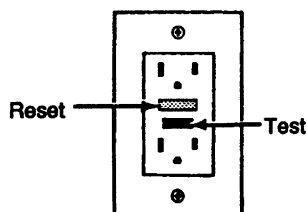

WARNING

The GFCI will not completely eliminate electrical shock. Small children and persons with heart conditions or other disabilities which make them especially sensitive to electrical shock may still be injured by a 110-volt receptacles even though protected by a Ground Fault interrupter.

NOTE: The galley outlet in Canadian equipped units is not GFCI protected.

AUXILIARY 110-VOLT GENERATOR

Optional

Consult the manufacturer's information provided in your Motor Home Operation Manual binder for instructions on operation, troubleshooting and maintenance.

WARNING

Careless handling of the generator and electrical components can be fatal.

Never touch electrical leads or appliances when your hands are wet, or when standing in water or on wet ground.

Do not attempt to repair the generator yourself. Service should be performed by an authorized service center.

Do not plug the power cord into the generator receptacle while the generator is running.

To use the 110-volt generator, plug the power cord into the generator receptacle within the shoreline compartment.

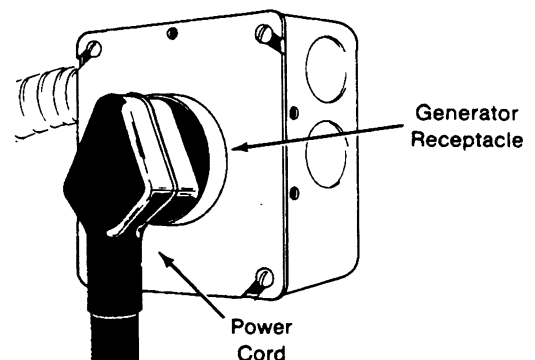

STARTING THE GENERATOR

1. Turn the Auxiliary Battery Disconnect Switch on (if equipped) to connect power to the generator starter motor.
2. Press the generator switch (on the range hood) into the ON position and hold until the engine is running. The switch must be held in position for several seconds after the generator has started to allow the generator to reach full operating voltage.

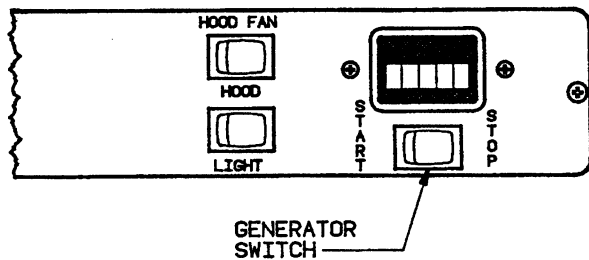

3. Allow the generator to stabilize by running 3 to 5 minutes before turning on appliances.
4. Apply electrical loads. Refer to SPECIFICATIONS section of generator manual for generator set output and performance ratings. Then refer to the chart below to aid in determining appliance usage during generator operation.

CAUTION

Continuous generator overloading can cause high operating temperatures that can damage the generator windings. Keep the electrical loads within the generator wattage rating.

**APPROXIMATE POWER REQUIREMENTS OF
COMMON APPLIANCES**

| Appliance or Tool | Approximate Power Consumption (Watts/Amps) |
|-----------------------|---|
| Vacuum cleaner | 200-500W/1.7-4.3A |
| Coffee maker | 550-700W/4.8-6.1A |
| Hair dryer | 800-1500W/7.0-13.0A |
| Electric iron..... | 500-1200W/4.3-10.4A |
| Electric blanket..... | 50-200W/0.4-1.7A |
| Television..... | 80-100W/0.7A |
| Electric drill..... | 250-750W/2.2-6.5A |
| Air conditioner..... | 1400-2000W/13-19A |
| Converter..... | 300-500W/2.6-4.3A |
| Microwave oven..... | 700-1500W/6.0-13.0A |

STOPPING THE GENERATOR

1. Shut off electrical equipment to remove load. Allow generator to run for 3 to 5 minutes to cool down.
2. Press the generator switch into the OFF position and hold until the generator comes to a complete halt.

GENERATOR HOURMETER (If Equipped)

This meter is located on the range hood. It registers the total number of hours that the generator has been operated. Refer to the hourmeter often to determine when periodic maintenance is due and to record services which have been performed.

NOTE: While the generator is running it is normal for the hourmeter to make a periodic "clicking" sound.

Operation Warnings and Cautions

WARNING

The exhaust of all internal combustion engines contains carbon monoxide (CO). This gas is colorless, odorless, tasteless, lighter than air and poisonous. The exhaust systems of both your motor home engine and your generator engine have been installed with your safety in mind. However, certain precautions must be taken in their use to protect you from conditions beyond the control of the manufacturer.

1. **Do not** simultaneously operate the generator engine and a ventilator which could draw air into the vehicle, resulting in the entry of exhaust gases.
2. **Do not** open windows or ventilators on the end or side of the vehicle where exhaust of the generator is located.
3. **Park** the vehicle so that the wind will carry the exhaust away from the vehicle. Also, note the position of other vehicles.
4. **Do not** operate the generator engine when parked if vegetation, snow, buildings, vehicles, or any other object can deflect the exhaust under or into the vehicle.

Check auxiliary generator oil level frequently during periods of use. Refer to the generator manufacturer's information in your Motor Home Operations Manual binder for specific recommendations.

WARNING

Never check generator oil level while generator engine is running.

12-VOLT DC SYSTEM

The DC voltage system consists of the automotive battery and the 12-volt motor home auxiliary batteries.

AUTOMOTIVE (Starting) BATTERY

The automotive battery is used solely to operate the engine starter and all automotive accessories and controls found on the instrument panel. This includes the horn, speed control, all exterior lights, radio, windshield wipers, rear auto heater fan, etc.

COACH BATTERIES

The auxiliary batteries supply current to 12-volt equipment located in the living area of the motor home. This includes: interior lights, range exhaust fan, furnace fan, water pump, water level and holding tank gauges, 110-volt generator starting, refrigerator, and bath roof vent fan. In addition, the auxiliary battery may be used to start the engine if for some reason the automotive battery is dead; refer to "Aux. Start Switch."

The coach batteries are automatically charged by the engine alternator while the engine is running.

12-VOLT FUSES AND CIRCUIT BREAKERS

All 12-volt circuits and equipment in the coach area of the motor home are protected by a fuse panel or breaker panel. When a circuit is overloaded or a short develops in any part of the system, a fuse or breaker will shut down that circuit. If this happens, turn off all affected lights or appliances and reset the breaker or replace the fuse with a new one of equal amperage rating.

A label on the panel states the amperage rating and circuit protected for each fuse or breaker.

A 12-volt circuit breaker is located in the auxiliary battery compartment. They control power supply to the Aux. Start switch and coach breaker panel.

If all 12-volt equipment is inoperable, check the breaker marked "Coach Breaker Panel". If the breaker is not tripped, the battery may be dead.

FUSE PANEL

The fuse panel is mounted on the right-hand side of the power converter.

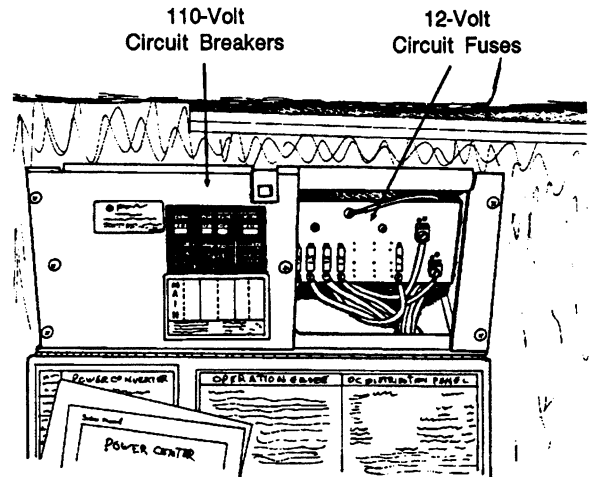

The fuse panel accepts only blade type plug-in fuses. Always replace fuses with those of the same amperage rating.

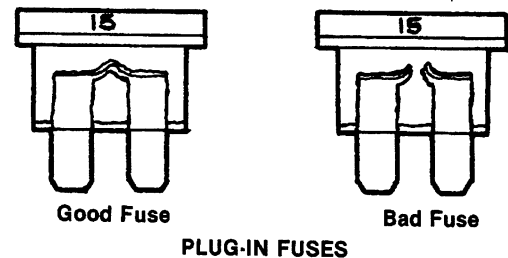

BATTERY INFORMATION

AUTOMOTIVE BATTERY ACCESS

The automotive (starting) battery is located in the engine compartment.

AUXILIARY (COACH) BATTERY ACCESS

The auxiliary battery is located in an exterior battery storage compartment for convenient access for periodic inspection or maintenance.

To service or remove the batteries, unfasten the retainer strap and disconnect battery cables.

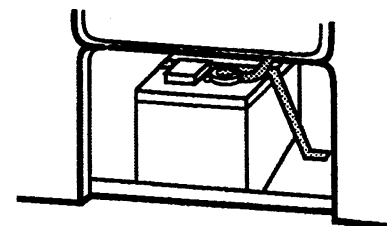

WARNING

Refasten the retainer strap when returning the battery to the compartment.

BATTERY MAINTENANCE

A battery is only a storage reservoir, not a source of electricity. As soon as energy is removed from the battery, it should be replaced by the alternator or converter system. If a battery is left in a discharged state without being recharged for long periods of time (30 to 90 days), it will sulfate and lose charging capacity. To ensure that the battery will always accept and hold a charge, some minor maintenance practices should be followed.

Make sure that batteries always remain securely clamped in the battery tray and the cable clamps are tight on the terminal posts and free of corrosion. Any corrosion buildup on the battery may be neutralized by washing with a solution of baking soda and water, and then rinsing with clear water.

IMPORTANT

Make sure vent caps are on securely to prevent baking soda solution from entering the battery and contaminating electrolyte fluid.

WARNING

Before removing any battery cables or battery, make sure all 12-volt equipment in the motor home is off and the power cord has been disconnected.

Replace any damaged cables at once.

Always remove jewelry and wear protective clothing and eye covering when checking or handling batteries.

Refasten the retainer strap when returning the battery to the compartment.

Clean and tighten battery terminals and have the specific gravity checked at least once a year. Every two months, or more often in hot weather, check the battery fluid level. Fill to approximately 3/8 inch above the plates. **DO NOT OVERFILL.** If fluid is added during freezing weather, the motor home should be driven several miles to mix water

and electrolyte to prevent freezing. Fluid level check may be omitted if equipped with maintenance-free batteries.

WARNING

To prevent damage to batteries or wiring, always observe battery polarity. Always attach positive (+) cable to positive terminal and negative (-) cable to negative terminal. The battery terminals are marked positive (+) and negative (-).

Disconnect both battery cables before connecting a "booster" battery charger to a battery inside the battery compartment.

Never try to charge or boost a frozen battery. A battery explosion could result.

BATTERY CONDITION METER

This meter allows you to check the level of charge in the coach battery in your motor home. It is located on the monitor panel in the galley area. (See Section 8.)

To obtain an accurate reading:

1. Both the automotive engine and the auxiliary generator engine must be stopped.
2. An interior light should be turned on to provide a small load which draws off battery surface charge.

AUX. START SWITCH - See page 2-7.

TRAILER WIRING CONNECTOR

Your coach is pre-wired for trailer or car towing lights with a 6-pin socket on the rear bumper. The connector plug is supplied in the coach parts package provided to you by your dealer when you took delivery of the vehicle.

The diagram below shows proper connection of trailer or tow vehicle wiring to the coach light system. Remove the small screw near the end of the plug and slide the contact assembly out of the barrel.

- TM = Tail lights
- GR = Ground
- LT = Left turn/Brake lights
- RT = Right turn/Brake lights
- S = Not used
- A = Backup lights

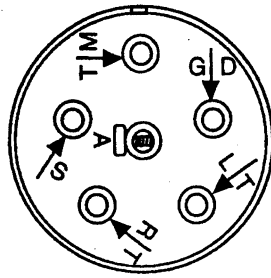

SECTION 7

PLUMBING SYSTEMS

FRESH WATER SYSTEM

The fresh water system provides water to the galley sink, shower, bathroom lavatory, toilet and water heater. Water may be supplied by either of two sources:

- a water tank located within the motor home, or
- any external water source to which the motor home may be connected, known as "city water".

FRESH WATER TANK FILLING PROCEDURES:

Always fill your fresh water tank at an approved potable water filling facility or at a known purified water source.

The tank may be filled by inserting a hose into the tank fill opening. A built-in vent prevents the tank from becoming air-locked while filling.

When neither city water nor a hydrant are available, a bucket and funnel may be used, although this can take a considerable amount of time.

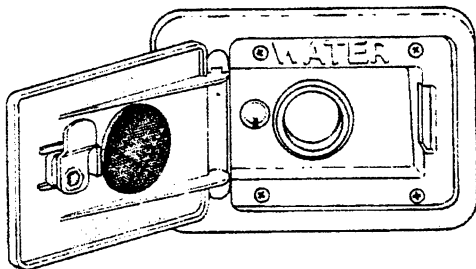

Water Tank Fill

Fresh Water Tank Capacity:

| | | |
|-------|-------|---------|
| Model | 421RB | 30 gal. |
| | 423RD | 32 gal. |
| | 424RC | 40 gal. |
| | 427RC | 36 gal. |
| | 427RQ | 36 gal. |
| | 428RQ | 31 gal. |
| | 429WQ | 31 gal. |

WATER PUMP

Pressure for the water system is supplied by a water system demand pump which is fully automatic after initial priming. When a faucet is opened, the pump begins operation to provide a constant flow from the tank. When the faucet is closed, the pump automatically shuts off.

WATER PUMP SWITCH

The water pump switch is located on the water/holding tank monitor panel. (See Section 8). While the switch is in the "ON" position, the pump will automatically supply water pressure as it is needed. It is recommended that the pump switch be turned off whenever you are away from the vehicle or not using the water system. A slow leak in a faucet could drain the water system and discharge the coach battery.

INITIAL START-UP

1. Make sure that all water drain valves are closed, including water heater. (Refer to Section 11.)
2. Turn water pump switch to "OFF" position. Fill water tank.
3. Open all faucets, hot and cold.
4. Turn on pump switch.
5. Close each faucet as it begins to deliver a steady stream of water (close cold water first). Leave hot water faucets on until they also deliver a steady stream of water. This will ensure that the water heater is filled with water.
6. Check to be sure pump stops soon after all faucets have been closed.
7. Pump is now ready for automatic operation. Pump will start when a faucet is opened and stop when the faucet is closed.

INSTRUCTIONS FOR DISINFECTION OF FRESH WATER SYSTEMS ON RECREATION VEHICLES

(As approved by the U.S. Public Health Service)

To assure complete disinfection of your fresh water system, it is recommended that the following procedure be followed on a new system, one that has not been used for a period of time, or one that may have become contaminated. This procedure is also recommended before long periods of storage such as over winter.

1. Prepare a chlorine solution using 1 gallon of water and 1/4 cup of household bleach (sodium hypochlorite solution). With tank empty, pour chlorine solution into the tank. Use 1 gallon solution for each 15 gallons of tank capacity. This procedure will result in a residual chlorine concentration of 50 ppm in

the water system. If a 100 ppm concentration is required as discussed in item 3, use 1/2 cup of household bleach with 1 gallon of water to prepare the chlorine solution. One gallon of the solution should be used for each 15 gallons of tank capacity.

2. Complete filling of tank with fresh water. Open each faucet and run the water until a distinct odor of chlorine can be detected in the water discharged. Do not forget the hot water taps.
3. Allow the system to stand at least 4 hours when disinfecting with 50 ppm residual chlorine. If a shorter time period is desired, then a 100 ppm chlorine concentration should be permitted to stand in the system for at least 1 hour.
4. Drain and flush with fresh water.

WARNING

Chlorine is poisonous - recap bottle and clean utensils after use.

Never use automotive type antifreeze in your potable water system as it is poisonous.

EXTERNAL WATER SUPPLY ("City Water")

To operate from an external source

1. Turn the demand pump switch to OFF.
2. Attach a hose from the external water source to the city water connection on your vehicle. This connection is located on the left side of the vehicle, either on the sidewall or in a water system compartment.
3. Turn on the external water source.

City Water
Connection



When connected to an outside source of water, the water bypasses the demand pump and storage tank and supplies pressure directly to individual faucets and toilet. A check valve built into the pump prevents water from entering the pump and filling the storage tank.

To disconnect from the external source:

1. Turn the external source off.
2. Open a faucet inside the vehicle to relieve line pressure.
3. Disconnect the hose from the vehicle and replace the cap on the connection.

WATER DRAIN VALVES

The water drain valves are used to drain water from the water tank and the water supply lines when preparing the motor home for storage or when sanitizing the water system.

To open the valves, simply pull the rings upward approximately 1/2". To close, push the valve shafts downward until they are fully seated.

Drain valve locations are identified on page 7-5.

SHOWER VALVE PRESSURE BLEED-OFF

After using the shower, you may notice water dripping from either the shower head or the faucet assembly. The dripping results when vacuum in the shower hose (after closing the shower valve) slowly dissipates and allows water remaining in the hose to drain down. This is a normal water pressure bleed-off function of the shower valve assembly and is not a leak or defect.

The International Association of Plumbing and Mechanical Officials Standard TSC 21-85 (PAR. 4.3) states:

"Shower heads which incorporate shutoff valves, shall have a minimum "drip rate" of one (1) quart in thirty (30) minutes."

CAUTION

If items are placed into the shower tub before shower valve water pressure bleed-off is complete, they may become wet.

EXTERIOR SHOWER

The exterior auxiliary shower feature allows you to do things such as rinse off sand or salt after a swim, rinse off muddy boots, or bathe your pet outside the coach.

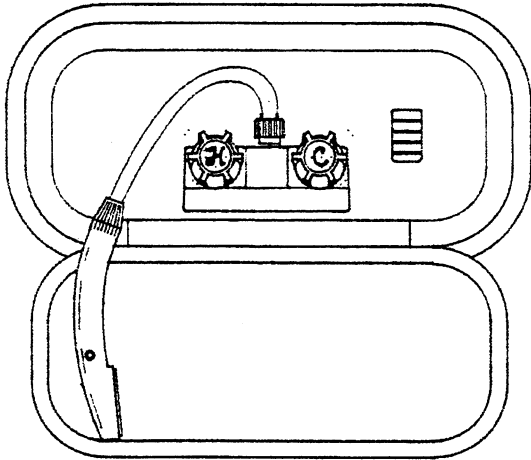

The exterior shower is not intended for use during freezing weather. If you wish to use your coach during freezing temperatures, disconnect the exterior shower from the coach water system as described below.

WINTERIZING THE SHOWER

1. Turn the water pump off and disconnect the city water supply if attached.
2. Open the water line floor drains. Pull the rings up about 1/2" to open. See page 7-5 for locations in your coach.
3. Open the exterior shower compartment and disconnect the shower hose from the faucet.
4. Open the hot and cold knobs on the shower faucet and allow it to drain. **DO NOT** close the knobs after draining.
5. Drain the shower hose, then reattach it to the shower faucet.
6. On the inside of the coach, close the shower water supply valves (if equipped) to disconnect the exterior shower from the water system. See page 7-5 for locations in your coach, if equipped.
7. Close the water line drain valves. The exterior shower is now winterized.

To use the shower again in warm weather, simply open the shower supply valves inside the coach.

See Section 11 - "Storing Your Motor Home" for directions on winterizing all coach systems.

WASTE DRAINAGE SYSTEM

The waste drainage system is self-contained, allowing use of the toilet, sinks, or shower even in areas where hook-up is not available. The drainage system may have two or three holding tanks depending on model and floor plan.

The holding tanks are dumped through a common outlet located on the left side of the vehicle, near the rear wheels.

DUMPING HOLDING TANKS

1. Remove drain hose from rear bumper or exterior storage compartment.
2. Remove dust cap from drain and connect drain hose. Be sure it is firmly attached.
3. Place the other end of sewer hose into disposal opening.
4. Open the (large) sewage valve with a quick pull. **OPEN ONE VALVE AT A TIME.** Move hose gently about to dislodge any waste and to ensure complete drainage.

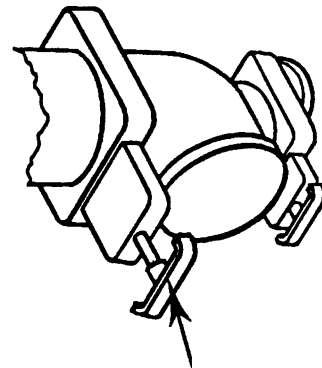

Pull to drain sewage

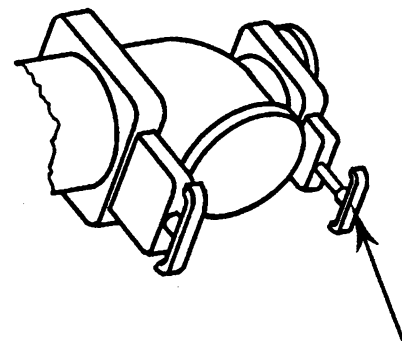

Pull to drain waste water

5. Close sewage valve and open (small) waste water valve with a quick pull. Make sure there are no sags in the hose during drainage. Close valve handle as soon as tank is empty.
6. After both tanks have been drained, run several gallons of water into the sewage tank through the toilet. Then open sewage dump valve and drain the tank again. Close valve and securely replace dust cap.
7. It is advisable to add an odor control chemical to the sewage holding tank. These chemicals are available at most R.V. stores.
8. Rinse sewer hose thoroughly with water and stow.

NOTE: We recommend that you dump all holding tanks before traveling to avoid carrying unnecessary weight.

USING ON-SITE SEWER HOOK-UPS

The drain hose may remain attached to the dump outlet while the motor home is parked and connected to an on-site sewage hook-up.

When using a sewer hook-up, keep the dump valves closed until a tank becomes full or when preparing to leave the site. This keeps the solids in suspension, allowing them to be carried out with the liquids when the dump valve is opened. If the valve is left open, the liquids will drain off, leaving solids in the tank. Should this accidentally happen, disconnect the hose, fill the tank about half full with water, and drive a few miles to dislodge the solids. A few starts and stops will aid in the process. Then reconnect the hose and drain in the normal manner.

HOLDING TANK LEVEL INDICATORS

You can check the levels of the waste water holding tanks and the fresh water tank using the monitor panel located on a wall near the rangetop.

Press the switch labeled "Levels Test" to show the levels in all tanks.

See Section 8 - Appliances for further information on the monitor panel.

Holding Tank Capacities:

| Model | Tank 1 (Toilet/Lav.) | Tank 2 (Galley/Shower) |
|-------|-------------------------|---------------------------|
| 421RB | 34 gal. | 31 gal. |
| 423RD | 25 gal. | 25 gal. |
| 424RC | 29 gal. | 36 gal. |
| 427RC | 32 gal. | 40 gal. |
| 427RQ | 30 gal. | 40 gal. |
| 428RQ | 29 gal. | 40 gal. |
| 429WQ | 29 gal. | 40 gal. |

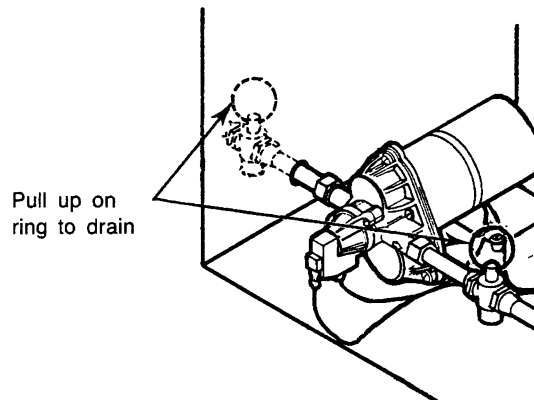

Water Drain Valves (Typical)

WATER SYSTEM DRAIN VALVE LOCATIONS

| MODEL | SYSTEM | DRAIN VALVE LOCATIONS |
|-------|---|--|
| 421RB | <p>Water Lines:</p> <p>Water Tank:</p> <p>Water Heater:</p> | <p>Two (2) valves beneath front dinette seat. Two (2) valves beneath bathroom lavatory cabinet.</p> <p>One (1) valve beneath couch.</p> <p>Drain plug on outside of coach, behind service door. Use socket to remove drain plug.</p> |
| 423RD | <p>Water Lines:</p> <p>Water Tank:</p> <p>Water Heater:</p> | <p>Two (2) valves on floor of galley cabinet. Two (2) valves on floor of bathroom lavatory cabinet. Two (2) valves beneath front dinette seat or couch. Two valves beneath rear couch or passenger side rear dinette seat.</p> <p>One (1) valve beneath rear couch or passenger side rear dinette seat.</p> <p>Drain plug on outside of coach, behind service door. Use socket to remove drain plug.</p> |
| 424RC | <p>Water Lines:</p> <p>Water Tank:</p> <p>Water Heater:</p> | <p>Two (2) valves behind access panel beneath shower tub. One (1) valve under rear dinette seat.</p> <p>One (1) valve beneath rear dinette seat.</p> <p>Drain plug on outside of coach, behind service door. Use socket to remove drain plug.</p> |
| 427RC | <p>Water Lines:</p> <p>Water Tank:</p> <p>Water Heater:</p> | <p>Two (2) valves on floor of galley cabinet. One (1) valve in passenger side rear cargo compartment. Two (2) valves on floor of bathroom lavatory cabinet (except when equipped with exterior shower option*).</p> <p>One (1) valve in passenger side rear cargo compartment.</p> <p>Drain plug on outside of coach, behind service door. Use socket to remove drain plug.</p> |
| 427RQ | <p>Water Lines:</p> <p>Water Tank:</p> <p>Water Heater:</p> | <p>Two (2) valves on floor of galley compartment. One (1) valve beneath rear bed - lift to access. Two (2) valves beneath shower tub - access below dinette seat (except when equipped with exterior shower option*).</p> <p>One (1) valve near water tank beneath rear double bed or driver side twin bed. Lift bed to access.</p> <p>Drain plug on outside of coach, behind service door. Use socket to remove drain plug.</p> |
| 428RQ | <p>Water Lines:</p> <p>Water Tank:</p> <p>Water Heater:</p> | <p>Two (2) valves on floor of galley compartment. Two (2) valves on floor of bathroom lavatory cabinet (except when equipped with exterior shower option*).</p> <p>One (1) valve near water tank beneath queen bed or driver side twin bed. Lift bed to access.</p> <p>Drain plug on outside of coach, behind service door. Use socket to remove drain plug.</p> |

WATER SYSTEM DRAIN VALVE LOCATIONS

| MODEL | SYSTEM | DRAIN VALVE LOCATIONS |
|--------------|---------------|--|
| 429WQ | Water Lines: | Two (2) valves beneath range. Remove bottom drawer to access. |
| | Water Tank: | Queen bed: One (1) valve beneath bathroom lavatory cabinet (behind access panel with finger hole). Twin beds: One (1) valve beneath right (passenger side) twin bed. |
| | Water Heater: | Drain plug on outside of coach, behind service door. Use socket to remove drain plug. |

SECTION 8

APPLIANCES

(See also Safety Precautions, Section 1 of this manual.)

IMPORTANT

Some items described in this section may be optional and may not be in your vehicle.

The appliances installed in your motor home are manufactured by reputable RV appliance makers and have been tested by independent laboratories to meet all applicable standards and codes set for RV appliances. These appliances are covered by your New Vehicle Limited Warranty. (Certain items may be covered by individual manufacturer's warranty.) See your New Vehicle Limited Warranty for details.

REFRIGERATOR

The refrigerator in your coach can be operated from either of two power sources available to the motor home:

- 110-Volt AC electric
- LP gas

The refrigerator is an absorption type which uses an ammonia-water solution for cooling. Basically, ammonia vapor is distilled from the solution by heat, produced from either LP gas or electricity and then carried to the finned condenser where it liquifies. The liquid flows to an evaporator where it creates cold temperatures through evaporation.

LEVELING

Before operating the refrigerator when the motor home is stationary, place a small level on the freezer shelf and make certain the unit is level.

CAUTION

To obtain proper performance from the refrigerator and prevent damage to the cooling unit, make certain the motor home is level side to side and front to rear when parked. If the motor home is parked in an out-of-level position for more than one hour, the refrigerator must be turned off.

Normal vehicle leveling to provide comfort for the occupants is satisfactory for refrigerator operation. This will be well within the operation

limits of 3° off-level side to side and 6° off-level front to back.

OPERATING INSTRUCTIONS

Norcold 6000 Series

Start Up Instructions - Auto Mode

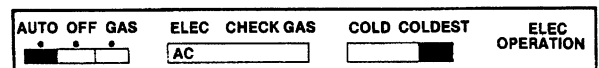

1. Move thermostat to COLDEST position. Set AUTO-OFF-GAS switch to AUTO.
2. If 110 volts is active, the panel will display AC, indicating refrigerator is operating in 110 volt AC mode.
3. If 110 volts AC is inactive (power failure, disconnected, etc.), it will display LP, indicating refrigerator has automatically switched to LP gas mode.
4. If the panel displays LP and a red X continuously, the refrigerator has failed to ignite burner on gas mode. Restart gas operation by moving AUTO-OFF-GAS switch to OFF and back to AUTO. (See steps 3, 4, and 5 under Gas Mode). NOTE: Unit operation will automatically return to AC when 110 volts AC is restored, even if the unit is locked out on gas operation.
5. Move thermostat to desired setting, usually a middle setting.

Start-Up Instructions - Gas Mode

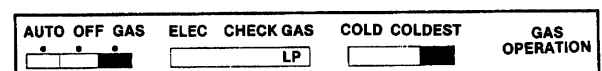

1. Move thermostat to COLDEST position, Set AUTO-OFF-GAS switch to GAS.
2. The panel will display LP, indicating LP gas mode. (If LP is not displayed, check for loss of DC supply voltage.) Initially, the red X will be displayed for about 5 seconds; after which, sparking will start at the burner and the red X goes off.
3. After 10 seconds, the burner should ignite and operate normally.

4. On the initial refrigerator start-up, it may take longer than 10 seconds to allow air to be purged from the gas line. If gas does not ignite within 10 seconds, valve will automatically shut off and the red X will be displayed at the CHECK position.
5. To restart when the X is displayed, move AUTO-OFF-GAS switch to OFF position, then return switch to the GAS position.
DO NOT CONTINUE TO RESET GAS SWITCH IF THE CHECK INDICATION CONTINUES TO DISPLAY AFTER SEVERAL TRIES.

Shut Down Instructions - Gas or Electric

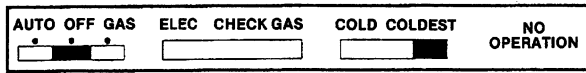

Short Duration: Set AUTO-OFF-GAS switch to OFF.
Long Duration: Set NORMAL-STORAGE-HIGH HUMIDITY switch (located on divider between the two doors) to STORAGE.

LOCATION OF CONTROLS

The Mode Selector is located above the upper door and includes the thermostat for controlling the interior temperatures, the switches which select the operating mode, and the panel which continuously displays the selected operating mode. On the divider panel, located between the two doors, is the High Humidity and Storage switch. (See following paragraphs for a description.) The light switch is located in this area to automatically activate the cabinet light when the lower door opens.

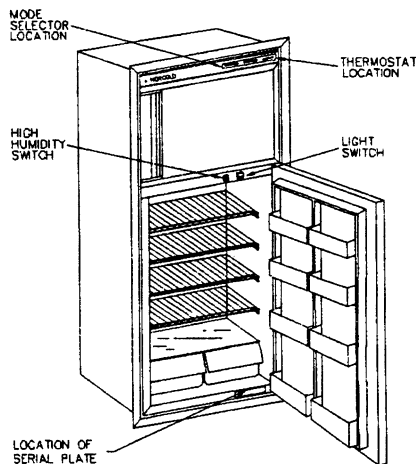

Mode Selector

AUTO:

The refrigerator will operate on 120 volts AC so long as AC power is available to the refrigerator. If AC power is lost (or disconnected), the Selector will automatically switch to gas operation. As soon as AC power is restored, the Selector automatically switches back to AC operation. (The user does not have to manually switch the refrigerator back to AC.) When the operation is automatically switched to gas, the burner will ignite and continue to operate the refrigerator at the same thermostat setting as set for AC power. The gas operation assumes that an LP gas and 12-volt DC supplies are available.

GAS:

This selection allows the refrigerator to operate on LP gas only. It will not automatically switch modes regardless of whether AC power is connected or not. If the flame is lost (LP tank empty, etc.), the operation locks out and must be manually reset.

Quick Reference

For Gas Operation:

- Propane gas must be available
- 12 Volts DC
- NOTE: 12 volts is necessary to automatically light or relight gas burner.
- Controls set per "Lighting Instructions"

For AC Operation:

- 110 Volts AC (108 volts minimum)
- Controls set per "Start-up Instructions"

HUMIDITY - STORAGE SWITCH

Turning this switch to HIGH HUMIDITY will keep the surface between the door openings dry during high humidity conditions. The switch should be left in the NORMAL OPERATION position unless moisture collects around the door.

When storing your RV for the winter, place this switch in the STORAGE (LIGHT OFF) position. This shuts off all DC power to the light and humidity heater and allows the refrigerator door to be left open for airing without draining the battery.

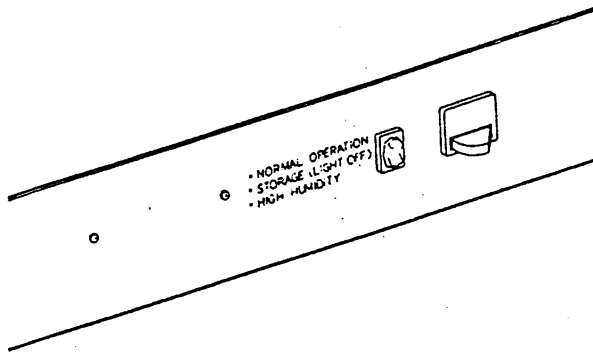

Further Information

For further information and operating cautions, see the Norcold refrigerator operating instructions included either inside the refrigerator or in your Motor Home Operations Manual binder.

REFRIGERATOR COMPARTMENT (Exterior)

The exterior refrigerator compartment allows access to the rear of the refrigerator for inspection, maintenance or service.

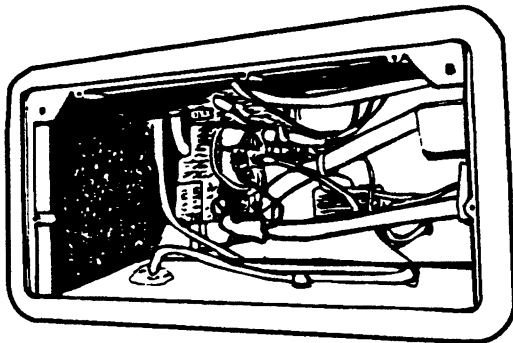

Refrigerator Access Compartment

To Open:

1. Use a coin to turn the latch knobs to the left 1/4 turn to the vertical position as shown.
2. Remove the door from the opening.

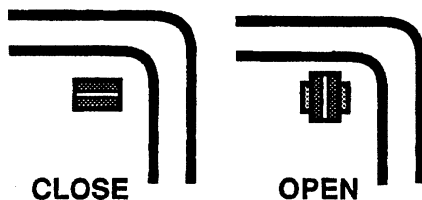

Refrigerator Access Door Latches

To Close:

1. Replace the door into the opening.
2. Push the latch knobs in while turning to the right 1/4 turn to the horizontal position as shown.

RANGE AND OVEN

The range and oven in your motor home are operated on LP gas and will provide nearly all of the functions that the range in your home does. One of the features of gas burners is that heat is available as soon as a burner is lit, as opposed to an electric element heating up. The range has a "Pilot Off" position on the oven control which allows the oven pilot to be turned off when traveling or refilling the LP tank.

The following warning label has been located in the cooking area to remind you to provide an adequate supply of fresh air for combustion.

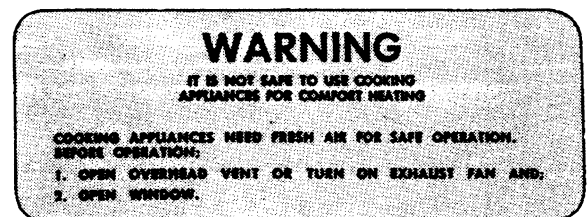

Unlike large homes, the oxygen supply inside a recreational vehicle is limited due to its size. To avoid danger of asphyxiation, provide proper ventilation when using the gas rangetop or gas oven. It is especially important not to use the gas oven and rangetop for comfort heating. Danger of asphyxiation is greater when these appliances are used for long periods of time.

WARNING

Portable fuel-burning equipment, including wood and charcoal grills and stoves, shall not be used inside the recreational vehicle. The use of this equipment inside the recreational vehicle may cause fires or asphyxiation.

Use of Top Burners

1. Light match.
2. Apply lighted match to burner.
3. Turn control knob left (counterclockwise) to the "LITE" position.
4. When the burner lights, adjust the flame height by turning the knob toward the "OFF" position.

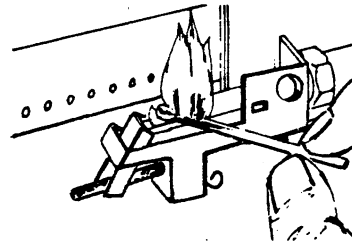
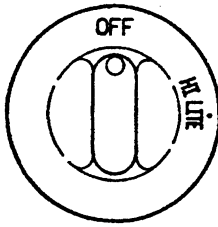

Lighting oven pilot (when pilot is located on the right side of burner.)

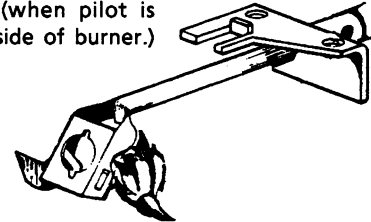

Lighting oven pilot (when pilot is located on left side of burner.)

WARNING

Do not turn burner control knob to on and allow gas to escape before lighting match.

LIGHTING OVEN PILOT

NOTE: If range has not been operated for a long period of time, a longer waiting period for ignition of the pilot may be necessary due to air in the gas line.

1. Be sure all valves are in the "OFF" Position. The oven control knob should be in "OFF" position.
2. Turn on main gas supply to range.
3. Depress and turn control knob to the "PILOT ON" position. This will allow gas to oven pilot.
4. Open oven door and light oven pilot with a match. Small flame will be noted at the top of the pilot burner.

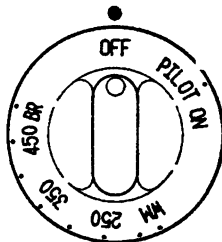

Oven Control Knob in "OFF" position

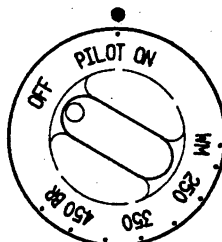

Oven Control Knob in "PILOT ON" position.

OPERATING THE OVEN CONTROL

Depress and turn the oven control knob (counterclockwise) to the desired temperature setting.

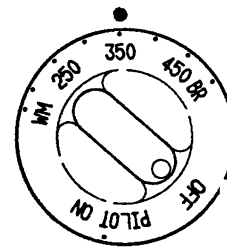

There is a delay of about 45 seconds before the main burner ignites. This is normal and there is no gas escaping during this delay. It is also normal for the oven burner flame to cycle off and on at all set temperatures except broil.

SHUT DOWN INSTRUCTIONS

When oven cooking is finished, turn the oven control knob to the "PILOT ON" position, the oven standby pilot will remain lit.

When the recreational vehicle is not in use or while traveling, turn the oven control knob to "OFF" position and turn off main gas supply; this will turn off the oven pilot.

MICROWAVE OVEN (Optional)

For complete operating instructions, refer to the manufacturer's information provided with the oven.

RANGE HOOD

The range hood vent allows you to exhaust cooking odors and gas fumes to the outside of the coach and to supplement fresh air ventilation. A light on the underside of the hood provides illumination for food preparation.

The auxiliary electric generator start/stop switch and hourmeter are also located on the range hood panel. See section 6 for generator starting and stopping instructions and operating precautions.

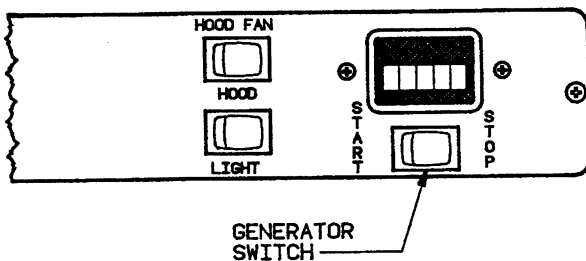

HOOD FAN AND LIGHT SWITCHES

To turn on the range hood light, simply push the switch labeled "Hood Light". To operate the range hood fan, push the "Hood Fan" switch toward "High" or "Low" depending on the volume of exhaust desired.

WATER HEATER SWITCH

Be sure the water heater is filled with water before pressing this switch. To fill the water heater, turn the water pump switch on and open a hot water faucet until water begins to flow.

On electronic ignition models, the "W.H. Out" light will glow for about 10-15 seconds after the water heater switch is turned on, then it will go off. If the light comes on during normal operation, it means that the burner has gone into "lockout" mode. Turn the switch off for about 5 minutes, then turn back on. See "Water Heater" elsewhere in this section for further information.

MONITOR PANEL (Wall Mounted)

At the push of a single button this monitor panel simultaneously displays the coach battery condition and levels of the water tank, holding tanks and LP tank. It also contains the water pump power switch and an indicator light to show when the pump switch is on.

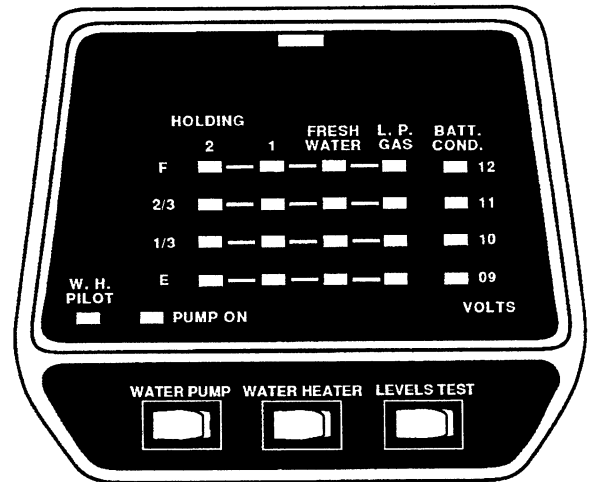

Monitor Panel

WATER AND HOLDING TANK LEVELS

Press and hold the "Levels Test" switch to show approximate level on the monitor lights.

Approximate levels of the fresh water and holding tanks are measured by sets of electronic probes in the sides of the tanks. The liquid must be at or above a probe to illuminate the indicator lights to a given level.

For example, a water level of 1-2" above the 1/3 probe would register as only 1/3 full. Consequently, a level of merely 1" below the 1/3 probe would register empty. Generally speaking, there is actually more liquid in a tank than indicated.

LP GAS LEVEL

Press and hold the "Levels Test" switch to show approximate LP tank level.

The LP level is registered by a sending unit on the tank. The gauge mounted on the side of the tank will give a more accurate indication of actual tank level if needed.

WATER PUMP SWITCH

When use of the self-contained water system is desired, turn the "Water Pump" switch on. Water will be available as soon as a faucet is opened. Refer to "Fresh Water System" for additional information on the water pump and initial start-up.

BATTERY CONDITION METER

Push the "Levels Test" button to check the level of charge (voltage) in the 12-volt coach battery. The colored segments (red, yellow and green) will light from the bottom up to the amount of charge the battery contains.

- Green - good or adequate charge.
- Yellow - marginal charge.
- Red - battery needs charging before use.

Water Heater Switch and "W.H. Pilot" Indicator

Be sure the water heater is filled with water before pressing this switch. To fill the water heater, turn the water pump switch on and open a hot water faucet until water begins to flow.

The "W.H. Pilot" light will glow for about 10-15 seconds after the water heater switch is turned on, then it will go off.

If the "W.H. Pilot" light comes on during normal operation, it means that the burner has gone into "lockout" mode. Turn the switch off for about 5 minutes, then turn back on.

WATER HEATER

Direct Ignition Models G6A-6E, GH6-6E, and GCH6-6E (Optional)

1. Place Water Heater switch in the "On" position.
2. If "W.H. Pilot" light stays on longer than 15 seconds, place switch in "Off" position and wait 5 minutes.
3. Repeat step one.
4. For a complete shut-down and before servicing:
 - a. Place Water Heater switch in "Off" position.
 - b. Remove red wire from left-hand terminal of ECO switch (ECO to valve).
5. If heater fails to operate due to high water temperature, the heater will go into a lockout condition ("W.H. Pilot" light on). When water cools, reset by placing switch in "Off" position for at least 30 seconds, then return to "On" position.
6. If a lockout condition persists: contact your dealer, an Atwood Service Station or Atwood Service Department (Phone: 815-877-7461).

WATER HEATER

Pilot Models G6A-6, GH6-6, G4-6, GC6A-6, and G6A-6P (Standard)

CAUTION

Do not tamper with the pilot orifice. High water temperature can result.

1. Turn lighting control to "Off" position.
2. Wait at least five minutes to allow gas which may have accumulated in burner compartment to escape.

3. Note that your water heater may have either a Robertshaw "Unitrol" or "Jade" control.

For a Robertshaw "Unitrol":

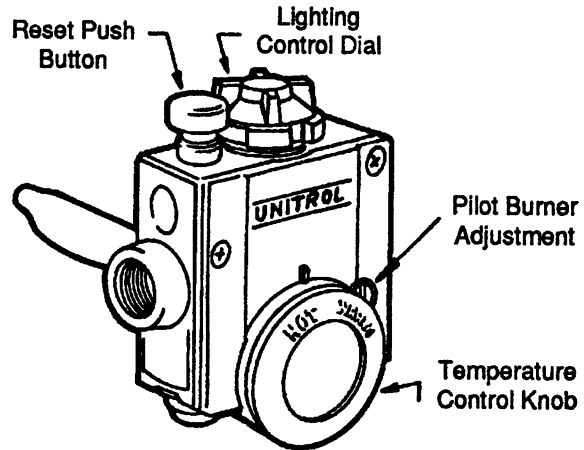

- a. Turn lighting control dial to "Pilot" position.
- b. Depress and hold reset push button while lighting pilot burner.
- c. Allow pilot to burn for one-half minute before releasing button.
- d. Turn control dial to "On" position.
- e. If pilot does not remain lit, repeat operation, allowing longer period before releasing push button.
- f. Set the dial at the mid-point position between warm and hot.
- g. Close access door.

For "Jade" Control:

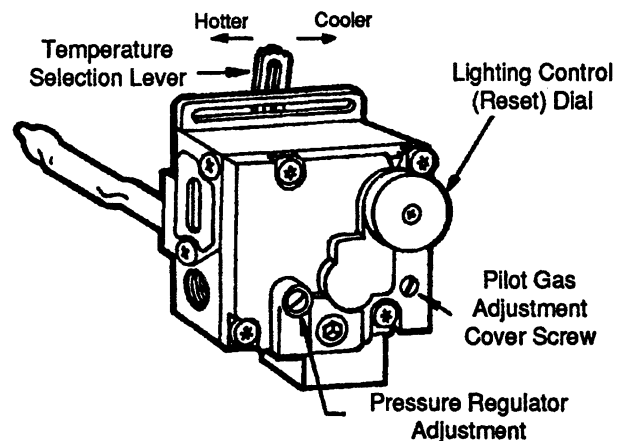

- a. Turn lighting control dial to "Pilot" position and hold against stop while lighting pilot burner.

- b. Allow pilot to burn approximately one-half minute before releasing dial.
 - c. Turn control knob to "On" position.
 - d. If pilot does not remain lit, repeat operation, allowing longer period before releasing button or knob.
 - e. Set the lever at the mark between the warm and hot position.
 - f. Close access door.
4. For complete shut-down and before servicing, turn lighting dial to "Off" position.

CAUTION

The temperature knob or lever is factory adjusted to its lowest setting. We recommend the mid-point position between warm and hot, as noted above. This will provide for energy efficient operation and sufficiently hot water. Setting at a higher position will produce a higher temperature and increase the risk of being scalded.

WATER HEATER

PRESSURE-TEMPERATURE RELIEF VALVE

On occasion, water may be seen seeping from the water heater pressure temperature relief valve. This is no cause for repair or replacement of the valve.

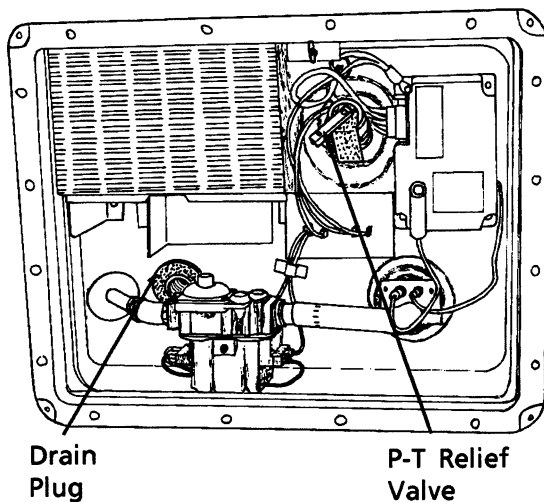

Water Heater Exterior Access

Normally, there is an air gap at the top of the water heater tank which acts as a pressure buffer. In time, however, expanding water may absorb this air gap, causing a slight increase in pressure. This may cause the P-T valve to "weep" until the air gap is replaced manually.

To Replace the Air Gap:

1. Turn off the water heater switch and incoming water supply (city water and/or demand pump).
2. Open a faucet in the motor home.
3. Pull the handle of the P-T valve straight out and allow water to flow until it stops.

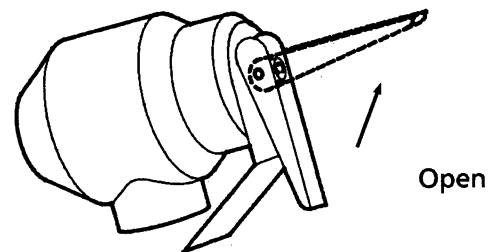

4. Let the handle of the P-T valve snap shut.
5. Close the faucet and turn on the water supply before switching the water heater on.

Manually operate the pressure thermostat relief switch at least once a year. OPERATE THIS VALVE ONLY WHEN THE WATER HEATER AND COOLING SYSTEM ARE COLD!

WATER HEATER CAPACITY: 6 gal.

MOTOR AID (Optional)

The motor aid acts as a heat exchanger between the water heater and the vehicle engine. Two hoses from the water heater connect to the hoses which deliver hot water between the engine and the driver's compartment heater. A heat exchanger in the water heater then circulates the water from the engine radiator around the water heater tank. Under normal conditions, the entire contents of the water heater tank will be heated to approximately 140°F in about two hours or 100 miles of driving.

In addition, the motor aid heat exchanger helps the vehicle engine to operate at cooler temperatures by dissipating heat from the engine. This reduces the possibility of overheating, particularly when operating in hot climates.

CAUTION

Any leak in the heat exchanger or its supply or return lines could cause loss of coolant and subsequent engine failure. We recommend that the user make frequent inspection of these connecting lines and the heater to insure that no leaks have developed.

MOTOR AID WATER HEATER AND REAR AUXILIARY HEATER MAINTENANCE

Have your authorized dealer check all hose clamp connections on the rear automotive heater and the motor aid water heater at least every six months and tighten them if necessary.

LP GAS FURNACE (SUBURBAN)

Operating Instructions

1. Close the LP gas tank valve.
2. Turn thermostat switch ON.

Temperature Selector

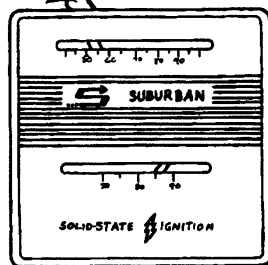

Thermostat Switch

3. Set thermostat above room temperature to begin blower operation. A slight delay will occur before the blower comes on. Allow blower to run for 5 minutes for combustion chamber purge cycle.
4. After 5 minutes, move thermostat lever below room temperature. Blower will remain on. Wait approximately 2 minutes for blower to go off.
5. Open LP gas tank valve.
6. Set thermostat to desired temperature. If set above room temperature, blower will come on.
7. Allow 30 seconds for main burner to light after blower comes on. This furnace is equipped with an ignition device which

automatically lights the burner. Do not try to light the burner by hand.

8. If burner does not light, repeat Steps 1 through 5.
9. If after three (3) attempts with no ignition, go to shut-down and contact your dealer or a local recreational vehicle service agency. Do not continue to cycle furnace through thermostat in an attempt to get ignition.

To Shut Down:

1. Move thermostat switch to "OFF" position.
2. Close LP gas tank valve.

ROOF AIR CONDITIONERS

Refer to the manufacturer's information in your Motor Home Operations Manual binder for complete operating instructions.

TV ANTENNA - Optional

The TV antenna on your motor home can be easily raised, rotated a full 360° and lowered from inside the vehicle by simply turning a crank or rotating disc. A built-in signal amplifier designed to strengthen signals is controlled by a power switch built into the TV jack assembly.

The signals amplifier is housed inside the antenna with the circuit board connected directly to the antenna elements. Power to operate the amplifier (12-volt DC) is supplied through the downlead cable which also carries the TV signals to the TV set. The power supply separates the 12-volt DC from the TV signals and provides a place to attach the TV set and the 12-volt power source.

Operation

Raising Antenna - Turn elevating crank clockwise in "UP" direction about 13 turns or until some resistance to turning is noted. Antenna is now in operating position. Check to assure power supply switch is "ON"

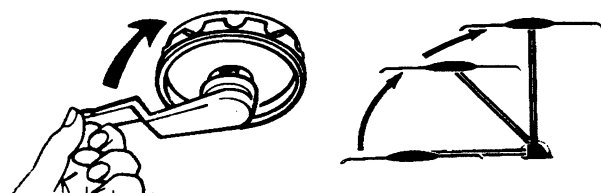

WARNING

Never allow the antenna to touch electrical power lines or any other electrical wires.

Rotating Antenna - Make sure antenna is in the "UP" position. Pull down on rotating knob until it disengages ceiling plate and rotate for best picture and sound on TV set.



Lowering Antenna to Travel Position - Rotate antenna until pointer on rotating knob aligns with pointer on ceiling plate.

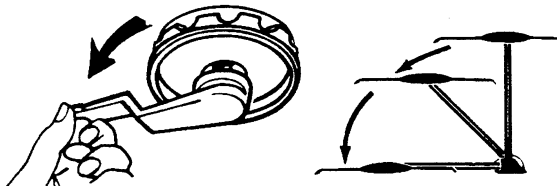

CAUTION

Never leave the antenna partially raised or partially lowered. This can damage the crank mechanism gears. Always raise the antenna straight up or lower it completely into the travel position.

Turn elevating crank (counterclockwise) in "DOWN" direction until resistance is noted. Antenna is now locked in travel position. Return power supply switch "OFF".

Count number of turns needed to crank the antenna down to the roof of the unit (normally about 13). Mark the final position of the crank handle on the ceiling or the directional knob for reference. Also mark the number of turns needed. Use the mark and number as a reference whenever you lower the antenna.

CAUTION

Always align directional handle to "DOWN" position before lowering.

SIGNAL AMPLIFIER

To operate amplifier, turn on power switch.

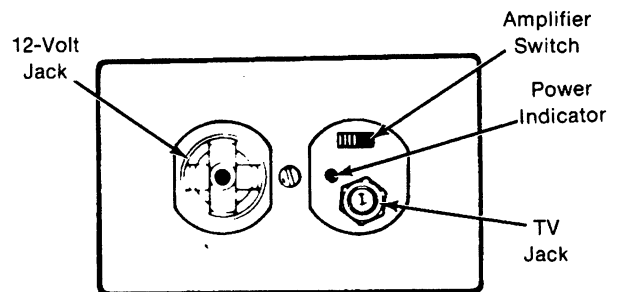

12-VOLT AND TV JACKS

The TV jack plate is mounted beneath the passenger side front overhead cabinet.

CHECKING RECEPTION

The TV signals available to an RV are entirely dependent on its location in relation to the transmitter. Signals may vary from strong to no usable signal at all. We recommend that you check the TV system in an area known to have good TV reception.

To check the antenna amplifier, raise the antenna, select a TV channel and rotate the antenna for best picture. Then turn off the amplifier power switch. If the antenna amplifier is working properly, the TV picture will now be degraded (snowy). When you turn the switch back on, the picture should again be sharp.

CABLE TV HOOK-UP

Some models are equipped with external connections for cable television. The connector is located in the shoreline cord compartment.

NOTE: Be sure the TV antenna amplifier switch is turned OFF while connected to cable. The antenna amplifier will make the cable TV signal snowy.

**EXTERIOR ENTERTAINMENT CENTER -
Optional**

The exterior entertainment center contains a stereo radio/cassette player and convenient TV hook-ups for your outside listening or viewing pleasure.

This feature also includes a TV table. The table is typically stored in the wardrobe or beneath one of the dinette seats. Unfold the table-to-sidewall braces and hook the table bracket over the bottom lip of the compartment door (like a drive-in restaurant car window tray).

Do not use a TV larger than 14" on the table. A larger TV could damage the table, compartment door or sidewall.

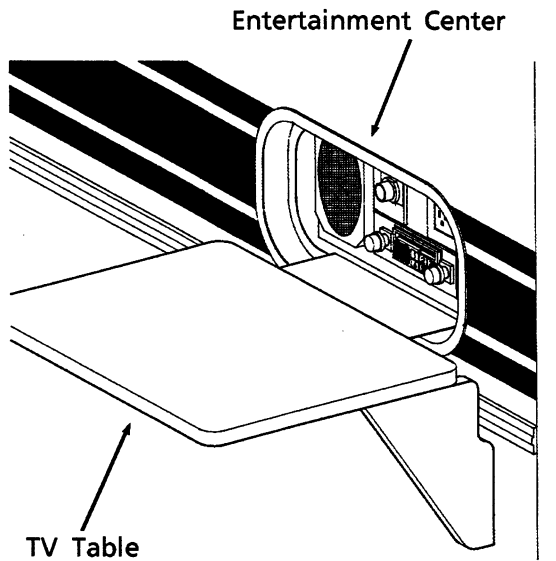

SECTION 9

INTERIOR FEATURES AND FURNISHINGS

(See also Safety Precautions, Section 1 of this manual.)

IMPORTANT

Some items described may be optional or unavailable on your vehicle.

SLEEPING FACILITIES

WARNING

Do not use sleeping facilities while vehicle is moving.

OVERHEAD BUNK

The overhead bunk is located above the driver's compartment. While in the stored position, it allows easy access to the front seats from the living area of the motor home. It conveniently and easily converts to a full-size bed as described below.

1. To convert to a bed, grasp the loop on the top section of the mattress and carefully unfold to cover the driver's compartment.
2. To stow the bed while not in use, fold the rear mattress section forward onto the front section.

COUCH/BED CONVERSIONS

Continental Bed

To Convert Couch to Bed:

1. Remove the backrest cushions from the couch.
2. Grasp the front edge of the couch and pull upward and outward from the wall at the same time.
3. Lift the front edge of the seat cushion and unfold it toward the wall until it lies flat, forming a sleeping surface.

To Revert to Couch:

1. Fold the mattress forward from the wall to return the seat cushions upright.
2. Pull the front of the couch upward and push in toward the wall at the same time until fully seated against the wall.
3. Place the backrest cushions in their original locations.

Presto Bed/Shrock Bed

To Convert Couch to Bed:

Pull the front edge of the couch seat upward and outward from the wall while gently pushing downward on the backrest until the cushions lie flat. The bed is now ready for use.

To Revert to Couch:

Push the front edge of the seat toward the wall while lifting upward on the backrest until the couch is fully seated against the wall.

DINETTE/BED CONVERSION

To Convert Dinette to Bed:

1. Release the catch on the table leg brace and fold the leg up against the bottom of the table.

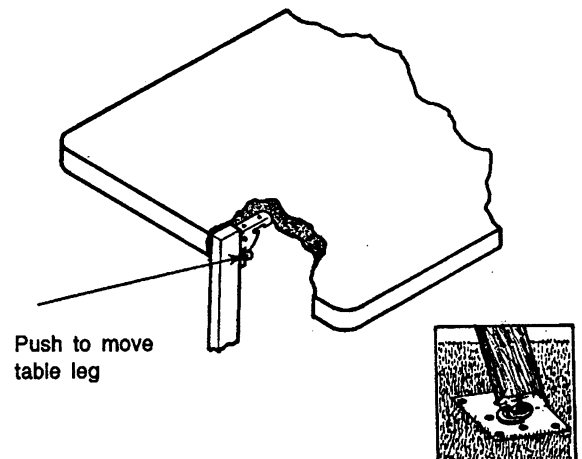

2. Remove the table from the wall support bracket by lifting the end of the table. Then lower the table to rest on the cleats attached to each dinette bench.
3. Arrange dinette cushions to cover bed area.

To Revert to Dinette:

1. Replace table onto the wall support and lower the table leg.
2. Make sure that the table leg is secured into the floor support bracket and the leg brace is locked.

FRESH WATER TOILET

The fresh water toilet in your motor home is very similar to the household type, except that it is designed to use only a small amount of water per flush. It uses a high velocity jet of water,

producing a swirl effect, to efficiently cleanse the bowl. And since each flush uses fresh water, no special chemicals are required other than a deodorizing agent, if necessary.

FLUSHING THE TOILET

1. To add water to the bowl before using, move the white lever to the right. Hold lever until desired level of water is reached. Release lever slowly - do not allow it to snap back. Generally, more water is required only when flushing solids.

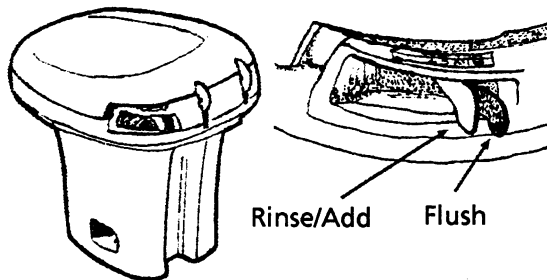

2. To flush the toilet, move the black lever to the right. (The black lever also moves the white lever.) Hold lever until bowl is clean.
3. Release lever slowly. A small amount of water should remain in the bowl.

Please refer to the manufacturer's information supplied with the toilet for further operating and maintenance instructions.

Important "Don'ts"

- Don't use facial tissue or regular toilet tissue in the RV toilet. These will not disintegrate sufficiently and will often cling to the sides of the holding tank. Toilet tissue made specifically for use in RV toilets and holding tanks is available at most RV supply centers.
- Don't dispose of sanitary napkins or other non-dissolving items in the toilet.
- Don't put automotive antifreeze or caustic chemicals, such as laundry bleach or heavy detergents into the toilet or holding tank. These products may damage plastic or rubber parts in the system.

CLEANING THE TOILET

The toilet should be cleaned regularly for maximum sanitation and operating efficiency. If an odor is apparent from the toilet:

1. Clean the toilet bowl with a mild bathroom cleaner. Do not allow cleaners to set in the bowl for long periods of time to avoid

damaging the seals. Do not use caustic or abrasive cleaners in the Thetford toilet since it may damage the plastic surfaces.

2. Dump and rinse holding tank.
3. Add odor control chemical in amount specified after cleaning and every few days during use.
4. Remove the water line from the base of the toilet and clean the screen.
5. If the flush valve becomes stiff after extended use, it may be lubricated with a silicone spray. Turn the water pump off and operate flush pedal/lever to drain water from the toilet bowl. Spray silicone lubricant onto flush valve inside bowl and operate flush pedal/lever a few times to ensure free operation.

See instructions in Section 11 to prepare the toilet for storage in freezing conditions.

POWER ROOF VENT - Bath Area

Some models are equipped with a powered roof vent in the bath area. A push-button switch for the vent fan is located up on the vent. The vent dome can be raised and lowered using the crank handle.

SLIDER WINDOWS

Lift the latch handle straight out from the window. Grasp the sliding window edge frame and slide the window to the side. Be sure the latch is raised before trying to slide the window closed.

QUARTZ WALL CLOCK TO REPLACE BATTERY

The clock is mounted in a socket on the face of the cabinet and is held in place with bristle pad material.

Carefully remove the clock from the socket by alternately prying the left and right sides gently outward.

After replacing the battery, simply press the clock firmly back into the socket.

COFFEE MAKER - Optional

The manufacturer's instructions for use and care are included in your operations manual binder.

To Remove for cleaning:

- Unplug the coffee maker from the electrical receptacle and remove the carafe (pot) from the burner plate.
- Pull the coffee maker unit firmly outward until it unlatches from the detents (snap notches) in the slide mount.

To Replace after cleaning:

- Angle the coffee maker unit upward slightly to start it into the slide mount.
- Push the unit straight back all the way into the slide mount.
- Press the sides of the slide bracket until you hear and feel them "click" into place.
- Plug the coffee maker unit back into the electrical receptacle.

SECTION 10

CARE & MAINTENANCE

CAUTION

Sealants must be inspected every 6 months and resealed if necessary.

ROOF

The roof utilizes Thermo-Panel® construction like the walls and floor. It will support the weight of an average adult should it become necessary to repair the roof or roof mounted components. It is not recommended, however, that very large or heavy objects be carried on the roof while the vehicle is in motion. (See page 4-1 for roof loading specifications) Always have damage to the roof area repaired immediately. Damaged or detached sealant around the vents, air conditioner, body-to-roof seams, etc., should also receive immediate attention. Delaying these repairs may allow water leakage and result in damage to interior ceiling and body panels, upholstery, etc.

UNDERBODY

Buildup of mud and dirt under the body can cause damaging rust on steel parts and can add needless weight to the vehicle. This, in effect, reduces the amount of cargo you can carry and remain within GVWR and GAWR limits.

Corrosive materials, such as those used for ice and snow removal and dust control, also accumulate on the underside of a vehicle. These materials should be removed by flushing the underbody regularly with water, especially areas where mud and other foreign materials collect.

EXTERIOR

The exterior surface of your motor home has an automotive finish. Frequent washing and thorough cleaning is recommended to prevent damage to the vehicle finish after exposure to damaging salts, calcium chloride, road tar, tree sap, insects and other foreign material. Never wash the vehicle in direct sunlight, while the vehicle surface is hot, or using hot water.

Do not use strong soaps or detergents for washing the motor home. Always use a mild soap in warm water, a commercially prepared product for cleaning automotive finishes or your local car wash. Be careful when using pressure-type

washers to avoid loosening exterior decals or sealants, etc.

After washing the motor home, carefully inspect caulking around window frames and vents and any other joints that may have separated. Recaulking, if necessary, is quite simple. Appropriate compounds are sold at Winnebago or Itasca dealers, and the materials are quickly and easily applied. Also, inspect weather seals around door, etc., and if necessary have a dealer replace them immediately.

CAUTION

Never use a strong solvent such as lacquer thinner, or harsh abrasives on painted surfaces.

It is recommended that a coat of automotive wax be applied to the surface occasionally to provide added protection against harmful deposits coming in contact with the paint.

CARE OF STRIPES AND DECALS

The pressure-sensitive decals on your coach require very little maintenance. They should be treated like any painted surface on your vehicle. Here are a few helpful hints on caring for decals:

- Wash decals with plain soap and water or any retail car wash soap. Always rinse thoroughly.
- Keep high-pressure wash nozzles at least 1 1/2 feet from edge of decals. High pressure water spray may cause edge lifting of decals.
- Test any cleaning solution on a small section of decal before using.
- Do Not use any aromatic solvents such as acetone, MEK, toluene, xylene, etc., on decals. Any solvent including alcohol may soften or smear colors.
- Do Not use lacquer thinner or paint on decals. Do Not overcoat decals with clear paint.
- Do Not let gasoline or other fuels drip and stay on decals for any length of time. Rinse immediately with water.

UPHOLSTERY, CARPETING AND DRAPERIES

We recommend a weekly routine of vacuuming all fabrics and carpet throughout the motor home to prevent an accumulation of dirt which can detract from the appearance and shorten the life of carpet and fabrics.

CARPET AND CLEANING

See the carpet manufacturer's Carpet Care Guide in your Motor Home Operations Manual binder. It includes detailed information on cleaning soils and removing stains from the fine carpet in your coach.

Upholstery

Some fabrics used in this motor home may contain fire retardant and lightfastness additives which can be damaged by use of improper cleaning products. Some water-based household cleaning products are not formulated for use on fabrics and may cause excessive shrinkage or fading. Always test any cleaning product on a hidden area of fabric before using on visible areas. For best results, fabric cleaning should be referred to a professional carpet and upholstery cleaner.

IMPORTANT

To minimize fading of upholstery, carpets and other interior fabrics caused by excessive sunlight, the drapes, blinds or shades should be closed when the motor home is parked for an extended period of time.

WARNING

When cleaning upholstery and fabric, do not use lacquer thinner, nail polish remover, laundry soaps, or bleach. Never use carbon tetrachloride, gasoline, or naphtha for any cleaning purpose. These materials may cause damage to the material being cleaned and most are highly flammable.

SPOTS AND STAINS

Spots or stains should be treated as soon as possible before they "set in" to avoid permanent damage. Always start from the outside of a spot or stain and work inward to avoid spreading it. Use a clean cloth or sponge and turn frequently to an unused area of the cloth or sponge as you clean.

Some stains or soils, such as lipstick, ink, grease or mustard, are extremely difficult or impossible to remove completely and should receive immediate attention. Consult a professional carpet and upholstery cleaner for assistance.

VINYL FABRICS

Vinyl should be cleaned with a soft, damp cloth and a mild detergent only. Do not use solvents. Solvents may damage the surface of the vinyl.

DRAPERIES, CURTAINS AND BEDSPREADS

These items may be woven from a variety of fabrics. We recommend that these be professionally dry cleaned only. A five percent shrinkage may occur when you have these items dry cleaned.

CABINETRY

Wooden items may be cleaned with a soft cloth and a good quality wood finish cleaning product such as Pledge™, Liquid Gold™, etc.

Vinyl simulated wood (Plus-Wood®) panels may be cleaned with a mild, water based cleaner and a soft cloth. Do not use solvents on vinyl wood panels.

NOTE: Many cabinetry and furniture items throughout this motor home are constructed either partially or completely of real hardwoods. Because of natural variations in woodgrain density, slight differences in stain hue may exist between one item and another. This is the distinctive character and beauty of real wood.

VINYL WALLBOARD

Decorative vinyl covered wallboards may be cleaned with a mild solution of water and isopropyl (rubbing) alcohol or a mild soap solution. Do not use solvents or abrasive cleaning products.

TABLES AND COUNTERTOPS

Work surfaces are covered with a plastic laminate that resists solvents, stains and abrasions. A coat of furniture wax applied to these surfaces on the counters and table will help preserve their beauty and make cleaning easier. Always clean the surface before applying wax.

STAINLESS STEEL SINK

The stainless steel sink can be cleaned with soap or detergent. Rinse thoroughly with warm water and wipe dry to avoid streaks.

Use a mild abrasive for stubborn stains. Work in the direction of the polish lines. To keep the original finish, polish with a wax cleaner and rub with a dry soft cloth.

WARNING

Salt, mustard and mayonnaise may cause pitting. If spilled, clean immediately.

RANGE AND REFRIGERATOR

For care and appearance maintenance of the range and refrigerator, refer to the operation and maintenance manual for each of the individual appliances included in your Motor Home Operation Manual binder.

BATHROOM

The shower walls in the bathroom should be cleaned with a mild soap and water solution, or (to obtain maximum luster) use a good quality wax cleaner. Do not use an abrasive cleaner on the shower walls. However, a mild abrasive cleaner may be used to clean the shower floor or bathtub. If the shower has a Plexiglass door, it is extremely important that abrasives not be used. Solvents and aromatic spirits that contain a petroleum base or additive should also not be used. These products can cause a reaction with the glass that results in visible deterioration marks. Use only a mild detergent and water solution with a soft cloth to clean Plexiglass surfaces.

The bathroom lavatory is also a molded plastic material and should be cleaned with a mild soap and water solution. Abrasive cleaners or harsh detergents should not be used.

For instructions on the care of your fresh water toilet, refer to the information in your Motor Home Operation Manual binder.

DOORS AND WINDOWS

Windows may be periodically cleaned with a good quality glass cleaner or mild soap solution using a soft cloth. Use care when removing ice or frost from the windows. Always use a plastic ice scraper, never one made of metal. Use care when removing ice from the mirrors to protect the reflective surfaces.

Door locks and hinges should be lubricated periodically with powdered graphite to ensure trouble-free operation and to protect against freeze-up.

WINDOW ROLL-UP SHADE ADJUSTMENT

If a roll-up type window shade in your motor home does not roll up or down fully, the spring tension may need adjustment.

Spring Too Weak:

- Roll shade about half-way down on window.
- Remove shade from bracket.

- Roll shade snugly by hand and replace onto bracket.

Spring Too Strong:

- Roll shade all the way up.
- Remove shade from bracket.
- Unroll shade one or two turns as necessary by hand and replace onto bracket.

PLEATED WINDOW SHADE ADJUSTMENT

Pleated shades will lose their shape if left in a lowered position for an extended period of time. If a pleated shade loses its shape, storing it in the fully raised position for a while will reshape it. We recommend that you fully raise pleated shades when they are not in use, especially in warm environments, to prevent them from losing their shape.

VEHICLE MAINTENANCE

(See also Safety Precautions, Section 1 of this manual).

CHASSIS SERVICE & MAINTENANCE

Consult the appropriate sections in your chassis operating guide for specific information regarding operating safety, service recommendations and maintenance schedules for the chassis section of your motor home.

ENGINE ACCESS

Refer to your chassis operating guide.

ENGINE COOLING SYSTEM

Refer to your chassis operating guide for information and precautions on filling, servicing and checking the fluid level.

CAUTION

When refilling the coolant system of a vehicle equipped with a rear auxiliary automotive heater and motoraid water heater, be sure to allow for additional coolant capacity of the heater and its supply and return hoses.

TIRES

Low air pressure results in tire overloading and abnormal wear and also affects handling and fuel economy. Obtain proper inflation pressures from your vehicle chassis manual or tire manufacturer.

WARNING

Radial ply tires are optional on some models. The tire option is not intended to upgrade the load rating of the entire vehicle and does not imply that GVWR and GAWR ratings may be increased over the figures found on the certification label.

Make sure all replacement tires are of the same size and ply rating as those installed as original equipment.

SUSPENSION ALIGNMENT AND TIRE BALANCE

The front suspension and steering system of this vehicle was factory aligned using highly accurate equipment prior to delivery to the dealership. However, we recommend that alignment be checked and, if necessary, adjusted after you have fully loaded the motor home according to your personal needs. Thereafter, the alignment should be periodically inspected to help prevent uneven tire wear.

Any excessive or abnormal tire wear may indicate worn or misaligned suspension or steering, unbalanced tire or other tire/suspension problem.

Alignment can be affected by worn steering/suspension parts or by incidents which happen during driving, such as hitting a curb, pothole or railroad track, etc. Improper alignment can cause tires to roll at an angle and wear unevenly. It may also cause the vehicle to "pull" to the right or left. Have your dealer inspect your vehicle's suspension and steering components periodically for misalignment or wear.

Out-of-balance tires will not roll smoothly and can lead to annoying vibrations and uneven tread wear such as cupping and flat spots. Tires may need to be balanced if uneven wear is detected or if ride comfort decreases noticeably.

See your chassis operating guide for further information.

WINDSHIELD WASHERS AND WIPERS

See your chassis operating guide for recommendations and precautions regarding washers and wipers.

LIGHTS

All exterior lights should be checked for proper operation each time the vehicle is prepared for a trip. Any bulbs which fail to light should be checked and replaced, when necessary, with a new bulb of the same size. A failure of more than one light, such as both taillights not operating, may indicate a burned out fuse. Check fuse and replace with one of the same rating when necessary. If a fuse is not the cause of the problem, the wiring system should be checked immediately by an authorized service center.

The headlight circuit is protected by a circuit breaker. An overload on the breaker will cause the lights to flicker on and off. Headlight wiring should be checked immediately anytime this condition is apparent. Refer to your chassis operating guide for further information.

AUTOMOTIVE 12-VOLT FUSES

The automotive electrical circuits are protected from short circuit and overload conditions by a fuse block. On most models, this is located beneath the dash to the left side of the steering column. See your chassis operating guide for additional fuse replacement information.

AWNING INSTALLATION

IMPORTANT

See your Winnebago or Itasca dealer for installation of awnings. Your dealer's service department has information showing locations of awning bracket supports in the sidewall of the coach.

CAUTION

Improper awning installation may result in damage to the coach.

SECTION 11

STORING YOUR MOTOR HOME

PREPARING VEHICLE FOR STORAGE

Properly preparing your vehicle for storage will lessen the possibility of damage to your vehicle. Prepare the motor home for vacancy just as you would if you were leaving your house for an extended period:

- Remove all perishables from cabinets and refrigerator.
- Prop refrigerator door open.
- Turn off LP gas tank.
- Drain water heater, water tank and holding tank.
- Close shades to protect upholstery from sunlight

When storing your vehicle through the winter, or in cold climates, extra preparations need to be made to protect systems that can be damaged by freezing temperatures.

Cold Weather Storage Procedure (Winterizing)

1. Clean and dump holding tanks by following steps A, B, and C.
 - A. Add water to the sewage holding tank by holding the toilet flush lever open with the water pump running. Add water to the waste water holding tanks by opening the kitchen, shower and lavatory faucets. Tanks should be about 1/4 to 1/3 full to rinse properly. Driving to a disposal site will normally loosen and rinse any waste material from the sides of the tanks.
 - B. Completely drain the sewage and waste water holding tanks at an approved waste disposal site. Drain the sewage tank first so the following waste water can rinse any waste solids from the dump outlet and sewer hose.
 - C. Close dump valves to prevent valve shafts from rusting and to prevent entry by rodents and insects. Refit the dust cap onto the drain outlet.
2. Level the motor home and drain the entire plumbing system as described in the following steps.
3. Open all drain valves by pulling their ring handles up about 1/2". (See the water system drain valve chart on page 7-5 for locations on your model.) To close the valves, simply push the valve shafts down until they are fully seated.

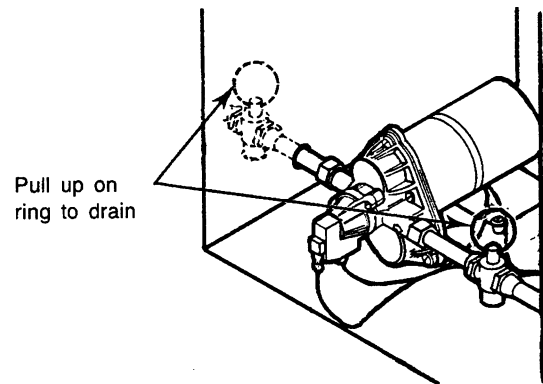

4. Turn the Water Pump switch ON to allow it to operate until you are done draining all faucets and toilet.
5. Open all faucets and shower head valves, including exterior shower.
6. Be sure the exterior shower supply valves (if equipped) are open. See page 7-6 for the location of these valves for your coach, if equipped.

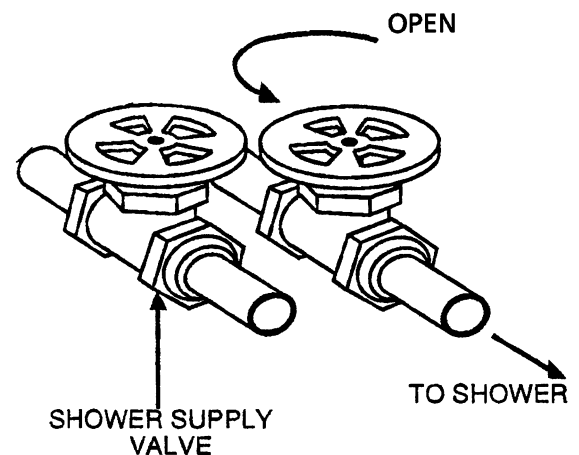

After the water lines have been drained, close the shower supply valves. (Remember to open the shower supply valves again for summer use.)

7. Operate the toilet flush lever and hold until water stops flowing in the toilet. Then turn water pump switch OFF.
8. Turn off the water heater power switch before draining the water heater tank to avoid damage to the heating element.
9. Drain the water heater by removing the plug from the base of the water heater tank, accessible from the outside of the coach.

(Requires socket and ratchet.) Also open the Pressure-Temperature relief valve at the top right portion of the tank to prevent air locking in the tank while draining.

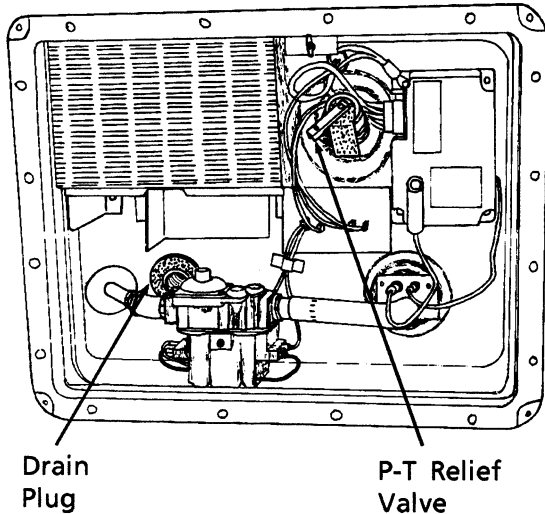

10. After water has stopped draining at all faucets and drain valves, connect a "blow-out" plug to the city water connection on the coach. Then use a hand pump or air compressor regulated to 30 psi or less to force air through the system. (A "blow-out" plug can be purchased at any Winnebago or Itasca dealer. P/N 701705-01-000.)

City Water Connection

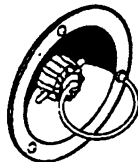

CAUTION

Limit air pressure to 30 psi to avoid damage to pump or water lines.

NOTE: DO NOT burst air into the system. This can damage the water pump. It is better to let air in slowly.

11. Let air flow for five minutes until water is completely drained out of faucets and drain valves. Then close faucets one at a time.
12. Operate and hold toilet flush lever until water is completely drained from toilet.

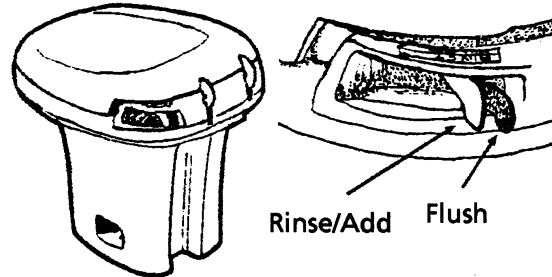

13. Now turn air pressure off and disconnect water purge adaptor. Recap the city water connection to avoid contamination by dirt or insects.
14. Close all drain valves and faucets to avoid contamination by dirt or insects. Reinstall water heater drain plug and close P-T relief valve.
15. Pour about one cup of non-toxic RV antifreeze into the kitchen sink drain, bathroom sink drain and shower drain. This prevents any holding tank odors from entering the coach during storage.

WARNING

Do not use automotive radiator antifreeze. It is poisonous.

It is not necessary to add antifreeze to the toilet since the flush valve will be closed.

Do not add automotive antifreeze or caustic chemicals such as bleach or laundry detergents into the toilet bowl or holding tanks. Although these products may have a deodorizing effect, they may damage plastic and rubber parts in the system.

NOTE: As an alternative to totally draining the plumbing system, you may winterize tanks and lines by pumping non-toxic RV antifreeze through the system. This product is available from your dealer and from most RV supply stores. Follow directions on the container to determine the correct amount to use for your coach.

16. Place a bucket beneath the sewage drain valve outlet and re-drain the sewage and waste holding tanks of any clean water that entered during "blow-out" procedure. Close dump valves to prevent valve shafts from rusting and to prevent entry by rodents and insects. Refit the dust cap onto the drain outlet.

Your drainage and fresh water systems are now totally winterized.

17. Have the vehicle chassis completely serviced and lubricated. Be sure radiator antifreeze protection level is sufficient for the lowest anticipated temperatures.
18. Wash and wax the coach.
19. Inspect all seams and seal around doors, windows, vents, and any other joints. Replace or repair any that are damaged. Sealing materials and compounds can be purchased from your dealer. Badly damaged weather seals may need to be replaced by your dealer.
20. Close all windows and roof vents. Protect all appliance vent openings from contamination by animals or insects (e.g. bird nests, wasp nests, etc.)
21. Lubricate all door hinges and locks.
22. Clean the interior of the coach. Dirt and stains are more easily removed when fresh.
23. Remove all foods and items that may cause odors.
24. Clean and defrost the refrigerator. Leave the door slightly ajar to allow any odors to dissipate. Place an open box of baking soda inside the refrigerator to help absorb odors.
25. Turn the furnace thermostat switch on the bottom of the thermostat to OFF.
26. Disconnect all chassis and auxiliary battery cables.
27. Fully charge all batteries. Batteries must have at least 80% charge to survive freezing temperatures and long periods of non-use.

REMOVAL FROM STORAGE

1. Completely air out the motor home.
2. Have the entire LP gas system checked for leaks.
3. Check window operation.
4. Check cabinet and door hinges. Lubricate with penetrating oil, if necessary.
5. Close all faucets and drain valves that are open. If necessary, reconnect toilet water line and close flush valve.

6. Add a few gallons of water to the fresh water tank and check for leaks especially at junctions. Also make sure all hangers and supports are securely in place. Sanitize the water system as outlined under "Disinfecting the Fresh Water System" in Section 7.
7. Check operation of all faucets to be sure faucet washers have not hardened during storage.
8. Check sealing valve in the toilet for proper operation and lubricate with silicone spray.
9. Add water to the holding tank using the toilet flush pedal. Check to be sure dump valve seals tightly.
10. Check around all appliances for obstructions and ensure that all vent openings are clear.
11. Start refrigerator and check for proper cooling.
12. Clean paneling and counter surfaces and apply a thin coat of wax.
13. Replace batteries if necessary and check out electrical system to make sure all lights and electrical components operate.
14. Check tires for proper cold inflation pressure.
15. After washing accumulated winter grime from the vehicle, it is important to carefully inspect the seams and sealants for separation or cracks that may have appeared around the window frames, vents and any other joints. Re-sealing is quite simple and the material is quickly and easily applied. Appropriate compounds are available from your dealer. Also, inspect weather seals around doors, etc., and if necessary, have a dealer replace immediately.

INDEX

A

Air Conditioner 2-7, 8-8
Alarm, Carbon Monoxide..... 1-4
 LP Gas..... 1-2
 Smoke 1-5
Alignment, Suspension and Tire Balance10-4
Antenna..... 8-8
Arm Rest Adjustment..... 2-3
Audio System - Radio/Cassette 2-7
Aux. Start Switch..... 2-7
Auxiliary Generator 110-Volt..... 6-3, 6-4
Auxiliary Generator Hourmeter..... 6-4
Awning Installation 10-4

B

Bathroom, Care of..... 10-3
Battery Charger, connecting..... 3-3
Battery Condition Meter..... 6-6
Battery Maintenance 6-6
Beds, Converting for use 9-1
Before Driving Your Vehicle 2-1
Before Entering Your Vehicle 2-1
Brake, Parking..... 2-2
Bunk, Front Overhead..... 9-1

C

Cabinets, cleaning..... 10-2
Cable TV Hook-Up..... 8-9
Campsite Set-Up 4-5
Capacities:
 Fresh Water Tank 7-1
 Fuel Tank..... 2-2
 Holding Tanks 7-4
 Water Heater..... 8-5
Carbon Monoxide Alarm..... 1-4
Carbon Monoxide Warning 1-3
Carpets, Care of..... 10-2
Chassis Service..... 10-3
Checklists
 Pre-Travel..... 4-2
 Emergency Equipment..... 4-2
 Quick Loading 4-2

Circuit Breakers, 12-Volt:

City Water Hook-Up..... 7-3
Clock, Quartz Wall-Mounted 9-2
Coach Battery Access..... 6-5
Coffee Maker, cleaning..... 9-2
Cold Weather Storage..... 11-1
Comfort Controls 2-7
Converter, AC-DC Power..... 6-2
Cooling System, Engine..... 10-3
Couch/Bed Conversion 9-1

D

Decal and Stripes, care of..... 10-1

Defects, Reporting Safety..... ii
Dinette/Bed Conversion..... 9-1
Disinfecting Water System 7-2
Door Handles and Locks..... 2-3
Doors and windows, Care of..... 10-3
Drain Valves..... 7-5
Drainage System (Sewage)..... 7-3
Drains, Water System..... 7-5
Draperies, Care of..... 10-2
Drinking and Driving ii
Driving Safety Precautions..... 1-1
Dual Rear Wheels 3-2
Dump Valves, Sewage 7-3, 7-4

E

Electrical Outlets, 110-Volt..... 6-3
Electrical Safety Precautions..... 1-3
Electrical System, 110-Volt AC..... 6-1
Electrical System, 12-Volt DC..... 6-4
Emergency Equipment Checklist 4-2
Emergency Exit Window..... 1-4
Engine Access 10-3
Engine Cooling System 10-3
Engine Overheat..... 3-5
Engine, Starting and Stopping the..... 2-2
Entering Your Vehicle, Before 2-1
Entertainment Center, exterior 8-10
Exterior Body Care..... 10-1
Exterior Feature Identification v, vi
Exterior Shower..... 7-3
External Power Cord (Shoreline)..... 6-1

F

Fire Extinguisher..... 1-4
Formaldehyde Warning..... 1-2
Fresh Water Tank..... 7-1
Fuel Caps, Replacement..... 2-2
Fuel Pump Shut-Off Switch..... 2-2
Fuel Selection, Vehicle..... 2-2
Fuel Safety Precautions..... 1-1
Fuel Tank, Filling Vehicle..... 2-2
Furnace, LP Gas..... 8-8
Fuses, 12-Volt 6-5, 10-4

G

Gas Alarm, LP..... 1-2
General Warnings..... 1-1
Generator, Auxiliary 110-Volt 6-3, 6-4
Generator Hourmeter..... 6-4
Ground Fault Circuit Interrupter (GFCI) 6-3

H

Hazard Flashers 2-2, 3-1
Heater/Defroster 2-7
Heater, Rear Automotive..... 2-7
Holding Tank, Dumping 7-3

| | | | | |
|--|----------|---|----------------------------|-----|
| Holding Tank Level Indicators..... | 7-4 | Q | Quick Load Checklist..... | 4-2 |
| Hood, Engine..... | 10-3 | R | Radio/Cassette Player..... | 2-7 |
| Hourmeter, Auxiliary Generator..... | 6-5 | Range..... | 8-3 | |
| Humidity & Condensation..... | 4-4 | Range Hood..... | 8-5 | |
| I | | Range Maintenance..... | 10-3 | |
| Instrument Panel..... | 2-6 | Rear Automotive Heater..... | 2-7 | |
| Interior Care..... | 10-1 | Recovery Towing..... | 3-2 | |
| J | | Refrigerator..... | 8-1 | |
| Jump Starting..... | 3-2 | Regulator, LP Gas..... | 5-2 | |
| K | | Relief Valve, Water Heater..... | 8-7 | |
| Keys..... | 2-1 | Removal From Storage..... | 11-2 | |
| L | | Reporting Safety Defects..... | ii | |
| Lights, Replacing Interior..... | 10-4 | Restraints, Child..... | 2-5 | |
| Loading, Roof..... | 4-1 | Roof Loading..... | 4-1 | |
| Loading Safety Precautions..... | 1-3 | Roof Maintenance..... | 10-1 | |
| Loading the Vehicle..... | 4-1 | Roof Vent, Power..... | 9-2 | |
| Locks..... | 2-3 | S | | |
| Lounge Chair..... | 2-4 | Safety Defects, Reporting..... | ii | |
| LP Gas Alarm..... | 1-2 | Sanitizing Water Tank (Disinfection)..... | 7-1 | |
| LP Gas Furnace..... | 8-8 | Seat Belts and Child Restraints..... | 2-4, 2-5 | |
| LP Gas, How it Works..... | 5-1 | Seats..... | 2-3 | |
| LP Gas Leaks..... | 1-2, 5-3 | Service and Assistance..... | i, 10-3 | |
| LP Gas Level, checking..... | 8-5 | Sewer Systems (Hook-Up)..... | 7-4 | |
| LP Gas Pressure Regulator..... | 5-2 | Shade Adjustment..... | 10-3 | |
| LP Gas Safety Precautions..... | 1-1 | Shoreline Power Cord (Hook-Up)..... | 6-1 | |
| LP Gas Selection..... | 5-1 | Shower, Exterior..... | 7-3 | |
| LP Gas System, Safe Use of..... | 5-1 | Shower Valve Pressure Bleed-Off..... | 7-2 | |
| LP Gas Tank..... | 5-2 | Signal Amplifier, TV..... | 8-9 | |
| LP Gas Tank, Air in the..... | 5-2 | Sink, Fold-Up Lavatory..... | 9-1 | |
| LP Gas Tank Filling..... | 5-2 | Sink, Stainless Steel..... | 10-3 | |
| LP Gas, Traveling with..... | 5-2 | Slider Windows..... | 9-2 | |
| LP Gas, Winter Use of..... | 5-3 | Smoke Alarm..... | 1-4 | |
| LP Gas Works, How..... | 5-1 | Spare Tire..... | 3-1 | |
| M | | Start Switch, Aux..... | 2-7 | |
| Microwave Oven..... | 8-4 | Starting and Stopping the Engine..... | 2-2 | |
| Mirrors, Rear and Side View..... | 2-5 | Storage, Cold Weather..... | 11-1 | |
| Monitor Panel..... | 8-5 | Storage, Remove From..... | 11-3 | |
| Motor Home Operations Manual (Binder)..... | i | Stripes and Decals, care of..... | 10-1 | |
| Motor-Aid Water Heater..... | 8-7 | Suspension Alignment..... | 10-4 | |
| Mountain Driving..... | 4-5 | T | | |
| N | | Tables..... | 10-2 | |
| Nighttime Driving..... | 4-5 | Thermal Breaker, Power Converter..... | 6-2 | |
| O | | Tires..... | iii, 10-3 | |
| Outlets, 110-Volt..... | 6-3 | Tire Balancing..... | 10-3 | |
| Oven..... | 8-3 | Tire Changing..... | 3-1 | |
| Oven, Microwave..... | 8-4 | Toilets..... | 9-2 | |
| Oven Pilot..... | 8-4 | Towing Your Vehicle..... | 3-2 | |
| Overheated Engine..... | 3-3 | Trailer Towing..... | 4-1 | |
| P | | Trailer Wiring Connector..... | 6-6 | |
| Parking Brake (Emergency Brake)..... | 2-2 | Travel Tips..... | 4-3 | |
| Power Roof Vent..... | 9-2 | TV Antenna..... | 8-8 | |
| Power Converter, 110V-to-12V..... | 6-2 | TV Cable Hook-Up..... | 8-9 | |
| Pre-Travel Checklist..... | 4-2 | TV Signal Amplifier..... | 8-9 | |
| Pressure Regulator (LP Gas)..... | 5-3 | | | |
| Pump Switch, Water..... | 8-5 | | | |

U

Upholstery Carpeting and Draperies..... 10-1
Under-Body Cleaning..... 10-1

V

Vehicle Certification Label..... iii
Vent, Power Roof..... 9-2

W

Warnings

Carbon Monoxide..... 1-3
Driving 1-1
Electrical..... 1-3
Formaldehyde 1-3
Fuel 1-1, 2-2
General 1-1
Generator, Auxiliary..... 6-4
LP Gas..... 1-1, 5-1
Loading 1-3
Maintenance 1-3

Warranty ii

Waste Drainage System 7-3
Water Pump..... 7-1
Water Pump Switch 8-5
Water Heater 8-6
Water Heater, Motor-Aid 8-7
Water Heater Relief Valve 8-7
Water Hook-Up, External (City) 7-2
Water, Shower Valve Bleed-Off..... 7-2
Water System, Disinfection of..... 7-1
Water System, Fresh..... 7-1
Water Tank, Filling Instructions..... 7-1
Water Tank Drain Valve Locations..... 7-5
Weather Information, Severe 4-4
Weighing the Vehicle 4-1
Wheel Nuts 3-2
Window Cleaning 10-3
Window Shades 10-3
Windows, Slider..... 9-2
Windows, Emergency Exit..... 1-4
Windshield Wiper/Washer 10-4
Winterizing..... 11-1

IMPORTANT SERIAL NUMBERS

Motor Home (Coach): Year _____ Model _____ Serial _____
Chassis: Make _____ Serial (VIN) _____

| | | | |
|------------------------|-------------|-------------|--------------|
| Roof Air Conditioner: | Brand _____ | Model _____ | Serial _____ |
| Furnace: | Brand _____ | Model _____ | Serial _____ |
| Water Heater: | Brand _____ | Model _____ | Serial _____ |
| Power Converter: | Brand _____ | Model _____ | Serial _____ |
| 110-Volt Generator: | Brand _____ | Model _____ | Serial _____ |
| Range: | Brand _____ | Model _____ | Serial _____ |
| Microwave Oven: | Brand _____ | Model _____ | Serial _____ |
| Refrigerator: | Brand _____ | Model _____ | Serial _____ |
| Television: | Brand _____ | Model _____ | Serial _____ |
| Video Cassette Player: | Brand _____ | Model _____ | Serial _____ |

EMERGENCY INFORMATION

Dealer

Name _____

Address _____

Phone _____

INSURANCE POLICY

Company _____

Policy Number _____

Phone _____

