





# TABLE OF CONTENTS

---

## 1 – INTRODUCTION

About this Manual .....	1-1
Safety Messages Used in this Manual .....	1-1
Pre-Delivery Inspection .....	1-2
Before Driving .....	1-2
Front Axle Tire Alignment .....	1-2
Service and Assistance .....	1-2
Reporting Safety Defects .....	1-2
Occupant and Cargo Carrying Capacity Label .....	1-3
Vehicle Certification Label .....	1-4
Specifications and Capacities .....	1-5
Owner and Vehicle Information .....	1-6

## 2 – SAFETY AND PRECAUTIONS

General Warnings .....	2-1
Driving Safety .....	2-1
Fuel and Propane Gas .....	2-2
Propane Gas Leaks .....	2-3
Propane Gas Leak Detector .....	2-3
Carbon Monoxide Warning .....	2-4
Carbon Monoxide Alarm .....	2-4
Smoke Alarm .....	2-5
Fire Extinguisher .....	2-6
Electrical .....	2-6
Loading .....	2-6
Maintenance .....	2-7
Emergency Exits .....	2-7
Power Sofas and Beds .....	2-7
Slideout Rooms .....	2-7
Formaldehyde Information .....	2-8
Mold, Moisture, and Your Motorhome .....	2-8
Roof .....	2-9
Roadside Emergency .....	2-9
Jump Starting .....	2-10
Engine Overheat .....	2-10

## 3 – DRIVING YOUR MOTORHOME

Seats – Driver/Co-Pilot .....	3-1
Seat Belts .....	3-3
KeyOne™ Lock System .....	3-4
Power Door Locks .....	3-4
Accent LED Light Strips (Front) .....	3-6

---

## Table Of Contents

---

Collision Avoidance System .....	3-6
Mirrors – Power Electric .....	3-7
Front Drop-Down Solar/Night Shade (12-Volt) .....	3-8
Infotainment Center/GPS .....	3-9
Infotainment Center/GPS .....	3-11
CB Radio Power Wiring .....	3-14
Parking Brake .....	3-14
Engine Brake System .....	3-14
Tag Axle Suspension System .....	3-15
Headlight Switch .....	3-16
Hazard Warning Flashers .....	3-16
Signal Lever/Headlight High-Low Beam .....	3-17
Steering Column Adjustment .....	3-18
Brake/Accelerator Pedals – Adjustable .....	3-18
SmartWheel™ Steering Wheel Control System .....	3-19
Battery Boost Switch .....	3-21
Air Conditioner/Heater – Automotive (Dash) .....	3-22
Defrost Fans .....	3-22
Air Horns .....	3-23
Fuel Selection – Diesel Engine .....	3-23
Filling the Fuel Tank – Diesel Engine .....	3-23
Starting and Stopping Diesel Engine .....	3-23
Engine Block Heater – Diesel Engine .....	3-24
Engine Service Access Grille – Rear .....	3-24
Engine Access Covers – Rear Bath .....	3-25
Fuel/Water Separator – Diesel .....	3-27
Diesel Exhaust Fluid Fill .....	3-27
Engine Cooling System .....	3-28
Chassis Battery Disconnect Switch .....	3-28
Circuit Breakers and Fuses – Chassis/Dash Automotive 12-Volt .....	3-29
Front Service Access .....	3-30
Windshield Washers and Wipers .....	3-31
Tires .....	3-31
Hub Cover .....	3-31
Suspension Alignment and Tire Balance .....	3-32
Lights .....	3-32

## 4 – APPLIANCES AND SYSTEMS

Refrigerator – Residential .....	4-1
Ice Maker .....	4-2
Refrigerator Service Access Compartment – Residential .....	4-3
Tailgate Package .....	4-3
Refrigerator/Freezer – Portable .....	4-4
Range Top (Electric) .....	4-4
Microwave/Convection Oven With Range Hood .....	4-5

---

## Table Of Contents

---

Monitor Panel .....	4-5
Monitor Panel (Touch Tablet) .....	4-6
Power Control System (PCS) .....	4-8
Solar Charge Panel .....	4-8
Thermostat (Touch Tablet) .....	4-10
Hydronic Heating System .....	4-12
Air Conditioner Filters .....	4-15
Washer/Dryer – Stackable .....	4-16
Washer/Dryer – Prep Package .....	4-17
Dishwasher .....	4-17
Central Vacuum Cleaner .....	4-18
<b>5 – PROPANE GAS</b>	
Propane Gas Supply – Removable .....	5-1
Propane Accessory Connection .....	5-2
Safe Use of the Propane Gas System .....	5-3
Propane Gas Warnings and Precautions .....	5-4
Propane Gas Pressure Regulator – Removable LP Tank .....	5-5
Propane Vaporization in Cold Weather .....	5-6
<b>6 – ELECTRICAL</b>	
Electrical Cautions .....	6-1
Electrical System – House 120-Volt AC .....	6-1
Power Cord – External .....	6-1
Power Cord Reel .....	6-3
Inverter/Charger Unit – 2800W (Pure Sine Wave) .....	6-4
Circuit Breakers – House 120-Volt AC .....	6-5
Electrical Outlets – House 120-Volt AC .....	6-6
Ground Fault Circuit Interrupter .....	6-6
Electrical Generator .....	6-7
Electrical System – House 12-Volt DC .....	6-9
Battery Information .....	6-10
House/Coach Battery Disconnect Switch .....	6-10
Battery Access .....	6-10
Battery Care .....	6-11
Circuit Breakers – House 12-Volt .....	6-13
<b>7 – PLUMBING</b>	
Fresh Water System .....	7-1
Water Pump .....	7-3
Cold Water Filter .....	7-5
Cold Water Filter .....	7-6
Ice Maker Water Filter .....	7-7
Full-Coach Water Filtration System .....	7-7
Disinfecting Your Fresh Water System .....	7-8
Shower Hose Vacuum Breaker .....	7-10

---

## Table Of Contents

---

Exterior Shower/Wash Station .....	7-10
Toilet .....	7-10
Toilet – Electric Flush .....	7-10
Drainage System (P-Traps) .....	7-11
Waste Water System .....	7-11
Utility Light .....	7-14
WaterLine and Tank Drain Valves .....	7-15
Winterizing Procedure .....	7-16
Winterizing Optional Appliances .....	7-18
Water System Drain Valve Locations .....	7-21
<b>8 – ENTERTAINMENT</b>	
HDMI Video Selection System .....	8-1
HDMI Video Selection System .....	8-2
Front TV Ignition Switch Interlock .....	8-3
Audio/Video System Basic Operation .....	8-3
Sound Bar System .....	8-3
Bose® Sound Bar System .....	8-4
Yamaha® Sound Bar System .....	8-5
Infotainment Center (House Mode) .....	8-6
TV (Dining Buffet) – Power Lift .....	8-7
TV Antenna – Digital .....	8-8
TV Antenna – Digital .....	8-9
TV Signal Amplifier .....	8-10
Satellite Dish and Cable TV Connections (Input) .....	8-10
TV Digital Satellite System Wiring .....	8-10
TV Digital Satellite System – Automatic .....	8-11
Exterior Entertainment Center (Adjustable) .....	8-12
<b>9 – FURNITURE AND SOFTGOODS</b>	
Lounge Chair – Swivel .....	9-1
Sliding Buffet Table and Chairs .....	9-1
Sleeping Facilities .....	9-3
Sofa/Dinette (Super Lounge) .....	9-3
Sofa/Sleeper .....	9-5
Extendable Sectional Sofa/Sleeper .....	9-7
Digital Sleep Air Bed .....	9-9
Bed – Power Lift .....	9-9
Power Shades – Night (12-Volt) .....	9-10
Roller Shades (Manual) – Solar/Blackout .....	9-11
Wood Furniture and Cabinetry .....	9-12
<b>10 – SLIDEOUT ROOMS AND LEVELING</b>	
Slideout Room Lock System .....	10-1
Slideout Room Travel Locks – Electric .....	10-1
Slideout Room Retraction (with Power Lift Bed) .....	10-2

---

## Table Of Contents

---

Slideout Room Operation – Electric .....	10-3
Slideout Room – Extreme Weather Precaution .....	10-5
Slideout Room Troubleshooting (Power Gear®) In Wall Slideout .....	10-6
Slideout Room Troubleshooting (Power Gear®) Under Floor Slideout .....	10-6
Slideout Emergency Retraction (Power Gear®) In Wall Slideout .....	10-8
Slideout Emergency Retraction (Power Gear®) Under Floor Slideout .....	10-8
Slideout Emergency Retraction – Bedroom (Power Gear®) .....	10-9
General Slideout Care .....	10-10
Leveling System (Hydraulic) .....	10-10
Leveling System (Air and Hydraulic) .....	10-13
Checking Hydraulic Oil Level (HWH®) .....	10-15
<b>11 – MAINTENANCE AND STORAGE</b>	
Sealants – Inspection and General Information .....	11-1
Roof .....	11-1
Undercarriage .....	11-1
Exterior Automotive Paint Finish .....	11-2
Exterior Graphic Care .....	11-4
Front End Masks and Paint Damage .....	11-4
Headlights and Exterior Lights .....	11-5
Plastic Parts – Cleaning .....	11-5
Interior Soft Goods .....	11-6
Cabinetry – Cleaning .....	11-7
Decorative Vinyl Wall Paneling – Cleaning .....	11-7
Solid Surface Countertop – Corian® .....	11-7
Solid Surface Countertop – Quartz .....	11-8
Stainless Steel Appliances .....	11-9
Sink – Stainless Steel .....	11-10
Range and Refrigerator .....	11-10
Ceramic Tile – Polished .....	11-10
Bathroom .....	11-10
Doors and Windows .....	11-11
Vehicle Storage – Preparation .....	11-11
Vehicle Storage – Removal .....	11-12
Chassis Service and Maintenance .....	11-13
Chassis Fuses and Relays .....	11-13
Chassis Diagnostic Connectors .....	11-14
Coach Maintenance Chart .....	11-15
<b>12 – MISCELLANEOUS</b>	
Loading the Vehicle .....	12-1
Weighing Your Loaded Vehicle .....	12-1
Car or Trailer Towing .....	12-3
Trailer Wiring Connector .....	12-4
Towing Guidelines .....	12-4
Fireplace .....	12-5

---

## Table Of Contents

---

Fireplace .....	12-6
Fireplace .....	12-7
Countertop Extension .....	12-8
Step (Entry) – Electric .....	12-9
Stepwell Cover .....	12-10
Windows .....	12-11
Power Roof Ventilator .....	12-12
Skylight Shade .....	12-14
Storage Compartment Doors .....	12-14
Compartment Lights Switch .....	12-14
Awning – Power .....	12-15
Air Hose Connector .....	12-17
Effects of Prolonged Occupancy .....	12-18

---



# SECTION 1 – INTRODUCTION

---

Congratulations! We welcome you to the exciting world of motorhome travel and camping. You will find it convenient and enjoyable to have all the comforts of home and still enjoy the great outdoors wherever you choose to go.

Before sliding into the driver's seat, please become familiar with operations and features. In addition, spend some time with the dealer when you take delivery to learn all you can about your new motorhome.

---

---

## ABOUT THIS MANUAL

This operator's manual was prepared to aid you in the proper care and operation of the vehicle and equipment.

Please read this manual completely to understand how everything in your coach works before taking it on its "maiden voyage". In addition, please become familiar with the New Vehicle Limited Warranty.

*NOTE: This manual describes many features of your motorhome and includes instructions for its safe use.*

*This manual, including photographs and illustrations, is of a general nature only.*

***Some equipment and features described or shown in this manual may be optional or unavailable on your model.***

*Because of Winnebago Industries<sup>®</sup>, continuous program of product improvement, it is possible that recent product changes and information may not be included.*

*The instructions included in this manual are intended as a guide, and in no way extend the responsibilities of Winnebago Industries beyond the standard written warranty as presented in this manual.*

*The descriptions, illustrations, and specifications in this manual were correct at the time of printing. We reserve the right to change specifications or*

*design without notice, and without incurring obligation to install the same on products previously manufactured.*

The materials in your InfoCase contain warranty information and operating and maintenance instructions for the various appliances and components in your motorhome.

*NOTE: Many of the instruction sheets and manuals for the various appliances and components have been incorporated into the Operator's Manual Supplement for your convenience.*

*Please read the FAQ in Section 1 of the Operator's Manual Supplement for more details.*

Throughout this manual, frequent reference is made to the vehicle chassis manual that is provided by the manufacturer of the chassis on which this motorhome is built.

Consult the chassis manual for operating, safety, and maintenance instructions pertaining to the chassis section of the motorhome.

---

---

## SAFETY MESSAGES USED IN THIS MANUAL

Throughout this manual, certain items are labeled Danger, Warning, Caution, Notice, or Note. These terms alert you to precautions that may involve damage to your vehicle or a risk to your personal safety. Read and follow them carefully.



DANGER indicates a hazardous situation which, if not avoided, will result in death or serious personal injury.

# SECTION 1 – INTRODUCTION

---



## WARNING

WARNING indicates a hazardous situation which, if not avoided, could result in death or serious personal injury.



## CAUTION

CAUTION indicates a hazardous situation which, if not avoided, could result in minor or moderate personal injury.

## NOTICE

NOTICE is used to address practices not related to personal injury.

*NOTE: A “Note” is not necessarily safety-related, but indicates a recommendation or special point of information that could assist in understanding the use or care of a feature item.*

---

## PRE-DELIVERY INSPECTION

This motorhome has been thoroughly inspected before shipment. Your dealer is responsible for performing a complete pre-delivery inspection of the chassis and all motorhome components.

As a part of the pre-delivery inspection procedure, the dealer is responsible for road testing the motorhome, noting, and correcting any problems before delivery.

---

## BEFORE DRIVING

Familiarize yourself with State/Province and local regulations before traveling. There are many local rules that may impact your RV travels.

---

## FRONT AXLE TIRE ALIGNMENT

We recommend that you have the front suspension and steering alignment checked and adjusted after you have fully loaded the vehicle according to your needs. Thereafter, have alignment inspected periodically to maintain vehicle steering performance and prevent uneven tire wear.

---

## SERVICE AND ASSISTANCE

Your dealer will be glad to provide any additional information you need, as well as answer any questions you might have about operating the equipment in your coach. When it comes to service, remember that your dealer knows your vehicle best and is interested in your satisfaction. Your dealer will provide quality maintenance and any other assistance that you may require during your ownership of this vehicle.

If you need warranty repairs while traveling, you may take your vehicle to any authorized Winnebago Industries® dealership and request their assistance.

See the Service Dealer Directory in your InfoCase.

---

## REPORTING SAFETY DEFECTS

If you believe that your vehicle has a defect which could cause a crash or could cause injury or death, you should immediately inform the National Highway Traffic Safety Administration (NHTSA) in addition to notifying Winnebago Industries, Inc.

If NHTSA receives similar complaints, it may open an investigation, and if it finds that a safety defect exists in a group of vehicles, it may order

a recall and remedy campaign. However, NHTSA cannot become involved in individual problems between you, your dealer, or Winnebago Industries, Inc.

To contact NHTSA, you may either call the Vehicle Safety Hotline toll-free at: 1-888-327-4236; (TTY: 1-800-424-9153) or go to <http://www.safercar.gov> or write to:

Administrator, NHTSA  
1200 New Jersey Avenue S.E.  
Washington, D.C. 20590



You can also obtain other information about motor vehicle safety at <http://www.safercar.gov>.

---

---

## OCCUPANT AND CARGO CARRYING CAPACITY LABEL

This label is affixed in the driver's area next to or near the Vehicle Certification Label. It contains vehicle occupant and cargo carrying capacity along with the number of seat belt positions in the vehicle. The label also provides the weight of a full load of water and advises that this weight, along with the tongue weight counts as cargo.

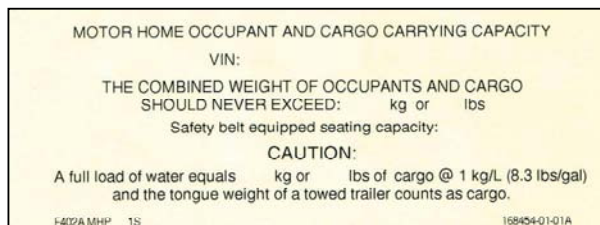

If any weight exceeding 45.4 kg (100 lbs.) is added to your coach between final vehicle certification and first retail sale, the occupant and cargo carrying capacity must be corrected and a label similar to the one shown below will be affixed inside your coach.

# SECTION 1 – INTRODUCTION

## VEHICLE CERTIFICATION LABEL

This label is affixed to the lower driver side armrest panel, driver door, or the driver side door jamb, depending on model. It contains vehicle identification numbers and other important reference information.

MANUFACTURED BY WINNEBAGO IND. INC.			3	INCOMPLETE VEHICLE MANUFACTURED BY			1	2			
			GVWR			4	LB			KG	
GAWR:			SUITABLE TIRE AND RIM CHOICE			COLD INFLATION PRESSURE					
FRT	5	LB	KG	6	TIRE	7	RIM	8	PSI	KPA	9
RR		LB	KG					PSI	KPA		

THIS VEHICLE HAS BEEN COMPLETED IN ACCORDANCE WITH THE PRIOR MANUFACTURER'S IVD, WHERE APPLICABLE. THIS VEHICLE CONFORMS TO ALL APPLICABLE FEDERAL MOTOR VEHICLE SAFETY STANDARDS IN EFFECT ON THE DATE OF MANUFACTURE SHOWN ABOVE.

SERIAL NO.	10	VIN	11	TYPE	12	COLOR	13
XXXXX XXXX XX XX/XX/XX XXX-XXXXX			14		15	XXXXXX-XXX	

### EXPLANATION OF DATA

1. Chassis manufacturer.
2. Chassis manufacture date.
3. Month and year of manufacture at Winnebago Industries®.
4. Gross Vehicle Weight Rating: Total permissible weight of the vehicle, including driver, passengers, total cargo carried (including all liquids), and equipped with all options.
5. Gross Axle Weight Rating: Total permissible weight allowed for the front and rear axles (listed in pounds and kilograms).
6. Suitable Tire Choice: Tires recommended to meet handling and safety requirements. When replacing any of the tires on your vehicle, always replace with a tire that meets these specifications.
7. Suitable Rim Choice: Wheel rims recommended to meet handling and safety requirements. When replacing any of the rims on your vehicle, always replace with a rim that meets these specifications.
8. Cold Inflation Pressure: Inflation pressures at Gross Axle Weight Ratings recommended (while cold) for the tires originally equipped on your vehicle. These pressure levels must be maintained to assure proper handling, safety, and fuel economy.
9. Rear Axle Wheel Configuration: Single or Dual as it relates to the inflation.
10. Serial Number: This is the serial number assigned to the completed vehicle by Winnebago Industries.
11. Vehicle Identification Number (VIN): This number identifies the chassis on which the motorhome is built. The 10th digit of the VIN designates the chassis model year (F=2015, G=2016, H=2017 etc.). This information is useful when ordering chassis repair parts.
12. Type: States the NHTSA designated usage classification for your motorhome. MPV signifies a Multi-purpose Passenger Vehicle.
13. Color: Signifies the color code number of the decor used throughout the vehicle. This number is necessary for ordering replacement cushions, curtains, carpet, etc.
14. Winnebago® model year and series/family name.
15. Model: Lists the Winnebago product model number of your vehicle.

**SPECIFICATIONS AND CAPACITIES**

	<b>42HL</b>	<b>42QL</b>	<b>45RL</b>
	<b>Freightliner® Maxum Tag 45,660 lb. Chassis</b>	<b>Freightliner® Maxum Tag 45,660 lb. Chassis</b>	<b>Freightliner® Maxum Tag 45,660 lb. Chassis</b>
Feature Number	1DM	1DM	1DM
Length	43'	43'	44'
Exterior Height <sup>1</sup>	12' 10"	12' 10"	12' 11"
Exterior Width <sup>2</sup>	8' 5.5"	8' 5.5"	8' 5.5"
Exterior Storage <sup>3</sup>	196 cu. ft.	196 cu. ft.	210 cu. ft.
Awning Length	16' / 19'	16' / 19'	17' / 19"
Interior Height	7'	7'	7'
Interior Width	8' 0.5"	8' 0.5"	8' 0.5"
Freshwater Tank Capacity <sup>4</sup>	85 gal.	85 gal.	85 gal.
Water Heater Capacity	Continuous	Continuous	Continuous
Holding Tank Capacity - Black <sup>4</sup>	51 gal.	51 gal.	51 gal.
Holding Tank Capacity - Gray <sup>4</sup>	95 gal.	71 gal.	95 gal.
Propane Capacity <sup>5</sup>	5.6 gal.	5.6 gal.	5.6 gal.
Wheelbase	279"	279"	291"
GVWR	45,660 lbs.	45,660 lbs.	45,660 lbs.
GAWR - Front	15,660 lbs.	15,660 lbs.	15,660 lbs.
GAWR - Rear	30,000 lbs.	30,000 lbs.	30,000 lbs.
GCWR <sup>6</sup>	60,660 lbs.	60,660 lbs.	60,660 lbs.
Fuel Capacity	150 gal.	150 gal.	150 gal.

**Notes:**

All information is based upon the most recent data available. Visit the Winnebago Industries, Inc. web page – [www.winnebagoind.com](http://www.winnebagoind.com) – for the most current product information.

<sup>1</sup> The height of each model is measured to the top of the tallest standard feature and is based on the curb weight of a typically equipped unit. The actual height of your vehicle may vary by several inches depending on chassis or equipment variations. Contact your dealer for further information.

<sup>2</sup> Floorplans feature a wide-body design - over 96". You should be aware that some states restrict access on some or all state roads to 96" in body width. You should confirm the road usage laws in the states of interest to you.

<sup>3</sup> The load capacity of your motor home is designated by weight, not by volume, so you cannot necessarily use all available space when loading your motor home.

<sup>4</sup> Capacities are based on measurements prior to tank installation. Slight capacity variations can result upon installation.

<sup>5</sup> Capacities shown are the tank manufacturer's listed water capacity (W.C.). Actual filled propane capacity is 80% of listing due to overfilling prevention device on tank.

<sup>6</sup> Actual towing capacity is dependent on your particular loading and towing circumstances which includes the GVWR, GAWR, and GCWR as well as adequate trailer brakes. Refer to the chassis operator's manual of your motor home for further towing information.

**SECTION 1 –  
INTRODUCTION**

---

---

**OWNER AND VEHICLE INFORMATION**

**OWNER INFO**

Owner's Name(s) \_\_\_\_\_

Address \_\_\_\_\_

\_\_\_\_\_

**VEHICLE INFORMATION**

Motorhome Model Number \_\_\_\_\_

Motorhome Serial Number \_\_\_\_\_

Chassis Vehicle Identification No. (VIN) \_\_\_\_\_

Vehicle Mileage at Delivery \_\_\_\_\_

Selling Dealer Name \_\_\_\_\_

Address \_\_\_\_\_

\_\_\_\_\_

**YOUR WINNEBAGO INDUSTRIES® DEALER /SERVICE CENTER**

Name \_\_\_\_\_

Address \_\_\_\_\_

\_\_\_\_\_

Contact \_\_\_\_\_ Phone \_\_\_\_\_

**CHASSIS SERVICE CENTER**

Name \_\_\_\_\_

Address \_\_\_\_\_

\_\_\_\_\_

Contact \_\_\_\_\_ Phone \_\_\_\_\_

**RV INSURANCE POLICY**

Company \_\_\_\_\_

Policy Number \_\_\_\_\_

Agent \_\_\_\_\_ Phone \_\_\_\_\_

## SECTION 2 – SAFETY AND PRECAUTIONS



### GENERAL WARNINGS

- Only seats equipped with seat belts are to be occupied while the vehicle is moving.
- Make sure all passengers have seat belts fastened. Lap belts should fit low on the hips and upper thighs. The shoulder belt should be positioned snug over the shoulder.
- For pregnant women: Never place the shoulder belt behind your back or under your arm. Adjust the lap belt across your hips/pelvis, and below your belly. Place the shoulder belt across your chest (between your breasts) and away from your neck.
- Child restraints should be installed properly according to manufacturer's instructions. See "Child Restraints".
- All moveable or swiveling seats should be placed and locked in travel position while the vehicle is moving.
- Never let passengers stand or kneel on seats while the vehicle is moving.
- Sleeping facilities are not to be utilized while vehicle is moving.
- Examine the escape window and be familiar with its operation.
- Inspect the fire extinguisher monthly for proper charge and operating condition. This should also be done before beginning a vacation or any extended trip.

### DRIVING SAFETY

#### WARNING

This motorhome has been designed, manufactured and tested with concern for the protection of its occupants. We recommend you perform the following inspections for your safety and the safety of your passengers before starting your vehicle.

1. LP GAS SYSTEM - Turn off at tank for traveling. Test for leaks upon arrival at destination before lighting pilots.
  2. WHEELS - Inspect for damage and check lug nuts for tightness.
  3. TIRES - Inspect for wear and damage and check for recommended air pressure.
  4. LIGHTING - Test for proper operation of all interior and exterior lights including dash lights, headlights, tail lights, brake lights, clearance lights, and turn signals.
  5. EXITS - Inspect release mechanism on emergency exit window, test both locks on main entrance door for ease of operation and instruct passengers how to use both means of exit.
  6. SEAT BELTS - Direct passengers to designated seats, be certain swivel seats are locked into position, and require use of a seat belt. See operator's manual for occupancy and weight restrictions.
  7. APPLIANCES - Turn off and latch or lock doors where provided.
  8. LOOSE PARCELS - Store securely.
  9. UTILITY SUPPLY LINES - Disconnect all electrical, sewer and water lines and secure properly.
  10. ENTRANCE DOOR STEP - Assure step is in retracted position for traveling.
- Read your motorhome and chassis owner's manual for further precautions.



## SECTION 2 – SAFETY AND PRECAUTIONS

- Do not attempt to adjust the driver's seat while the vehicle is moving.
- Do not adjust tilt steering in a moving vehicle.
- Do not operate the cruise control on icy or extremely wet roads, winding roads, in heavy traffic, or in any other traffic situation where a constant speed cannot be maintained.
- Use care when accelerating or decelerating on a slippery surface. Abrupt speed changes can cause skidding and loss of control.
- Never drive the vehicle with a slideout room extended.
- Driving through water deep enough to wet the brakes may affect stopping distance or cause the vehicle to pull to one side. Check brake operation in a safe area to be sure they have not been affected. Never operate any vehicle if a difference in braking efficiency is noticeable.
- Adverse weather conditions and extremes in terrain may affect handling and/or performance of your vehicle. Refer to your chassis manual for complete and related information on driving your vehicle.

---

---

### FUEL AND PROPANE GAS



#### DANGER

All pilot lights, appliances, and their ignitors (see operating instructions) shall be turned off before refueling of motor fuel tanks and/or propane containers. Can cause ignition of flammable vapors, which can lead to a fire or explosion and result in death or serious injury.



#### WARNING

Propane gas containers, gasoline, or other flammable liquids shall not be placed or stored onboard the vehicle because a fire or explosion may result. Propane gas containers are equipped with safety valves, which relieve excessive pressure by discharging gas to the atmosphere. Failure to comply could result in death or serious injury.

- All pilot lights must be extinguished and appliances turned off while refilling the fuel tank or propane gas tank.
- Never smoke while refilling vehicle fuel tank or propane gas tank.
- Never use an open flame to test for propane gas leaks. Replace all protective covers and caps on propane system after filling. Make sure valve is closed and the door is latched securely.
- Never connect natural gas to the propane gas system.
- When lighting range burners, **do not** turn burner controls to "On" and allow gas to escape before lighting match.
- Portable fuel-burning equipment, including wood and charcoal grills and stoves shall not be used inside the recreational vehicle. The use of this equipment inside the recreational vehicle may cause fires or asphyxiation.
- Propane gas regulators must always be installed with the diaphragm vent facing downward. Regulators are equipped with a protective cover. Make sure that the regulator vent faces downward and that the cover is kept in place to minimize vent blockage, which could result in excessive gas pressure causing fire or explosion.
- The following warning label is located in the cooking area to remind you to provide an adequate supply of fresh air for combustion.





**! DANGER**

Do not use gas cooking appliances for comfort heating. Can lead to carbon monoxide poisoning, which can lead to death or serious injury.

**! WARNING**

Gas cooking appliances need fresh air for safe operation.  
Before operating:  
Open vents or windows slightly or turn on exhaust fan prior to using cooking appliance. Gas flames consume oxygen, which should be replaced to ensure proper combustion. Improper use can result in death or serious injury.

Unlike homes, the amount of oxygen supply is limited due to the size of the recreational vehicle, and proper ventilation when using the cooking appliance(s) avoids dangers of asphyxiation. It is especially important that cooking appliances not be used for comfort heating, as the danger of asphyxiation is greater when the appliance is used for long periods of time. Failure to comply could result in death or serious injury.

---

---

## PROPANE GAS LEAKS

Check propane gas system for leaks yearly, or as necessary.

The following label is located in the vehicle near the range area. If you smell gas within the vehicle, quickly and carefully perform the procedures listed.

**! DANGER**

**IF YOU SMELL PROPANE**

1. Extinguish any open flames and all smoking materials.
2. Shut off the propane supply at the container valve(s) or propane supply connection.
3. Do not touch electrical switches.
4. Open doors and other ventilating openings.
5. Leave the area until odor clears.
6. Have the propane system checked and leakage source corrected before using again.

Ignition of flammable vapors could lead to a fire or explosion and result in death or serious injury.

---

---

## PROPANE GAS LEAK DETECTOR

### –If Equipped

Your coach may be equipped with a Propane Gas Leak Detector, similar to the one shown below. The leak detector sounds an alarm if an unsafe amount of propane gas is present inside the coach.



Propane Gas Leak Detector



## SECTION 2 – SAFETY AND PRECAUTIONS

---

### WARNING

**EXPLOSION HAZARD:** DO NOT use an open flame to test for gas leaks. When testing for gas line leaks with a soapy water solution, DO NOT use a detergent containing ammonia or chlorine. These substances may generate a chemical reaction causing corrosion to gas lines, resulting in dangerous leak conditions. Death or serious injury can result.

### Power Connection

The Propane Gas Leak Detector is powered by the house batteries. If the House/Coach Battery Disconnect switch is shut off or the battery cable is disconnected from the batteries, the alarm will not work. The Propane Gas Leak Detector fuse or circuit breaker is located in the 12-volt house electrical load center.

Because the Propane Gas Leak Detector is connected to the house battery, it is always drawing a small amount of current. Even though this current draw is slight, it could drain the house battery during storage periods when the house battery will not be charged regularly by the engine or shoreline.

### Replacement

When replacing this alarm, we recommend replacing only with the same model, or with one that is also listed for RV application. We recommend obtaining a replacement from your Winnebago Industries® dealer.

### Further Information

See the manufacturer's user guide provided in your InfoCase for further instructions.

---

---

## CARBON MONOXIDE WARNING

### WARNING

Avoid inhaling exhaust gases, as they contain carbon monoxide, which is a colorless, odorless, and poisonous gas. Death or serious injury can result.

The best protection against carbon monoxide entry into the vehicle body is a properly maintained engine exhaust and ventilation system. It is recommended that the exhaust system and body be inspected by a qualified motorhome service center:

- Each time the vehicle is serviced for an oil change.
- Whenever a change in the sound of the exhaust system is noticed.
- Whenever the exhaust system, underbody, or rear of the vehicle is damaged.

To allow proper operation of the vehicle's ventilation system, keep front ventilation inlet grill clear of snow, leaves, or other obstructions at all times. **DO NOT OCCUPY A PARKED VEHICLE WITH ENGINE RUNNING FOR AN EXTENDED PERIOD.**

Do not run engine in confined areas, such as a garage, except to move vehicle into or out of the area.

---

---

## CARBON MONOXIDE ALARM

Your coach is equipped with a Carbon Monoxide (CO) Alarm, which has a sensor that is designed to detect toxic carbon monoxide gas fumes resulting from incomplete combustion of fuel. It will detect CO gas from any combustion



source such as the furnace, gas range/oven (if equipped), chassis engine, and electric generator engine.

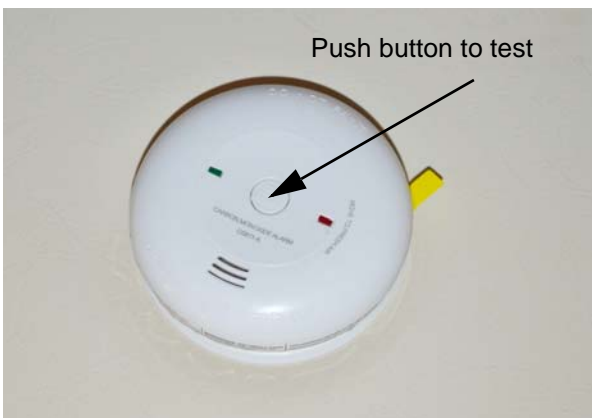

Carbon Monoxide Alarm

 <b>WARNING</b>
Failure to replace this product by the “REPLACE BY DATE” may result in death by Carbon Monoxide poisoning.

### Replacement

When replacing this alarm, we recommend replacing only with the same model, or with one that is also listed for RV application. We recommend obtaining a replacement from your Winnebago Industries® dealer.

### Further Information

Please read the information provided by the manufacturer, which is included in your InfoCase for further information.

## SMOKE ALARM

Your coach is equipped with a Smoke Alarm (located on the ceiling in the lounge area.) The Smoke Alarm is powered by a 9-volt battery and has a sensor that is designed to detect smoke.



Smoke Alarm

The following label is affixed to the Smoke Alarm.

 <b>WARNING</b>
Test smoke alarm operation after vehicle has been in storage, before each trip, and at least once per week during use. Failure to do so can result in death or serious injury.

### Replacement

When replacing this alarm, we recommend replacing only with the same model, or with one that is also listed for RV application. We recommend obtaining a replacement from your Winnebago Industries® dealer.

### Expiration and Further Information

See the manufacturer’s information in your InfoCase for smoke alarm expiration and further instructions.



## SECTION 2 – SAFETY AND PRECAUTIONS

---

---

### FIRE EXTINGUISHER

A dry chemical Fire Extinguisher is located near the entrance door.



Fire Extinguisher  
(Located near entrance door)  
-Typical installation shown

We recommend that you become thoroughly familiar with the operating instructions displayed on the side of the Fire Extinguisher and in the information supplied in your InfoCase.

We also recommend that you inspect the Fire Extinguisher for proper charge at least once a month in accordance with National Fire Protection Association (NFPA) recommendations as stated on the label.

If the charge is insufficient, the Fire Extinguisher must be replaced.

### NOTICE

Do not test the fire extinguisher by discharging it. Partial discharge can cause leakage of pressure or contents, which would render the unit inoperative when needed. When using the fire extinguisher, aim the spray at the base of the fire.

---

---

### Replacement

If for any reason you must replace the Fire Extinguisher, the replacement must be the same type and size as the one originally supplied in your coach. We recommend obtaining a replacement only from your Winnebago Industries® dealer or a reliable RV parts supplier.

---

---

### ELECTRICAL

- Careless handling of electrical components can be fatal. Never touch or use electrical components or appliances while feet are bare, while hands are wet, or while standing in water or on wet ground.
- Improper grounding of the vehicle can cause personal injury. Do not plug the utility power cord into an outlet which is not grounded and do not adapt the plug to connect to a receptacle for which it is not designed.
- Do not attach an extension cord to the utility power cord.
- Do not use any electrical device that has had the ground pin removed.
- Avoid overloading electrical circuits. Replace fuses or circuit breakers with those of the same size and amperage rating only. Never use a higher rated fuse or breaker.
- Use caution when handling or working near electrical storage batteries. Always remove jewelry and wear protective clothing and eye covering. Avoid creating sparks.

---

---

### LOADING

- Store or secure all loose items inside the motorhome before traveling. Possible overlooked items such as canned goods or small appliances on the countertop, cooking pans on the range, or free-standing furniture items can become dangerous projectiles during a sudden stop.
- Be aware of GVWR, GAWR, and individual load limit on each tire or set of duals (See “Loading the Vehicle” in *Section 12 - Miscellaneous*).



- Never load the motorhome in excess of the gross vehicle weight rating or the gross axle weight rating for either axle.

---

---

## MAINTENANCE

- Do not remove the radiator cap while engine and radiator are still hot. Always check coolant level visually at the see-through coolant reservoir.
- Never get beneath a vehicle that is held up by a jack only.
- Do not mix different construction types of tires on the vehicle, such as radial, bias, or belted tires, as vehicle handling may be affected. Replace tires with exact size, type, and load range.
- Refer to the chassis manual for complete maintenance precautions and recommendations.

---

---

## EMERGENCY EXITS

### Escape Window

The escape window is secured by two red safety latches at the bottom or side of the window.

To open, lift both latches up and toward the center of the window, then push outward near the bottom of the window.



Escape Window  
(Lift both red safety latch handles UP  
and push window OUT)  
-Typical View



---

---

## POWER SOFAS AND BEDS



### WARNING

Keep people away from operating mechanism and pinch hazard areas during use. Failure to do so could cause injury.

---

---

## SLIDEOUT ROOMS



### WARNING

Your motorhome may have more than one slideout room. Understand which switch operates which slideout room prior to operation. Make sure all slideout rooms are clear of people who could be harmed or obstacles that could cause damage prior to operating any slideout rooms. Failure to observe can result in death or serious injury.

Check inside and outside the vehicle to make sure that there are no people who could be harmed or obstacles that could cause damage due to room activation.



## SECTION 2 – SAFETY AND PRECAUTIONS

---



### WARNING

Keep all persons clear of the slideout room and moving parts while extending or retracting. Do not occupy the slideout room while it is being extended or retracted. Failure to observe can result in death or serious injury.



### WARNING

This vehicle, like other vehicles, may contain small amounts of one or more substances which are listed by the state of California for causing cancer or reproductive toxicity.

---

## FORMALDEHYDE INFORMATION

Some of the materials used in this recreational vehicle emit formaldehyde. Eye, nose, and throat irritation, headache, nausea, and a variety of asthma-like symptoms, including shortness of breath have been reported as a result of formaldehyde exposure. Reaction to formaldehyde exposure may vary among individuals. Elderly persons and young children, as well as anyone with a history of asthma, allergies, or lung problems may be at greater risk. Research is continuing on the possible long-term effects of exposure to formaldehyde. Inadequate ventilation may allow formaldehyde and other contaminants to accumulate in indoor air. Ventilation to dilute the indoor air may be obtained from a passive or mechanical ventilation system. Always be sure to thoroughly ventilate your recreational vehicle before and during each use. High indoor temperatures and humidity may raise formaldehyde levels. When a recreational vehicle is in areas subject to high temperatures, an air conditioning system can be used to control indoor temperature levels. If you have any questions regarding the health effects of formaldehyde, consult your doctor or local health department.

---

## MOLD, MOISTURE, AND YOUR MOTORHOME

### What is Mold?

Molds are part of the natural environment. They are as old as the Earth itself and mold spores are almost everywhere at some level waiting to grow. Mold plays a part of nature by breaking down dead organic matter, such as fallen leaves and dead trees. Indoors however, mold growth should be avoided. Molds reproduce by means of tiny spores. Those spores are invisible to the naked eye and float throughout the outdoor and indoor air. Because of the nature of the use of a motorhome, it is natural for a motorhome to be introduced into an environment with mold spores.

Mold is a plant and requires its own special environment to grow. That environment includes organic materials, nutrients, moisture, and proper temperature.

### How Can I Avoid Mold?

To reduce the ability for mold to grow, you must reduce what constitutes its growth environment. Mold can grow with the smallest of a nutrient base. Just small amounts of dirt or dust on the carpet can be enough to allow the mold process to begin. Keep the environment as clean as possible. Vacuum the carpet. Clean food spills thoroughly and quickly. Avoid grease buildup near the stove or sink. Clean the exhaust fan above the stove often.

Minimize moisture in your motorhome and keep humidity low. Clean spills quickly. Do not allow condensation to build up. You can open windows and vents to minimize condensation.



Use of the air conditioner can assist in removing moisture from the air. Avoid leaks, but if leaks do occur, make repairs promptly.

Avoid bringing mold into your motorhome. Plants, cloths, books, and other household items may already have mold present. It is easy to transfer mold into your motorhome environment.

Monitor your motorhome. Periodically check those hidden areas in corners, closets, and cabinets to assure mold is not present.

### What if I Find Mold?

If mold develops, clean the area with a concentrate of soap and bleach. Items that contain mold that cannot be cleaned should be removed from the vehicle.

### Can Mold Harm Me?

The effects of mold and airborne mold spores may cause irritation to some people. Experts disagree on the level of exposure that may cause health concerns.

### If Mold Is Present, What Will Winnebago Industries® Do?

If Winnebago Industries determines that mold is present in the motorhome as a result of a manufacturing defect reported to Winnebago Industries within the limited warranty period, Winnebago will clean the affected area(s) and/or replace affected items as it deems necessary. This is the extent of coverage provided by Winnebago Industries. Winnebago Industries, however, will not assume responsibility for mold deemed to be a result of a motorhome users lack of timely and appropriate action to mitigate circumstances should a problem occur.

If Winnebago Industries determines that mold is present due to conditions it determines is not a result of a manufacturing defect found within the warranty period, Winnebago Industries will not provide any financial assistance to the repair of the condition.

---

---

## ROOF

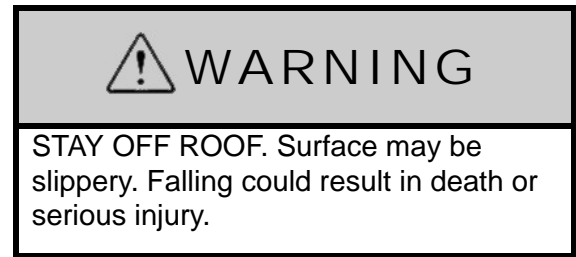

Walking or working on the roof should be left to qualified service personnel using proper safety equipment in a safe environment. You should only walk or work on the roof if you are qualified and have created a safe environment.

For your safety, it is not recommended that you store or carry items on the roof.

---

---

## ROADSIDE EMERGENCY

Because of the size and weight of this vehicle and its tires, and the possible complications involved in tire changing, we strongly advise obtaining professional road service to change a flat tire whenever possible. However, if an emergency requires you to change the tire yourself, please exercise extreme caution and read all tire changing information in the chassis manual.

Never get beneath a vehicle that is held up by a jack only.

### If You Get A Flat Tire

- DO NOT panic.
- Grip the steering wheel firmly and steer the vehicle as straight as possible. Avoid quick maneuvers. You may need to counter-steer to compensate for “pull” created by the failed tire.
- DO NOT stomp on the brake. This abruptly shifts the vehicle’s weight forward, making it nose-dive and pull toward the blown-out side.
- DO NOT jerk your foot off the accelerator. Just ease back on the accelerator slowly and gently to continue momentum. The deflated tire will slow the vehicle.



## SECTION 2 – SAFETY AND PRECAUTIONS

- If you must change lanes to get to a safe stopping place, use your signals to warn other motorists and change lanes smoothly and carefully after you are certain the lane is clear.
- Let the vehicle coast to a stop, gently steering to a safe stopping place off the traffic lanes of the road. Do not worry about damaging the tire or wheel rim by driving on it. A tire or wheel replacement is cheaper than damaging the vehicle or injuring yourself.
- When you have come to a stop, activate your hazard flashers to warn other motorists, then exit the vehicle carefully.
- Set out flares or other warning devices.

Check your tires for proper inflation before each trip and at least once a month with an accurate tire gauge.

### Recovery Towing

When calling a professional towing service, we recommend that you advise them of your coach length and approximate front axle weight listed on your Vehicle Certification Label. This will allow the towing operator to determine the proper towing equipment to use.

Winnebago Industries® does not assume responsibility for damage incurred while towing this vehicle.

*NOTE: Consult your chassis manual for towing instructions or precautions provided by the chassis manufacturer.*

### NOTICE

Do not lift on bumper. Damage will result to front end body parts.

### WARNING

Stay out from beneath the motorhome while it is suspended by the towing assembly. Do not allow passengers to occupy a towed vehicle. Death or serious injury can result.

### JUMP STARTING

If your coach will not start from the chassis battery, try using the Battery Boost switch to divert power from the house batteries to the starter. (See “Battery Boost Switch” in *Section 3 - Driving Your Motorhome*).

If you wish to try jump starting the engine using another vehicle or booster system, see the chassis manual for connecting jumper cables to the automotive electrical system.

### NOTICE

Do not attempt to push start this vehicle. Damage to the transmission or other parts of the vehicle will occur.

### ENGINE OVERHEAT

If you see or hear steam escaping from the engine compartment or have any other reason to suspect an extreme engine overheating condition, pull the vehicle over to the roadside as soon as it is safe to do so, stop the engine, and get all passengers out of the vehicle.

### NOTICE

Operating a vehicle under a severe overheating condition can result in damage to the vehicle.





For information on what to do in case of overheating, consult the chassis manual.



## SECTION 3 – DRIVING YOUR MOTORHOME

The information in this section refers only to features installed or adapted to the dash and driver compartment area by Winnebago Industries®. It also includes passenger seating in the living area of the coach.

### Further Information

See the chassis manual in your InfoCase for all original chassis related controls, instrumentation, switches, and other features. This includes items such as transmission, parking brakes, cruise control, gauges, wipers, lights, etc.

---

---

## SEATS – DRIVER/CO-PILOT

The driver and co-pilot seats may be independently adjusted to suit individual preference.

The seats may be swiveled to provide easy entrance and exit. The swivel feature also allows the seats to be turned toward the living area for additional seating while the vehicle is parked.

 <b>WARNING</b>
Assure seat is in its forward and locked position for travel. Do not adjust seat while vehicle is in motion. Failure to comply may result in injuries.

### Multi-Adjustable Power Seats

Your coach is featured with multi-adjustable power seats for your travel convenience. The power seat controls are located on the lower aisle (inboard) side of the seat base.

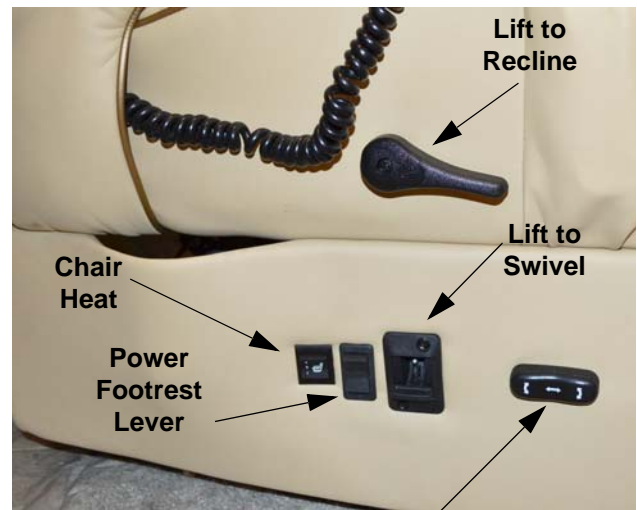

#### 6-way Switch

- Front of Seat Up/Down
- Forward/Back
- Back of Seat Up/Down

### To Face Driver's Seat Rearward

- Tilt the steering wheel all the way up and put the left armrest down.
- Move the seat rearward fully and then ahead a few inches.
- Swivel the seat to the right until it just contacts the steering wheel, then move the seat ahead all the way to clear the steering wheel.
- Swivel the seat the rest of the way to face the living area.
- Position the tilt wheel down and to provide maximum clearance to recline the seat.
- Reverse the procedure to face the seat forward.

### Armrest Adjustment

The armrests may be swung upward out of the way for easy exit or access to the front seats. A roller on the underside at the rear of the armrest also lets you adjust the resting angle for personal comfort, whether the seat is upright or reclined.

## SECTION 3 – DRIVING YOUR MOTORHOME

*NOTE: Your comfort adjustment is retained when the armrest is folded upright to exit seat. When you return to your seat and fold the armrest forward, it will stop at the previously selected position.*



### Heated Seats

The driver and co-pilot seats are heated for your personal comfort. Chair Heat switches are located on the inboard side of the driver and co-pilot seats.

- **High Heat Setting** - For maximum heat output, press the Chair Heat switch UP.
- **Low Heat Setting** - For lower heat output, press the Chair Heat switch DOWN.
- When the Chair Heat switch is in the middle position, the heater is OFF.

The heated seat control module is programmed to automatically shut off after 30 minutes of operation.

*NOTE: The heated seats are only operable when the ignition key is turned ON.*

### Power Footrest with Power Extension

The driver and co-pilot seats are equipped with a power footrest that provides greater utility to be used as a lounge chair when rotated for television viewing or as part of a lounge conversational area. The footrest lever is located on the inboard side of the driver and co-pilot seats.

- To extend footrest, lift black footrest lever.
- To retract footrest, push downward on black footrest lever.

### Massage

The Massage Remote Control is conveniently located on the inboard side of the driver and co-pilot seats.



Cab Seat Massage Remote Control  
(Located on inboard side of driver and co-pilot seats)

- **PWR** - This unit has a 15 minute timer that is activated by pressing “PWR.” It may also be turned on by pressing any ZONE (1-3).
- **ZONE 1** - Upper back massage.
- **ZONE 2** - Lower back massage.
- **ZONE 3** - Thigh region massage.
- **SELECT** - Allows you to chose any or all zones for massage.
- **PULSE** - Massage motors turn ON and OFF to simulate a pulsing action.
- **WAVE** - Massage motors move up and down in a wave-like action.
- **ZIG ZAG** - Alternating wave massage.
- **INTENSITY** - Increase or decrease the intensity of massage pulse in any function.
- **SPEED** - Increase or decrease the rate at which the massage action travels.

**Further Information**

Refer to the manufacturer’s user guide provided in your InfoCase for complete operating instructions and safety precautions.

**Power Lumbar**

Adjust lumbar tension on your cab seats to best suit your comfort needs. The Power Lumbar switches are located on the outboard side of the driver and co-pilot seats.

- Press and Hold the Power Lumbar switch in the up position to increase lumbar tension.
- Press and Hold the Power Lumbar switch in the downward position to decrease lumbar tension.



Power Lumbar Switch  
(Located on outboard side of seat)  
-Typical View

seat mechanism. After any serious accident, any seat belts which were in use at the time must be inspected and replaced if necessary.



**Adjustment**

To lengthen belt, swivel the tab end at a right angle to belt and pull strap to desired length. To shorten, pull loose end of belt.

**To Fasten**

Be sure belt is not twisted. Grasp each part of the belt assembly and push tongue into buckle. Adjust to a snug fit by pulling the loose end away from the tongue.

**To Release**

Press button in center of buckle and slide tongue out of buckle.

---

---

**SEAT BELTS**

Seats intended for occupancy while the vehicle is in motion are equipped with seat belts for the protection of the driver and passengers.

**Lap Belts**

The lap belts must be worn as low as possible and fit snugly across the hip area. Always sit erect and well back into the seat. To gain full protection of the safety belt, never let more than one person use the same safety belt at any one time, and do not let the safety belts become damaged by pinching them in the doors or in the

 <b>WARNING</b>
Snug and low belt positions are essential. This will ensure that the force exerted by the lap belt in a collision is spread over the strong hip area and not across the abdomen, which could result in serious injury. Only seats equipped with seat belts are to be occupied while vehicle is in motion. Swivel seats must be in the locked, forward facing position while vehicle is in motion.

## SECTION 3 – DRIVING YOUR MOTORHOME

### Lap/Shoulder Belts

#### Fastening

Hold the belt just behind the tongue. Next, bring the belt across the body and insert the tongue into the buckle until the latch engages.

#### Unfastening

Press the release button in the buckle. Hold onto the tongue when you release it from the buckle to keep it from retracting too rapidly.

When the lap-shoulder belt is in use, the lap belt must ride low across the hip area and the shoulder belt must ride diagonally over the shoulder toward the buckle.

The shoulder belt is designed to lock only during a sudden stop, sudden body movement, or a collision. At all other times it will move freely with the occupant.



### WARNING

Never wear the shoulder belt in any position other than as stated above. Failure to do so could increase the chance or extent of injury in a collision.

### Seat Belt Care and Cleaning

- Be careful not to damage the belt webbing and hardware. Take care not to pinch them in the seat or doors.
- Inspect the belts and hardware periodically. Check for cuts, frays, and loose parts. Damaged parts should be replaced. Do not remove or modify the belt system.
- Keep belts clean and dry. If the belts need cleaning, use only a mild soap and water solution. Do not use hot water. Do not use abrasive cleaners, bleach, or dyes. These products may weaken the belts.
- Replace any belt assembly that was used during a severe impact. Replace the complete assembly even if damage is not apparent.

### KEYONE™ LOCK SYSTEM

#### -If Equipped

Your coach is equipped with the KeyOne lock system. A single key will open every door lock in the entire vehicle and ignition (except the security deadbolt lock on the entrance door).

The key number for your coach is registered in our factory database, so if you ever lose your keys, any Winnebago Industries® dealership can order a new key for you.

### POWER DOOR LOCKS

The power door lock switches that control the main entrance door and compartment doors are conveniently located throughout your coach.

There are three different switches, All Doors, Entry Door, and Bay Doors. All doors will lock and unlock both the entry door and compartment (bay) doors. Entry door and Bay doors only lock and unlock their respective doors.



Power Door Locks - All Doors  
-Typical View

\*Bedroom switch panel shown

*The switch will illuminate blue when the switch is on. White illumination indicates the switch is off.*



Entry Door

Compartment  
(Bay) Doors

Power Door Locks - Entry Door and  
Compartment (Bay) Doors  
-Typical View

*\*Entry door switch panel shown  
The switch will illuminate blue when the  
switch is on. White illumination indicates the  
switch is off.*



Power Door Locks - Entry Door  
(Located on dash)  
-Typical View

## Keyless Entry System

Your motorhome is equipped with a Keyless Entry System that will permit keyless locking and unlocking of your coach and cargo doors by using the key ring remote or keypad (located on assist handle).

## Remote with Cargo Lock Feature



Keyless Entry Remote  
-Typical View

## Assist Handle with Keypad

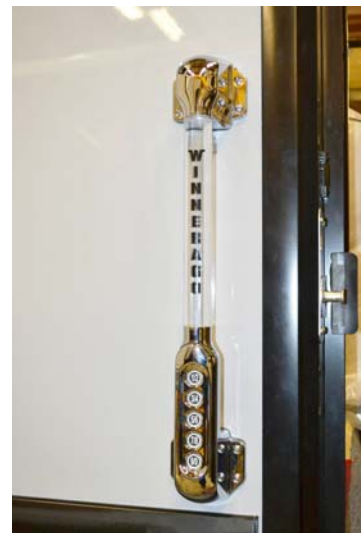

Assist Handle Keypad  
-Typical View

## Reprogramming Remote

When replacing batteries, the remote unit may need to be reprogrammed with a push button on the keyless entry system control box.

The keyless entry control box is located in the passenger side trim panel (remove magazine rack to access). Open carefully to avoid damage or disconnection of wiring looms.

## SECTION 3 – DRIVING YOUR MOTORHOME

### Further Information

Refer to the Keyless Entry System information provided in your InfoCase for complete operating information as well as a full description of all of the system's features and programming instructions.

---

---

### ACCENT LED LIGHT STRIPS (FRONT)

The front of your coach is equipped with Accent LED Light Strips.

Your coach is equipped with one of the following front end designs.



Accent LED Light Strips  
-Typical View



Accent LED Light Strips  
-Typical View

The Front AUX switch (located on the dash) operates the LED Light Strips.

Press Front AUX switch UP to turn ON. Press Front AUX switch DOWN to turn OFF.



Front AUX Switch  
(Located on dash)  
-Typical View

---

---

### COLLISION AVOIDANCE SYSTEM

#### -If Equipped

The collision avoidance system alerts the driver of certain potentially dangerous situations. The collision avoidance system includes a single smart camera mounted to the windshield and a 2" round display monitor mounted to the upper dash area. Your system may feature the following:

- **Vehicle and Motorcycle Forward Collision Warning** - Displays only when a vehicle in the same lane is detected.
- **Lane Departure Warning** - Active above 34 MPH and if turn signals are not used when changing lanes.
- **Headway (Following Time) Monitoring and Warning** - Active above 19 MPH.
- **Pedestrian and Bicycle Collision Warning** - Active under 31 MPH.
- **Speed Limit Indication** - Active at any speed. Notifies the driver if the vehicle exceeds the allowed speed limit detected on speed signs.



 **WARNING**

The Collision Avoidance System is not a substitute for Safe and Alert driving. Do not attempt to change settings on the Collision Avoidance System while driving.

### Further Information

See the collision avoidance system manual in your InfoCase for complete features, operating instructions, and safety precautions.

---

---

## MIRRORS – POWER ELECTRIC

Always adjust mirrors for maximum rear visibility before driving. Make sure the seat is adjusted for proper vehicle control and that you are sitting back squarely into the seat.



### Mirror Adjustment Control

The mirror control is mounted along sidewall below driver side window. The ignition key must be on to adjust the mirrors.

Move Selector Switch L or R to select mirror. Center “neutral” position disables arrows to avoid unintentionally moving a mirror.

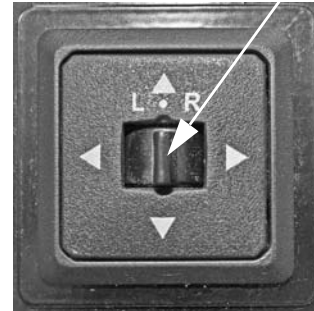

Press Arrow Buttons to move mirror surface in direction indicated.

### Mirror Heaters

The mirrors also contain heating elements to defog or de-ice the mirror glass during cold weather operation. An ON-OFF switch for the mirror heaters is located on the driver side trim panel.

- ON - To turn mirror heat on, press the Mirror Heat switch UP.
- OFF - To turn mirror heat off, press the Mirror Heat switch DOWN.



Mirror Heater Switch  
(Located on dash)  
-Typical View

## SECTION 3 – DRIVING YOUR MOTORHOME

### Sideview Camera

The sideview cameras (built into the driver and passenger side mirrors) activate with the corresponding turn signals and replace the rear camera view on the monitor until the turn is completed or the signal lever is canceled manually.

- Sideview Camera



### 12-Volt Front Drop-Down Solar/Night Shade Switches

(Located on driver side trim panel)

-Typical View

*The switch will illuminate blue when the switch is on. White illumination indicates the switch is off.*

### Turn Signal Indicator Lights

A turn signal indicator is built into the lower section of the driver and passenger side mirrors. The indicators are activated with the corresponding turn signals and will remain activated until the turn is completed or the signal lever is canceled manually.

### Further Information

See the manufacturer's user guide provided in your InfoCase for complete features and operating instructions.

---

---

### FRONT DROP-DOWN SOLAR/ NIGHT SHADE (12-VOLT)

Your coach is equipped with a 12V Front Drop-Down Solar/Night Shade that provides privacy and solar heat protection as well as a sunvisor feature.

The power switches for the 12V Front Drop-Down Solar/Night Shade are located on the driver side trim panel.

Press and Hold the W/S DAY (black) or the W/S NIGHT (white) switch up or down to adjust the shade to the setting that best suits your needs.

A quick press and release of the up or down button will fully extend or retract the shade. Press either button again to stop at desired level.

Dual range motors provide lowering of either two shades to visor height restriction when the ignition is ON and lowers completely to cover the entire windshield when the ignition is OFF.

The Chassis Battery Disconnect switch must be ON to supply power to the solar/night shade.

*NOTE: If power is gradually drained and falls below the lower limit of 11-volts, the motors may lose their electronic set limits and will require reprogramming once normal power has been restored. Refer to the Solar/Night Shade manufacturer's information provided in your InfoCase.*

## Automatic Safety Retraction

The Solar/Night Shade in your vehicle is equipped with an Automatic Safety Retraction feature, which will retract the Solar/Night Shade to the full upper position in the rare event of an internal motor failure.

Should the Automatic Safety Retraction feature deploy, go to your nearest Winnebago Industries® dealer for service before operating the shade again.

*NOTE: Do not attempt to extend the Solar/Night Shade or operate the power switches after deployment.*

## Further Information

Refer to the manufacturer's user guide provided in your InfoCase for complete operating instructions, troubleshooting tips, and maintenance care.

---



---

## INFOTAINMENT CENTER/GPS –If Equipped

The Infotainment Center in your coach is an all-in-one system that offers dash radio, rearview monitor, and GPS capability for your travel convenience.

This system also features SiriusXM® satellite radio, iPod, Bluetooth, and USB connection.

Your radio may be equipped with a Tire Pressure Monitoring System (TPMS).

*NOTE: As a safety feature, this system will not play video's unless the Parking Brake is set.*

## Basic Operating Instructions

Refer to the manufacturer's owner manual and/or quick start guide provided in your InfoCase for a complete explanation of features and operating/set-up instructions.



1. **Bluetooth Microphone**
2. **LDR** - used for dimming the display and **IR Receiver** - used with remote control operations
3. **MENU** - press to go to Main Menu.
4. **NAVI** - press to go to the navigation system.
5. **CAM** - press to switch to camera view.
6. **FAV** - press to directly access favorite audio source.
7. **Rotary Button:**  
**Power** - turn the ignition key to power up the infotainment center.  
**Volume** - turn the rotary button left/right to adjust volume.  
**Mute** - press rotary button to mute.



- Power ON/OFF
- Source
- Dim
- Navigation
- Camera
- Adjust screen display with Set and Arrows

Secondary Monitor  
(Located on dash)  
-Typical View

## Rearview Monitor

The rearview monitor feature of this system lets you see what is directly behind your coach for safety and maneuvering assistance. Sideview cameras also allow you to see what is beside you before turning or changing lanes.

## SECTION 3 – DRIVING YOUR MOTORHOME

---

The radio monitor automatically changes to camera mode when transmission is shifted into reverse. A microphone built into the rear camera lets you hear warning sounds or verbal directions from an assistant.

### Sideview Cameras

The sideview cameras (built into the driver and passenger side mirrors) activate with the corresponding turn signals and replace the rear camera view on the monitor until the turn is completed or the signal lever is canceled manually.

### Tire Pressure Monitoring System (TPMS)

#### –If Equipped

Your coach may be equipped with a tire pressure monitoring system that reports real-time tire-pressure information to the driver.

See the manufacturer’s information provided in your InfoCase for programming and operating instructions.

### Satellite Radio

Your coach is equipped with a SiriusXM® satellite radio receiver that plays through your dash radio.

See the manufacturer’s information provided in your InfoCase for programming and operating instructions.

### GPS

The GPS navigation system can help you confidently chart your course through the most dense concrete jungle or remote country backroad using global satellite positioning technology.

*NOTE: Ensure GPS SD card is inserted in the slot on the dash radio core unit.*

Navigational information can be displayed on both the GPS and radio monitors using either the radio or the remote control.

*NOTE: Ensure the Input Button on the GPS Display Panel is set to VIDEO 1 and the “Aux Zone” on the radio is set to NAV.*

### HDMI

Your coach is equipped with an HDMI connection that plays through your dash radio.

See the manufacturer’s information provided in your InfoCase for operating instructions.

GPS (Navigation)  
SD Card Reader

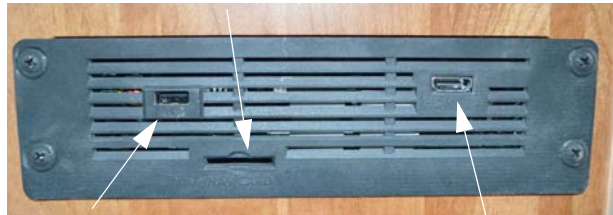

USB  
Port

HDMI  
In

GPS, USB port, and HDMI IN  
(Located on lower dash)  
-Typical View

### USB Port

One (1) USB port (located on the lower dash) is connected to play through your dash radio.

One (1) USB port (located on the upper dash), allows you to charge your device only. The device will not play through your dash radio from this location.

### Bluetooth

Your coach is equipped with a Bluetooth microphone built into the radio system for hands-free cell phone usage.

See the manufacturer’s information provided in your InfoCase for programming and operating instructions.

### iPod Connection

Your coach may be equipped with an iPod Connection to play your iPod through the dash radio. Plug your iPod cable into the USB port on the face of the dash radio core unit (located on the lower dash).

## Radio Remote Controls

A steering wheel mounted remote control for the radio lets you change radio stations or CD selections without taking your eyes off the road or hands off the wheel.



CAT+/CAT-  
Up/Down

Frequency  
Up/Down

Steering Wheel Radio Paddles

An additional hand-held remote allows these same conveniences for the passenger. The hand-held radio remote is included in your InfoCase.

## Radio Power Switch

The Radio Power switch lets you connect the dash radio to the coach batteries with the ignition switch turned off for listening while parked. This prevents accidental draining of the chassis battery with prolonged use of the radio.

*NOTE: The House/Coach Battery Disconnect switch must be ON while listening to the dash radio because the audio relay is powered by house batteries. If the House/Coach Battery Disconnect switch is OFF, the speakers will not emit sound.*



Radio Power Switch  
(Located on dash)  
-Typical View

- Press HOUSE to listen to the radio while parked without the ignition key on.
- Press ENGINE ("ENG") to listen while driving.

## Further Information

See the manufacturer's user guide provided in your InfoCase for complete operating instructions.

---

---

## INFOTAINMENT CENTER/GPS -If Equipped

The Infotainment Center in your coach is an all-in-one system that offers dash radio, rearview monitor, and GPS capability for your travel convenience.

This system also features SiriusXM<sup>®</sup> satellite radio, iPod, Bluetooth, and USB connection.

*NOTE: As a safety feature, this system will not play video's unless the Parking Brake is set.*

## Basic Operating Instructions

Refer to the manufacturer's owner manual and/or quick start guide provided in your InfoCase for a complete explanation of features and operating/set-up instructions.

## SECTION 3 – DRIVING YOUR MOTORHOME



- **Bluetooth Microphone**
- **Power** - press to turn On/Off
- **Menu** - press to go to Main Menu.
- **Dim** - press to adjust brightness of LCD.
- **Volume** - press to adjust volume UP (+) or DOWN (-).
- **Navigation**
- **Favorites** - press to directly access favorite audio source.
- **Mute** - press to mute all audio including navigation prompts.
- **IR Receiver**



- Power ON/OFF
- Source
- Dim
- Navigation
- Camera
- Adjust screen display with Set and Arrows

Secondary Monitor  
(Located on dash)  
-Typical View

### Rearview Monitor

The rearview monitor feature of this system lets you see what is directly behind your coach for safety and maneuvering assistance. Sideview cameras also allow you to see what is beside you before turning or changing lanes.

The radio monitor automatically changes to camera mode when transmission is shifted into reverse. A microphone built into the rear camera lets you hear warning sounds or verbal directions from an assistant.

### Sideview Cameras

The sideview cameras (built into the driver and passenger side mirrors) activate with the corresponding turn signals and replace the rear camera view on the monitor until the turn is completed or the signal lever is canceled manually.

### Satellite Radio

Your coach is equipped with a SiriusXM® satellite radio receiver that plays through your dash radio.

See the manufacturer's information provided in your InfoCase for programming and operating instructions.

### GPS

The GPS navigation system can help you confidently chart your course through the most dense concrete jungle or remote country backroad using global satellite positioning technology.

*NOTE: Ensure GPS SD card is inserted in the slot on the dash radio core unit.*

Navigational information can be displayed on both the GPS and radio monitors using either the radio or the remote control.

*NOTE: Ensure the Input Button on the GPS Display Panel is set to VIDEO 1 and the "Aux Zone" on the radio is set to NAV.*

### HDMI

Your coach is equipped with an HDMI connection that plays through your dash radio.

See the manufacturer's information provided in your InfoCase for operating instructions.

GPS (Navigation)  
SD Card Reader

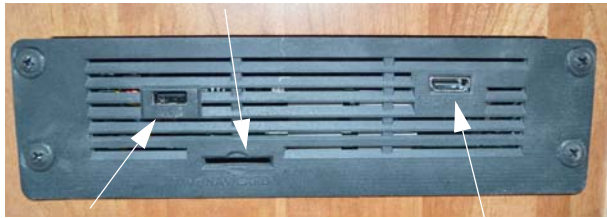

USB  
Port

HDMI  
In

GPS, USB port, and HDMI IN  
(Located on lower dash)  
-Typical View

### USB Port

One (1) USB port (located on the lower dash) is connected to play through your dash radio.

One (1) USB port (located on the upper dash), allows you to charge your device only. The device will not play through your dash radio from this location.

### Bluetooth

Your coach is equipped with a Bluetooth microphone built into the radio system for hands-free cell phone usage.

See the manufacturer's information provided in your InfoCase for programming and operating instructions.

### iPod Connection

Your coach may be equipped with an iPod Connection to play your iPod through the dash radio. Plug your iPod cable into the USB port on the face of the dash radio core unit (located on the lower dash).

### Radio Remote Controls

Your coach is equipped with either a switch pad (located below the horn pad) or paddles (located on right and left side switch panels).

A steering wheel mounted remote control for the radio lets you change radio stations or CD selections without taking your eyes off the road or hands off the wheel.



Steering Wheel Radio Switch Pad

Power/Mute

Volume  
Up/Down



CAT+/CAT-  
Up/Down

Frequency  
Up/Down

Steering Wheel Radio Paddles

An additional hand-held remote allows these same conveniences for the passenger. The hand-held radio remote is included in your InfoCase.

### Radio Power Switch

The Radio Power switch lets you connect the dash radio to the coach batteries with the ignition switch turned off for listening while parked. This prevents accidental draining of the chassis battery with prolonged use of the radio.

*NOTE: The House/Coach Battery Disconnect switch must be ON while listening to the dash radio because the audio relay is powered by house batteries. If the House/Coach Battery Disconnect switch is OFF, the speakers will not emit sound.*

## SECTION 3 – DRIVING YOUR MOTORHOME

---



Radio Power Switch  
(Located on dash)  
-Typical View

- Press HOUSE to listen to the radio while parked without the ignition key on.
- Press ENGINE (“ENG”) to listen while driving.

### Further Information

See the manufacturer’s user guide provided in your InfoCase for complete operating instructions.

---

### CB RADIO POWER WIRING

Your coach is pre-wired for CB radio power connection. The wires are located beneath the dash to the left of the steering wheel.

Look for a pair of wires - yellow (+) and white (-) with connectors and flag labels suspended from the wiring harness.



CB Power Wires  
-Typical View

---

### PARKING BRAKE Freightliner® Chassis



Parking Brake Knob  
-Typical View

- Pull to apply
- Push in to release

Use the parking brake knob to apply the park brake whenever the vehicle is parked.

Never try to drive the vehicle with the parking brake applied. This can cause excessive wear on the brakes and may damage the transmission.

*NOTE: It is normal to hear an occasional burst of air pressure from the rear of the vehicle. This is an automatic moisture purging feature of the air brake system. See the Brakes section of your chassis manual for instructions on periodic draining of brake air tank.*

---

### ENGINE BRAKE SYSTEM Freightliner® Chassis

Many large diesel trucks are equipped with a compression release engine brake system, commonly referred to as a “jake brake”– so named for Jacobs Vehicle Systems™, the originator of this type of braking system.

The engine brake is a device mounted on top of the diesel engine that temporarily changes the timing of the exhaust valves, momentarily shutting down either three cylinders or all six cylinders, depending on Low, Medium, or High setting. This turns the power-producing diesel engine into a power-absorbing compressor, which provides effective deceleration of the



vehicle. Combined with use of the chassis air brakes, the engine brake delivers a substantial degree of braking power.

The engine brake activation switch is located on the driver side trim panel. Press and release the ON side of the switch to activate the engine brake system. The engine brake will operate whenever you let up on the throttle pedal while the switch is ON.



Engine Brake Activation Switches  
(Located on driver side trim panel)  
-Typical View

 <b>WARNING</b>
Do not use the exhaust brake if road surfaces are slippery. Using the exhaust brake on wet, icy, or snow-covered roads could result in loss of vehicle control, possibly causing personal injury or death, or property damage.

### Further Information

See your chassis manual in your InfoCase for more instructions, information, and precautions on using this feature.

---

---

## TAG AXLE SUSPENSION SYSTEM

### Freightliner® Chassis

Your coach may be equipped with a Tag Axle Suspension System, which is designed to increase the Gross Vehicle Weight Rating (GVWR). This system is to be used when the rear suspension/axle will be loaded to a weight greater than 23,000 lbs. When certain conditions arise, air can be exhausted from the air springs to improve maneuverability or traction on the rear axle by operating the Tag Axle switch (located on the driver side trim panel).



Tag Axle Switch  
(Located on the driver side trim panel)  
-Typical View

### Tag Axle Switch Operation

#### Tag Dump Position

This mode is activated when the following conditions are met.

- The tag-axle suspension dump switch is momentarily pressed to toggle the tag-axle control module into the dump mode.
- The vehicle speed is less than 8 mph.
- The vehicle is in neutral or forward gear.

*NOTE: If the vehicle exceeds a speed of 8 mph while the switch is in the Tag Dump position, the tag-axle suspension dump*

## SECTION 3 – DRIVING YOUR MOTORHOME

---

*switch control system will override the Tag Dump mode and the tag suspension air bags will refill.*

### Auto Dump Position

- This mode is activated automatically when in reverse gear, when the Tag Axle switch is in the MIDDLE position. The Auto Dump feature gives you better maneuverability while driving in reverse.

### Off Position

- The Tag Dump mode is inactive when the Tag Axle switch is in the OFF position.

*NOTE: If an override event occurs while the switch is held in the Tag Dump position, the switch must be cycled on and off to clear the override command.*

### Further Information

See the chassis manual provided in your InfoCase for more information and precautions on using this feature.

---

---

## HEADLIGHT SWITCH

The headlight switches are located on the left side of the dash.

- **Fog Lights:** press the switch UP.



- **ALL Lights ON:** press the switch UP.
- **Parking Lights ON:** press the switch to the middle position.
- **ALL lights OFF:** press the switch DOWN.
- **Bright:** press the switch UP.
- **Dim:** press the switch DOWN.

Headlight Switches  
(Located on left side of dash)  
-Typical View

### Further Information

Refer to the chassis manual provided in your InfoCase for additional information on the Headlight switch.

---

---

## HAZARD WARNING FLASHERS

The hazard warning flashers provide additional safety when the vehicle must be stopped on the side of the roadway and presents a possible hazard to other motorists. When the flashers are on, it serves as a warning to other drivers.



**Hazard Warning Flashers**  
(Typical View - your coach may differ depending on model)

- Pull Silver Lever outward to activate Hazard Flashers.

*NOTE: Move multi-function lever up or down to cancel.*

### **Further Information**

See the chassis manual in your InfoCase for instructions on activating, operating, and canceling hazard warning flashers.

---

---

### **SIGNAL LEVER/HEADLIGHT HIGH-LOW BEAM**

The signal lever controls the turn signals and headlight high/low beams.



**Turn Signals/High-Low Beams**  
(Typical View - your coach may differ depending on model)

- Move multi-function lever upward for right turn signal and downward for left turn signal. An audible chime will alert you when the signals are flashing.
- Pull end of handle toward you to switch headlight high/low beams.

### **Further Information**

See your chassis manual for further operating instructions and features.

## SECTION 3 – DRIVING YOUR MOTORHOME

### STEERING COLUMN ADJUSTMENT

The tilt/telescope adjustment pedal is located on the floor to the left of the steering column as shown.



Press pedal down to adjust steering wheel tilt or telescope

### Adjust Steering Wheel or Column

Press the pedal down to adjust either the tilt or telescope. Release the pedal when you have adjusted the tilt angle or steering wheel distance to your preferred position.



#### WARNING

Do not adjust the steering column or tilt wheel while the vehicle is in motion. Doing so may cause loss of vehicle control resulting in death or personal injury.

### BRAKE/ACCELERATOR PEDALS – ADJUSTABLE

#### (Brake/Accelerator Pedals)

Your coach is featured with adjustable brake/accelerator pedals for your driving convenience.

#### Adjusting Pedals

- Press the Pedal switch UP (FWD) to move pedals forward.
- Press the Pedal switch DOWN (RWD) to move pedals rearward.



Adjustable Pedal Switch  
(Located on dash)  
-Typical View



#### WARNING

Do not adjust the brake/accelerator pedals while the vehicle is in motion. Doing so may cause loss of vehicle control resulting in death or personal injury.

#### Further Information

See the chassis manual provided in your InfoCase for further information on this feature.

---

---

## SMARTWHEEL™ STEERING WHEEL CONTROL SYSTEM

### –If Equipped

The steering wheel control system offers convenient and safe control of the horn, headlight, marker light flash, cruise control, and wiper functions all from switch panels mounted at your fingertips on the steering wheel.

Your coach is equipped with one of the following steering wheels.

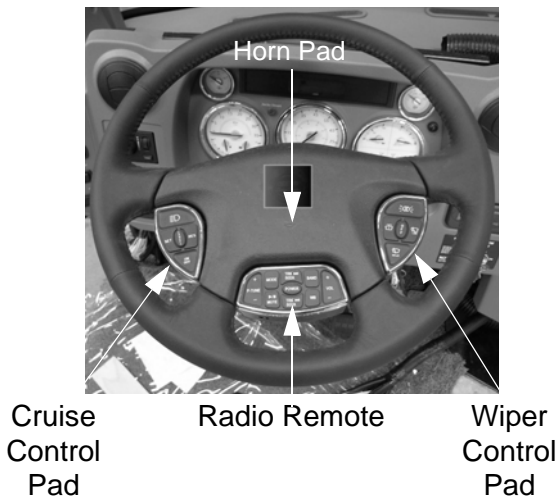

-Typical View

Refer to "Infotainment Center/GPS" in this section for instructions on operating the radio control paddles.

### Horn Pad

- Normally sounds the chassis horn.
- Also sounds air horns if Air Horn switch on dash is activated.

### Headlight Courtesy Flash



- Press and release to blink or flash the headlights.
- Night: If the headlights are already turned on, pressing the switch will blink them off briefly.
- Day: If the headlights are off, pressing the switch will flash them on briefly.

*NOTE: Truckers often use this signal to indicate to a passing rig when it is clear to pull back into the lane ahead of them.*

### Marker Light Courtesy Flash



- Press and release to blink or flash the marker (clearance) lights.
- Night: If the marker lights are already turned on, pressing the switch will blink them off briefly.
- Day: If the marker lights are off, pressing the switch will flash them on briefly.

*NOTE: Truckers often use this signal as a greeting or an expression of thanks for assistance in passing, etc.*

## SECTION 3 – DRIVING YOUR MOTORHOME

### Cruise Control Functions



#### On/Off (Cruise System On/Off)

- Press to turn cruise control system on or off.
- This will also erase previously set speed.

#### Set (Set Speed/Coast)

- Press to maintain current desired driving speed. Will not work below 40 mph.
- This button will also perform “Coast” feature. Press and hold until vehicle slows to desired speed and release to establish new “set” speed.

#### Res (Resume/Accel)

- Press to return to previous “set” speed after braking or reducing speed.

#### Cancel

- Press to switch cruise function off without losing current “set” speed.



### WARNING

Do not operate the cruise control on icy or extremely wet roads, winding roads, in heavy traffic, or in any other traffic situation where a constant speed cannot be maintained.

### Wiper Functions



There are four wiper control buttons:

- Wiper On - HI/LO
- Wiper Off
- Wiper Delay
- Wash/Wipe

*NOTE: Many states now have laws that require headlights to be on during precipitation conditions. To assure compliance with this law, the headlights will come on whenever you press any of the wiper function buttons - Hi/Lo, Wash, or Delay. Headlights will turn off when the ignition switch is turned off.*

#### Wiper On - Hi/Lo

- Press to turn wipers on at Lo speed;
- Then press again to switch wiper speed back and forth from Lo to Hi speed.
- Press Off button to switch wipers off.

#### Wiper Off

- Press to shut wipers off.
- Wipers will also switch off when the ignition is turned off.

#### Wiper Delay

This switch will set a Lo speed wiper delay time based on the duration between any two presses of the button.

**How it works:**

- During a light rain or mist, when your windshield needs a clearing wipe, press the button once and the wiper will swipe back and forth once at Lo speed. Let's say 7 seconds later, the windshield needs another wipe - press the button again and the delay time will be set to 7 seconds.
- If the mist gets heavier and you press the button again 3 seconds after the last wipe, the delay time will be reset to 3 seconds.
- The delay time can be set from approximately 1 to 30 seconds.

**Wash/Wipe**

- Press switch to activate Lo wipers and spray washer fluid onto the windshield for as long as you hold the button.
- After you release the button, the wipers will continue for three wipe cycles, then turn off.
- If wipers are already active, pressing the switch will simply spray fluid onto the windshield without affecting wiper setting.

**Idle Speed Control**

The cruise control system can also be used to control diesel engine idle speed (rpm) while parked.

**High Idle**

- Shift the transmission into Neutral (N).
- On the turn signal lever, move the slide switch to the ON position or press the ON button on the steering wheel. Accelerate to the desired rpm. Press and release the SET/COAST or SET/COAST button on the steering wheel.
- Disengage by stepping on the brake pedal, by moving the ON/OFF switch to the OFF position, or by pressing the OFF button on the steering wheel.



Do not operate engine at low idle for long periods with engine coolant temperature below the minimum specification in your diesel engine manual. This can result in the following:

- Fuel dilution of the lubricating oil
- Carbon build up in the cylinder
- Cylinder head valve sticking
- Reduced performance

**Further Information**

See the chassis manual in your InfoCase for complete operating instructions and other information on all of the features of your SmartWheel.

---

---

**BATTERY BOOST SWITCH**

The Battery Boost switch can be used to draw emergency starting power from the house batteries to start the engine if the chassis battery is discharged.

Press and Hold the Battery Boost switch in the ON position while turning ignition key for emergency starting power.

*NOTE: The House/Coach Battery Disconnect switch near the entrance door must be ON and house batteries must be sufficiently charged for this feature to work.*

## SECTION 3 – DRIVING YOUR MOTORHOME



Battery Boost Switch  
(Located on dash)

\* If chassis battery is discharged, press and hold while turning ignition key for emergency starting power  
-Typical View

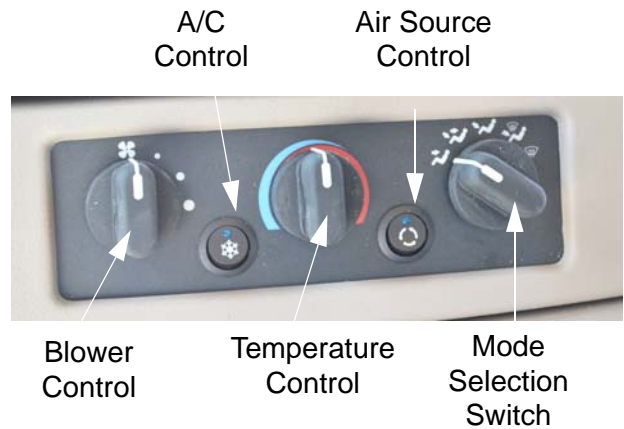

Blower Control      Temperature Control      Mode Selection Switch

-Typical View

*NOTE: The dash air conditioner/heater is not designed to heat and cool the entire interior of the coach, but is intended only to provide heating and cooling for the cab area.*

*A small amount of air will blow out all of the defrost and the dash vents regardless of the mode setting.*

---

### AIR CONDITIONER/HEATER – AUTOMOTIVE (DASH)

Controls for the air conditioner, heater, defroster, and vent are located on the dash. Your coach is equipped with one of the following controls.

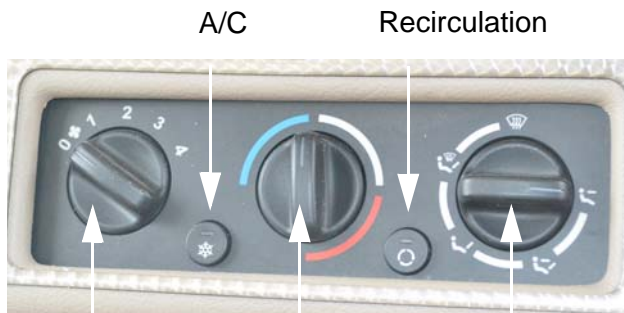

Blower Control      Temp Control      Mode Selector

-Typical View

### Further Information

See the manufacturer's user guide provided in your InfoCase for complete operating instructions.

---

### DEFROST FANS

#### -If Equipped

The two-speed auxiliary fans are intended to assist the automotive windshield defroster system in clearing fog and frost in cold weather or humid conditions.

- HIGH - For maximum defrost output, press the Defrost Fan switch UP.
- LOW - For lower defrost output, press the Defrost Fan switch DOWN.
- The middle position on the switch is OFF.





**Defrost Fan Switch**  
(Located on dash)  
-Typical View

---

---

## **AIR HORNS**

### **-If Equipped**

Press the Air Horn switch (located on the dash or driver side trim panel, depending on model) to the ON (up) position - then use the horn button on the steering wheel to sound the air horns. The switch enables the air horn system to work with the standard chassis horn.

Press the Air Horn switch OFF (down) to disable the air horns.

The air horn sound units are located behind the front grille assembly.



**Air Horn Switch**  
(Located on dash or driver side trim panel)  
-Typical View

---

---

## **FUEL SELECTION – DIESEL ENGINE**

Refer to your chassis manual for the manufacturer's recommendations on proper fuel selection (ULSD fuel only).

### **Winter Fuel Waxing and Anti-Gel Additives**

In sub-freezing temperatures, #2 diesel fuel can form small wax crystals that become trapped in the fuel filter and block the fuel flow to the engine, causing it to stall out. At sub-zero temperatures, the fuel can congeal and turn “slushy.” If this happens, the only remedy is to have the vehicle towed into a heated facility to allow the fuel to warm up and become fully liquid again.

During winter time, most truck stops and reputable filling stations have winter blend diesel fuels available that are less susceptible to waxing.

There are also commercially available products (typically called anti-gel additives) to add to diesel fuel while filling the tank to inhibit wax formation in freezing temperatures.

### **Further Information**

Consult your chassis manual or diesel engine guide in your InfoCase for more information on fuel requirements and additives.

---

---

## **FILLING THE FUEL TANK – DIESEL ENGINE**

Diesel fuel can foam up while being pumped into the tank. Sometimes this foam can cause the pump nozzle to shut off before the tank is actually full. Allow the foam to settle, then resume filling at a slower flow rate until the tank is full.

---

---

## **STARTING AND STOPPING DIESEL ENGINE**

See also “Engine Block Heater” elsewhere in this section.

## SECTION 3 – DRIVING YOUR MOTORHOME

*NOTE: Never attempt to start the vehicle by hot-wiring.*

### Idling Diesel Engine

Do not idle the engine for excessively long periods.

**IMPORTANT:** Long periods of idling are not good for an engine because the combustion chamber temperatures drop so low that the fuel may not burn completely. This will cause carbon to clog the piston rings and may result in stuck valves.

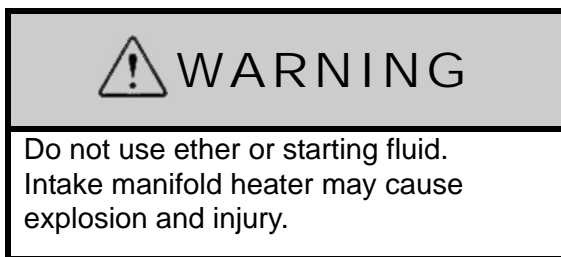

### Further Information

Refer to the chassis manual provided in your InfoCase for the manufacturer's recommendations on starting and stopping the engine.

---

---

## ENGINE BLOCK HEATER – DIESEL ENGINE

Your diesel engine is equipped with an engine coolant heater to assist starting in freezing temperatures. The power cord is located in the rear cargo compartment on the driver side of the coach. When plugged into the receptacle, the heater is connected to both the shoreline and the auxiliary generator, so a separate extension cord is not needed. The power switch is located on the touch tablet.



Touch Tablet Main Menu

- Tap on "Exterior" (selection displays in white).



Diesel Engine Heater Switch  
(Located on touch tablet "Exterior" screen)

Tap to turn Block Heater on/off

- White text indicates ON
- Black text indicates OFF

-If Equipped

**REMEMBER!** Turn the Diesel Engine Heater switch OFF after starting the engine. The heater will keep operating for as long as it is supplied with electricity. If the switch is left on, the engine heater will come on each time you hook up the shoreline cord or start the generator. The block heater can be damaged if left on for an extended period of time.

---

---

## ENGINE SERVICE ACCESS GRILLE – REAR

The diesel engine is located behind the grille panel at the rear of the vehicle.

Release the latches located at the top of the grille panel and swing out toward you.



**Engine Service Access Grille**  
(Release latches and swing grille out)  
-Typical View

With the grille panel open, you can access the following service points:

- Engine Oil Dipstick
- Engine Oil Fill Cap
- Power Steering Reservoir
- Radiator Cap (rear radiator only). On side radiator vehicles, the radiator is located on the driver side rear.
- Engine Coolant Reservoir
- Transmission Dipstick/Fill Tube
- Air Filter Restriction Indicator
- Engine Diagnostic Connector

**Service Points with Side Radiator**

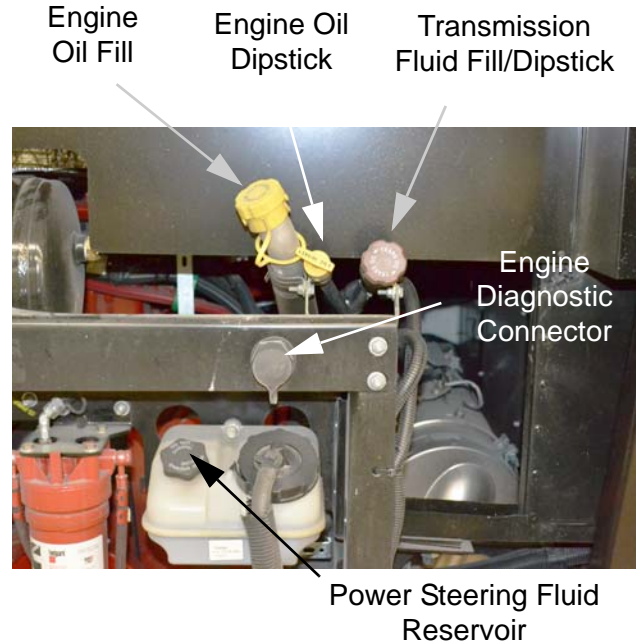
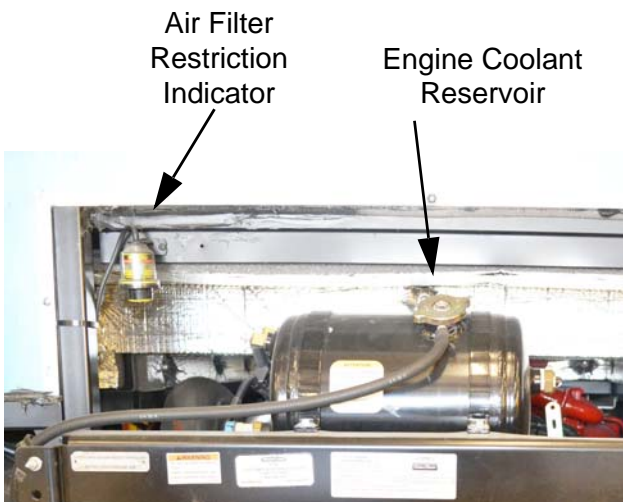

**ENGINE ACCESS COVERS –  
REAR BATH**

The Engine Access Covers are only removed if a complete view of the engine is needed for inspection, or for replacement or adjustment of upper engine parts.

The Forward Engine Access Cover is located beneath the rear bath floor and the Rearward Engine Access Cover is located beneath the lavatory cabinet or inside the bathroom wardrobe floor, depending on model.

Take precautions to protect carpet and interior furnishings when removing Engine Access Covers. The undersides of the covers could contain deposits of oil and fuel or other engine fluids and substances that could damage fabrics and interior furnishings.

**Forward Engine Access Cover  
(Beneath rear bath floor)**

1. Remove rear bathroom rug (if equipped) and set aside.
2. Using the Engine Cover Latch Key (located on your key ring), unlock the center Engine Cover Latch by turning counter-clockwise.

## SECTION 3 – DRIVING YOUR MOTORHOME

---



Engine Cover Latch Key  
(Located on key ring)



Engine Cover Latch  
-Typical View

3. Using a Suction Cup Lift, remove unlocked Forward Engine Access Cover and set aside.

*NOTE: Use care when removing the Engine Access Cover to avoid possible interior damage.*



4. Remove fasteners from metal engine access cover and set cover aside.

5. Reverse steps to reinstall engine access cover.

### Rearward Engine Access Cover (Beneath lavatory cabinet)

In some cases, you may need further access of the rear engine (beyond removing the Forward Engine Access Cover, as described in Steps 1 through 5.) A Rearward Engine Access Cover is located beneath the lavatory cabinet or bathroom wardrobe, depending on model.

#### Model 42HL and 42QL

- Remove screws that attach the white access panels below lavatory cabinet. Remove panels and set aside.

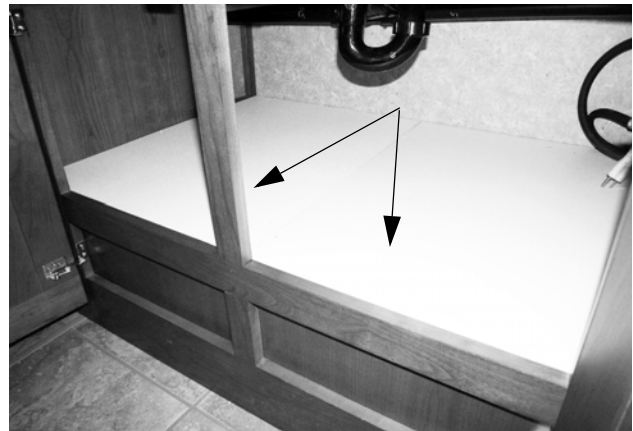

Access Panels  
(Located below lavatory cabinet)

- Remove fasteners from metal engine access cover and set cover aside.

*NOTE: Removal of the lavatory cabinet face is required before removing Metal Engine Cover.*

- Reverse steps to reinstall engine access cover, access panels, and lavatory cabinet face.

#### Model 45RL

- Remove screws around access panel on bathroom wardrobe floor. Remove panel and set aside.



Access Panel  
(Located on bathroom wardrobe floor)

- Remove fasteners from metal engine access cover and set cover aside.

---

---

## FUEL/WATER SEPARATOR – DIESEL

### Freightliner® Chassis

Diesel fuel often contains small quantities of water, which can damage the engine if not filtered out. The Fuel/Water Separator traps this water and prevents it from reaching the engine. The harmful water deposits must be drained from the separator canister during normal periodic service and maintenance to keep the fuel filtration system working effectively.

The Fuel/Water Separator is located behind the rear engine access door.

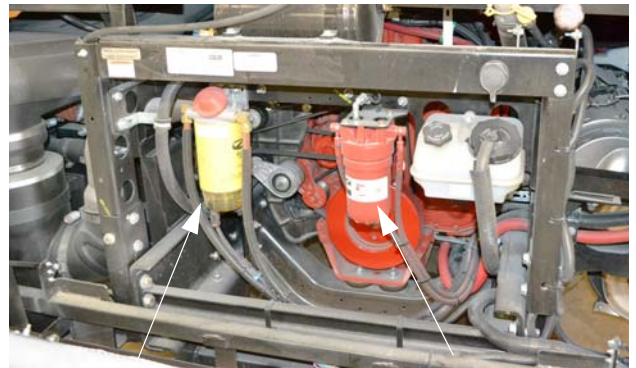

Diesel Fuel/Water  
Separator (Filter)

Fuel Filter

(Located behind rear engine access door)  
-Typical View

Place an appropriate container beneath the bottom of the Fuel/Water Separator Filter and open the water release drain valve several turns. Drain any water deposits from the canister until clean diesel fuel flows from the valve. Close valve by hand. Do not over tighten.



Fuel/Water Separator Drain Valve  
(Located on bottom end of separator)  
-Typical View

- Turn counter-clockwise (left) to open
- Turn clockwise (right) to close

Dispose of the drained liquid in an environmentally responsible manner, such as taking to a waste oil disposal center.

---

---

## DIESEL EXHAUST FLUID FILL

The Diesel Exhaust Fluid Fill is located in the passenger side compartment behind the rear wheel.

## SECTION 3 – DRIVING YOUR MOTORHOME

*NOTE: Use only certified diesel exhaust fluid (DEF) in the Diesel Exhaust Fluid Fill tank.*



Diesel Exhaust Fluid Fill Tank  
\*with Side Radiator  
(Located in passenger side  
compartment behind the rear wheel)  
-Typical View



Diesel Exhaust Fluid Remote Fill  
\*with Side Radiator  
(Located on driver side forward  
of side radiator)  
-Typical View

### Further Information

Refer to the chassis manual provided in your InfoCase for complete information and precautions.

---

---

## ENGINE COOLING SYSTEM

Do not remove the radiator cap while engine and radiator are still hot. Always check coolant level visually at the see-through coolant reservoir.

*NOTE: Your chassis engine cooling system is filled with special extended-life coolant that is not the same as common anti-freeze available at retail outlets. The coolant system MUST be refilled or topped up with the same type of coolant as equipped to maintain the special long-life properties.*

### NOTICE

When refilling the coolant system of a vehicle equipped with a rear auxiliary automotive heater and motoraid water heater, be sure to allow for additional coolant capacity of the heater and its supply and return hoses.

### Further Information

Refer to the chassis manual in your InfoCase for information and precautions on filling, servicing, and checking the fluid level.

---

---

## CHASSIS BATTERY DISCONNECT SWITCH

The Chassis Battery Disconnect switch disconnects most chassis electrical loads from the chassis (starting) batteries to avoid discharge by constant draws such as engine computers, radio clock, sensors, etc. (except the electric entrance step). This feature is intended to help conserve battery charge during storage.



Chassis Battery Disconnect Switch  
(Located near entrance door)  
-Typical View

- These switches illuminate when the House/Coach Battery Disconnect switch is ON.

Turn the switch to the OFF or ON positions to disconnect or reconnect the chassis batteries.

*NOTE: The Chassis Battery Disconnect switch must be on to start the engine.*

## CIRCUIT BREAKERS AND FUSES – CHASSIS/DASH AUTOMOTIVE 12-VOLT

The fuses, breakers, and relays for automotive chassis and dash features are conveniently located on the main 12-volt electrical panel in the front left exterior compartment.

The circuit breakers pop outward if they are tripped. Simply push in to reset.

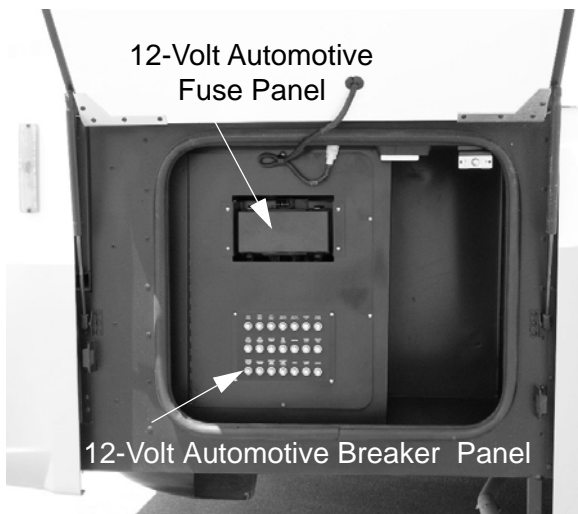

Automotive Circuit Breakers (push to reset)  
• Breakers are labeled for components equipped

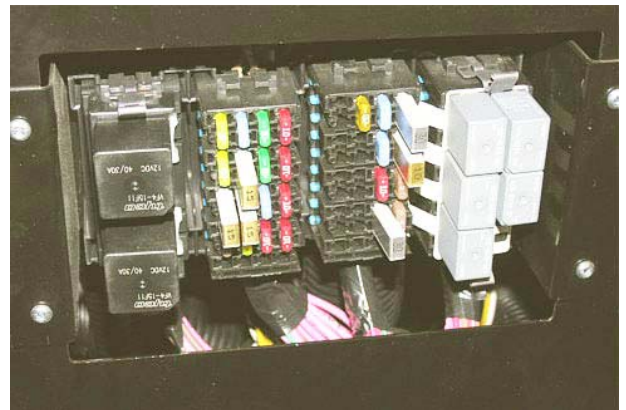

Automotive Fuses (cover removed)

Always replace plug-in type fuses with those of the same amperage size.

See the chassis manufacturer's fuse allocation chart on the inside of the fuse block cover.



Fuse Diagram (inside of cover)

## SECTION 3 – DRIVING YOUR MOTORHOME

### Further Information

See your chassis manual in your InfoCase for further information about chassis supplied fuses and relays.

---

---

### FRONT SERVICE ACCESS

#### (Power Generator Tray)

The front hood panel is featured with a power generator tray, which extends and retracts with a touch of a switch to easily access items such as the air hose connector, windshield washer fluid reservoir, and generator.

#### To Extend Power Generator Tray

- Open the Generator Tray Power Switch Cover (located in the front driver side compartment) and extend completely to the fully outward position to UNLOCK the generator tray.

<h3>NOTICE</h3>
-----------------

Fully open the Generator Tray Power Switch Cover and hold open to disengage tray lock. Failure to comply may result in damage. See Operator's Manual.
---

#### Generator Tray Power Switch

- Generator Tray Power Switch Cover**
- Extend completely to the fully outward position to UNLOCK generator tray

- Press and hold the switch in the EXTEND position to open the generator tray.
- Press and hold the switch in the RETRACT position to close the generator tray.

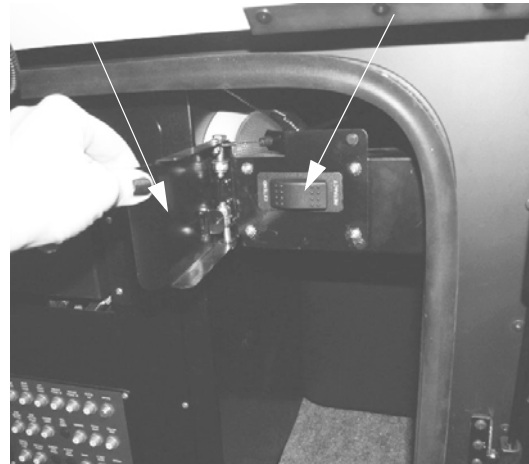

Generator Tray Power Switch and Cover  
(Located in front driver side compartment)

- While continuing to hold the switch cover open, press and hold the Generator Tray Power Switch in the EXTEND position to open the generator tray.

*NOTE: The generator tray will come to a stop and you will hear an audible “clicking” sound when it is fully extended.*





### To Retract Power Generator Tray

- Open the Generator Tray Power Switch Cover.
- Press and hold the Generator Tray Power Switch in the RETRACT position until generator tray is in the fully CLOSED position.

*NOTE: The generator tray will come to a stop and you will hear an audible “clicking” sound when it is fully retracted.*

- Close the Generator Tray Power Switch Cover.

*NOTE: When the switch cover is closed after the generator tray is fully retracted, the generator tray will engage into locked position.*

### Further Information

Refer to the manufacturer’s instruction manual provided in your InfoCase for further information, including manual retraction instructions.

---

---

### WINDSHIELD WASHERS AND WIPERS

The Windshield Washer Fluid Reservoir is located behind the front hood panel (see “Front Service Access” elsewhere in this section for instructions on opening the hood panel).

We recommend using commercially available premixed solutions for best results. Avoid using water in freezing temperatures, as the washer pump could become damaged.

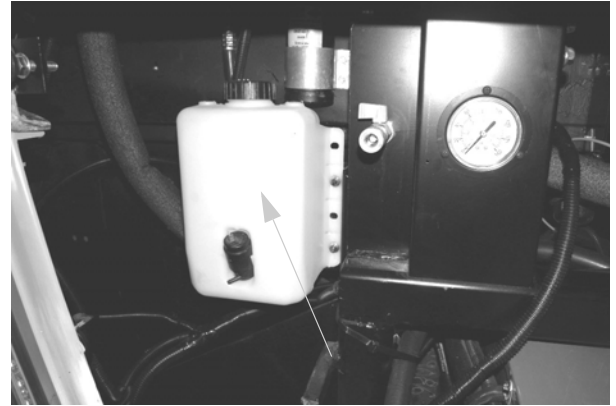

Windshield Washer Reservoir  
(Located behind front hood panel)  
-Typical installation shown

---

---

### TIRES

Improper tire pressure can result in tire overloading and abnormal wear and also affects handling, ride characteristics, and fuel economy.



---

---

### HUB COVER

#### Freightliner® Chassis supplied with Alloy Wheels

- To remove the rear hub cover, locate the hub cover wrench (with directional indicator arrows) from the InfoCase.



Hub Cover Wrench  
-Typical View

## SECTION 3 – DRIVING YOUR MOTORHOME

---

### Attach the hub cover wrench to the hub cover.

- Align the hex of the wrench opening with the hex of the hub cover center nut and move wrench inward until the nut surface is outboard of the wrench.

### Driver Side (left hand thread)

- To Remove turn clockwise.
- To Install turn counter-clockwise.

### Passenger Side (right hand thread)

- To Remove turn counter-clockwise.
- To Install turn clockwise.



### Further Information

Contact Freightliner® Custom Chassis for more information: 1-800-FTL-HELP (1-800-385-4357).

---

---

## SUSPENSION ALIGNMENT AND TIRE BALANCE

The front suspension and steering system of this vehicle was factory aligned using highly accurate equipment prior to delivery to the dealership. However, alignment should be checked and adjusted after you have fully loaded the motorhome according to your personal needs. Thereafter, the alignment should be periodically inspected to help prevent uneven tire wear.

Any excessive or abnormal tire wear may indicate worn or misaligned suspension or steering, unbalanced tire, or other tire/suspension problem.

Alignment can be affected by worn steering/suspension parts or by incidents which happen during driving, such as hitting a curb, pothole, or railroad track, etc. Improper alignment can cause tires to roll at an angle and wear unevenly. It may also cause the vehicle to “pull” to the right or left. Have your dealer inspect your vehicle’s suspension and steering components periodically for misalignment or wear.

Out-of-balance tires will not roll smoothly and can lead to vibrations and uneven tread wear, such as cupping and flat spots. Tires may need to be balanced if uneven wear is detected or if ride comfort decreases noticeably.

### Further Information

Refer to the chassis manual provided in your InfoCase for further information.

---

---

## LIGHTS

All exterior lights should be checked for proper operation each time the vehicle is prepared for a trip. Any bulbs which fail to light should be checked and replaced, when necessary, with a new bulb of the same size. A failure of more than one light, such as both taillights not operating, may indicate a burned out fuse. Check fuse and replace with one of the same rating when necessary. If a fuse is not the cause of the problem, the wiring system should be checked immediately by an authorized service center.

### Further Information

Refer to the chassis manual in your InfoCase for further information.

## SECTION 4 – APPLIANCES AND SYSTEMS

---

The appliances installed in your motorhome are manufactured by reputable RV appliance makers and have been tested by independent laboratories to meet all applicable standards and codes set for RV appliances.

See *Section 2 - Safety and Precautions* of this manual for any safety and precautions you need to take regarding the operation of your appliances.

---

### REFRIGERATOR – RESIDENTIAL

#### **–If Equipped**

Your coach may be equipped with a “residential style” refrigerator, which features a filtered external water and ice dispenser, among many more key features. This refrigerator operates off of the 120-volt electrical system in your coach.

In order to operate, the refrigerator requires either the shoreline to be plugged in, the generator running, or inverter power.

The inverter is intended to power your 120 volt residential refrigerator primarily when driving your vehicle. The house batteries will drain quickly if the refrigerator is powered from the inverter when the engine is not running. Other 120 volt appliances and other 120 volt devices are not intended to operate with inverter power for long periods of time as they too will quickly drain your house batteries.

*NOTE: The refrigerator operates off of 120-volt power. When power is off, the ice maker drain valve (located behind sidewall access compartment) needs to be in the ON position. This will ensure that water does not discharge from the water dispenser when power is reconnected to the appliance.*

Temperature controls are factory preset for your convenience. See the manufacturer’s user guide provided in your InfoCase for information on adjusting refrigerator/freezer temperatures to best suit your needs.



### WARNING

At refrigerator/freezer or motorhome End of Life remove travel latch. Failure to remove travel latch could result in trapping a child inside resulting in suffocation leading to death or serious injury.

Do not let children play inside the motorhome unattended. Unlike your home refrigerator/freezer that one could push open the door from the inside, your motorhome refrigerator has a travel latch and when engaged would trap a child inside.

### Freezer Travel Latch

#### **–If Equipped**

Turn the Freezer Travel Latch (located on left refrigerator door at bottom) downward to prevent freezer door from opening. To open freezer door, turn Travel Latch upward to unlock.

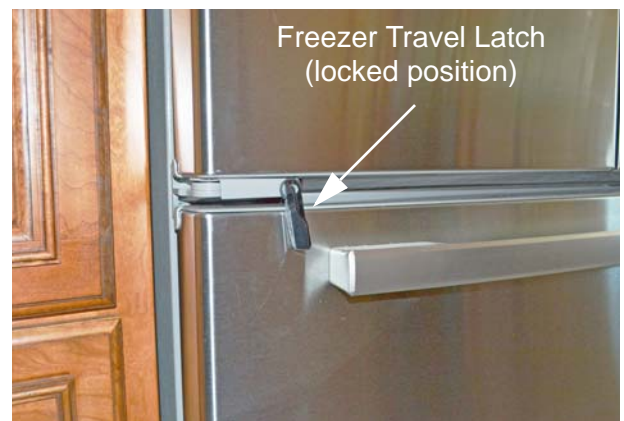

-Typical View

## SECTION 4 – APPLIANCES AND SYSTEMS

---

### Refrigerator/Freezer Travel Strap –If Equipped

Attach one end of strap to both Refrigerator door handles and the other end of strap to the Freezer door handles (as shown in the following photo) to prevent the refrigerator and freezer doors from opening. Ensure the strap is secured.



Refrigerator/Freezer Travel Latch  
(locked position)  
-Typical View

### Basic Refrigerator Operation

- Press the On/Off button to start up the refrigerator.
- Press and Hold the On/Off button for three seconds to turn off the refrigerator.

*NOTE: Allow 24 hours for your refrigerator to cool completely before storing food.*

### Basic Freezer Operation

- Press the ice maker switch to the On position to start up the ice maker.
- To turn off the ice maker, press the ice maker switch to the Off position.

*NOTE: The ice maker On/Off switch is located on the ice maker itself.*

*Your ice maker is equipped with an automatic shutoff, which has sensors to automatically stop ice production (but the control will remain in the On position).*

### Replacing the Water Filter

The water filter is located in the upper right-hand corner of the refrigerator compartment.

Your refrigerator is equipped with water filter indicator lights, which remind you when it is time to order and replace the water filter. When the yellow (Order) light comes on, it is almost time to change the filter. When the red (Replace) light comes on, a new water filter should be installed.

It is recommended to replace the water filter when the indicator light changes to red, or earlier if the flow of water to your water dispenser or ice maker noticeably decreases.

See the manufacturer's user guide included in your InfoCase for water filter ordering information.

*NOTE: Air trapped in the water system may cause the filter to eject. Always dispense water for at least 2 minutes before removing the filter.*

### Removing/Replacing the Water Filter

- Turn water filter counter-clockwise and pull down.
- Remove sealing label from replacement filter and insert the filter end into the filter head.
- Turn the filter clockwise until it stops.
- Snap the filter cover closed.

*NOTE: Flush four gallons of water through water filter before use.*

### Further Information

See the manufacturer's user guide provided in your InfoCase for further key features as well as operating, safety, maintenance, and troubleshooting information.

---

---

## ICE MAKER

The refrigerator in your coach is equipped with an automatic ice maker system. The ice maker unit is installed in the freezer compartment of the refrigerator.

*NOTE: A water shut-off valve for the ice maker is located near the water faucet filter inside the galley cabinet beneath the sink or behind the bottom drawer in the galley pantry, depending on model.*

### **Further Information**

Refer to the refrigerator manufacturer's user guide provided in your InfoCase for complete operating instructions and maintenance information.

---

---

## **REFRIGERATOR SERVICE ACCESS COMPARTMENT – RESIDENTIAL**

### **(Exterior)**

The exterior residential refrigerator service compartment allows access to the rear of the refrigerator for inspection, maintenance, and service.

- Unlock access compartment with provided key (located on your key ring).



Residential Refrigerator  
Service Compartment  
(Located along driver or passenger  
sidewall, depending on model)  
-Typical View

---

---

## **TAILGATE PACKAGE**

### **–If Equipped**

Your coach may be equipped with a single burner electric range and refrigerator/freezer, which is mounted on a slide tray in a passenger side storage compartment.

- To extend the slide tray, release the slide tray lock mechanism by lifting UP.



- Grasp the underside of the slide tray and extend.



- To store slide tray, push unit in fully until the lock mechanism engages.

### **Further Information**

See the appliance manufacturer's user guide provided in your InfoCase for complete operating instructions, safety precautions, and maintenance care.

## SECTION 4 – APPLIANCES AND SYSTEMS

---

---

### REFRIGERATOR/FREEZER – PORTABLE

#### –If Equipped

Your coach may be equipped with a 12/24-volt DC Portable Refrigerator/Freezer, which is mounted on a slide tray in a passenger side storage compartment.

- To extend the refrigerator/freezer unit for easier access, release the slide tray lock mechanism by lifting UP.



- Grasp the underside of the slide tray and extend.



- To store refrigerator/freezer, push unit in fully until the lock mechanism engages.

### Further Information

Refer to the manufacturer's user guide provided in your InfoCase for complete operating instructions, safety precautions, and maintenance information.

---

---

### RANGE TOP (ELECTRIC)

#### –If Equipped

*NOTE: See the appliance manufacturer's user guide provided in your InfoCase for complete operating instructions and safety precautions.*

The range in your motorhome operates on electricity and will provide most of the functions of the range in your home.

Refer to the appliance manufacturer's user guide provided in your InfoCase for complete range features and operating instructions.



### Avoiding Asphyxiation

Unlike homes, the amount of oxygen supply is limited due to the size of the recreational vehicle, and proper ventilation when using the cooking appliances avoids dangers of asphyxiation.

It is especially important that cooking appliances not be used for comfort heating, as the danger of asphyxiation is greater when the appliance is used for long periods of time.

**! WARNING**

Portable fuel-burning equipment including wood and charcoal grills and stoves, shall not be used inside the recreational vehicle. The use of this equipment inside the recreational vehicle can cause fires or asphyxiation. Failure to comply could result in death or serious injury.

---

---

## MICROWAVE/CONVECTION OVEN WITH RANGE HOOD

### -If Equipped

The range hood vent is built into the microwave oven. The range hood fan carries cooking odors and gas fumes to the outside of the coach. A light on the underside of the hood provides illumination for food preparation. The hood fan and light switches are located on the microwave control panel.

**NOTICE**

Do not store items in oven. If oven would turn on stored items can ignite resulting in fire and or property damage.

### Further Information

See the manufacturer’s user guide provided inside the appliance for complete operating instructions and replacement of vent hood light bulbs and replacement or cleaning of grease filter elements.

---

---

## MONITOR PANEL

### -If Equipped

The Multiplex Switch Panel (located in the OnePlace and exterior water service center) provides a convenient, central location for checking the condition of the utility systems in

your coach. The switch panel displays the fresh water and holding tank levels, as well as the house battery condition.

Water and Holding Tank Levels



House Battery

Monitor Panel  
-Typical View

### Water And Holding Tank Levels

The approximate fluid levels are measured by electronic sensors on the sides of the tanks. Tank levels are displayed as Empty (0%), 1/3 (33%), 2/3 (66%), and Full (100%). There is generally more fluid in a tank than indicated on the monitor panel.

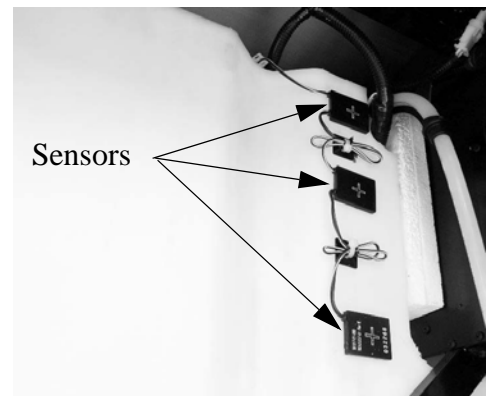

Water Tank  
-Typical View

### Tank Capacities

See “Tank Capacities” in *Section 1 - Introduction*.

### Battery Charge Meter

To get an accurate reading:

## SECTION 4 – APPLIANCES AND SYSTEMS

- Both the chassis engine and the generator engine must be shut off and 120-volt AC shoreline unplugged.
- An interior light should be turned on to provide a small load which draws off the battery surface charge.

---

---

### MONITOR PANEL (TOUCH TABLET)

#### –If Equipped

The Touch Tablet provides a convenient, central location for checking the condition of all utility systems in your coach.

At the touch of a button, the touch tablet will display the fresh water and holding tank levels, propane gas tank level, plus the chassis battery and house battery condition. You can also turn the water pump and water heater on and off.

For your convenience, a multiplex switch panel is located in the exterior water service center.

### Message Center



“Home” Screen



Message Center Information Screen

The Message Center (on the “Home” screen) gives you quick, easy access to warnings and notifications being reported by many systems in your coach.

Tap the top of the Message Center to go to the Warnings and Notifications screen where you will find detailed information about each system being monitored and you can mute the audible alarm.

When there is more than one message, they will cycle through, displaying each message for three (3) seconds. Tap on any message to get more information about the warning.

The number at the bottom of the message center indicates the current number of warnings and notifications being reported. Tap “next” to cycle quickly through the messages.



**Water And Holding Tank Levels**

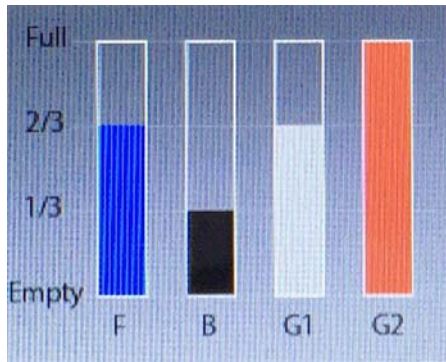

Tank Levels

Water and Holding Tank Levels are located on the “Home” Screen. Tank Level Indicators are as follows: F = Fresh, B = Black, G1 = Grey 1, G2 = Grey 2. When Fresh Tank is near empty and Black or Grey tanks near full, their indicator will turn red.

The approximate fluid levels are measured by electronic sensors on the sides of the tanks. Tank levels are displayed as Empty (0%), 1/3 (33%), 2/3 (66%), and Full (100%). There is generally more fluid in a tank than indicated on the monitor panel.

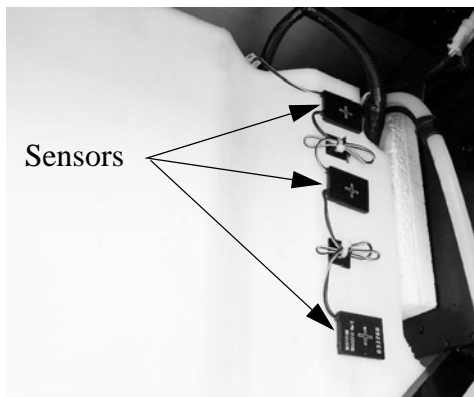

Water Tank  
-Typical View

**Tank Capacities**

See “Tank Capacities” in *Section 1 - Introduction*.

**Battery Charge Meter**

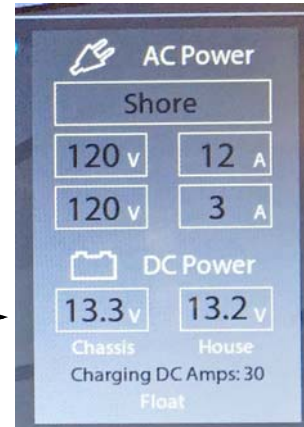

Power Information Screen  
(Located on “Home” Screen)

- Volts currently available from Chassis and House Battery.

To get an accurate reading:

- Both the chassis engine and the generator engine must be shut off and 120-volt AC shoreline unplugged.
- An interior light should be turned on to provide a small load which draws off the battery surface charge.

**Generator Start/Stop Switches and Hourmeter**

See *Section 6 - Electrical* for generator start-up/shut-down and generator hourmeter instructions.

The Generator Switch turns the generator on/off as well as reports the approximate number of total hours the generator has run.

## SECTION 4 – APPLIANCES AND SYSTEMS



Generator Switch  
(Located on “Home” Screen)

- Push and Hold for 10 seconds to turn on.
- White text indicates ON
- Push and Hold for 3 seconds to turn off.



Touch Tablet Main Menu

- Tap on “Utilities” (selection displays in white).



PCS Display Panel

(Located on touch tablet “Utilities” screen)

Tap to select shore power amp setting.

- The white arrow designates selection.

-If Equipped

## POWER CONTROL SYSTEM (PCS)

The Power Control System (PCS) monitors the electrical usage of the appliances and equipment in the coach and allows you to use certain high energy appliances, such as the microwave or washer/dryer, without overloading the shoreline or generator circuit breaker to prevent nuisance tripping.



PCS Display Panel

(Located on touch tablet “Home” screen)

- Input Power (Volts)
- Power Consumption (Amps)

-If Equipped

## Further Information

Refer to the manufacturer’s user guide provided in your InfoCase for important information on how this system operates under several conditions, whether 20-amp, 30-amp, or 50-amp connections.

## SOLAR CHARGE PANEL

-If Equipped

The roof-mounted Solar Charge Panel uses the sun to help keep your house batteries charged. A Solar Charge Controller is located near the monitor panel or in an exterior compartment (depending on model) to show you when the Solar Charge Panel is actively charging the house batteries.

The solar charging system installed in your coach has a maximum input rating of 510 Watts. Every solar panel connected to the system needs to be accounted for, this includes all roof mounted panels and the ground level single solar port.



**Solar Charge Controller**  
(Located near monitor panel or in an exterior compartment, depending on model)

### **3-Port Solar Cap**

#### **–If Equipped**

The Port Solar Cap (located on the roof) is intended to make it easy to add additional solar panels to the roof. Each Solar Port has a maximum input rating of 150 Watts. The 3 -Port Solar Cap when fully loaded has a maximum input rating of 450 Watts.



**3-Port Solar Cap**  
(Located on the roof)

### **Single Solar Port**

#### **–If Equipped**

The Single Solar Port (located at ground level) is for using a portable solar panel, it has a maximum input rating of 150 Watts. The Single Solar Port is connected to the coach batteries through the solar charge controller (located on an exterior sidewall or inside an exterior compartment, depending on model). When

connecting a portable solar panel, a separate solar charge controller is not needed and will reduce the effectiveness of the portable solar panel.



**Single Solar Port**  
(Located on an exterior sidewall or inside an exterior compartment, depending on model)

*NOTE: The Solar Charge Panel is not intended to make the coach battery system “maintenance free.” The solar panel will not completely compensate for continuous low amperage draw from components such as the propane gas leak detector, the dash radio clock, and the radio station memory circuitry, for example.*

*Although the Solar Charge Panel can help to extend battery life, the coach shoreline should be plugged in routinely to “top off” the batteries. We also recommend following regular battery inspection and maintenance, especially in cold weather.*

*See “Battery Care” in Section 6 - Electrical.*

### **Further Information**

Refer to the manufacturer’s user manual provided in your InfoCase for complete operating instructions.

## SECTION 4 – APPLIANCES AND SYSTEMS

### THERMOSTAT (TOUCH TABLET)

#### (Heating and Cooling) –If Equipped

The Thermostat (located on touch tablet) controls the Hydronic Heating System, as well as the three separate roof air conditioners in your coach.

#### Basic Operation

The temperature setting control is available from most touch tablet screens. It is located in the lower left hand corner of the touch tablet.

- Climate Control Mode

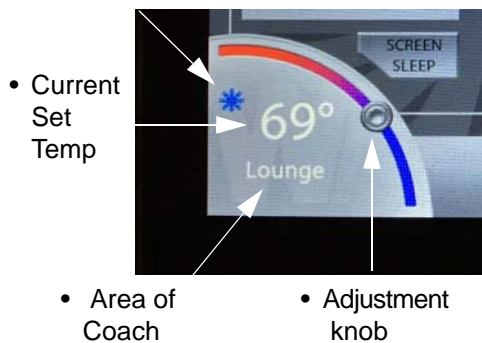

**Thermostat Dial**  
(Located on touch tablet in the lower left hand corner)

- The current temperature shows for the designated area of the coach.
- For quick adjustment of temperature, slide the adjustment knob.

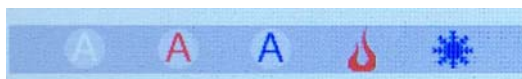

**Climate Control Mode**

#### AUTO

- White “A”: the thermostat is currently off.
- Red “A”: the heat is on.
- Blue “A”: the A/C is on.

FLAME - the mode is set to heat.

SNOWFLAKE - the mode is set to A/C.

To open the climate control set-up screen simply tap on the center of the thermostat dial.

From this screen you can do the following:

- Turn the thermostat Off, select Schedule, or select a Manual mode.
- Choose the desired mode (Heat, Cool, or Auto) for each zone (Front, Mid, Bedroom, or Basement).



Main Thermostat Screen

- White text indicates ON
- Black text indicates OFF

#### Manual Mode

##### Heat

The lounge heating mode is controlled by the “Mid” temperature setting.

1. Select “Manual” mode.
2. Under the desired area of the coach (bedroom or mid-lounge) use button to toggle to “Heat” mode.
3. The Heating system will default to “Heat Pump”. Select the AquaHot Power Source (either Diesel Heat or Electric Heat) if desired.

##### Cool

The lounge cooling mode allows independent temperature settings between the Front A/C and Middle A/C.

1. Select “Manual” mode.
2. Under the desired area of the coach (bedroom, mid, or front) use button to toggle to “Cool” mode.
3. Adjust the temperature.
4. Select the fan speed of your choice (High, Low, or Auto).

### **Auto**

Auto allows you to set both a “Cool” temperature and a “Heat” temperature to automatically maintain a desired comfort temperature.

- Select the desired heat source.
- Fan Speed is Auto only.
- Settings are shared between Bedroom and Lounge to ensure that A/C and Heat Pump cannot be run at the same time.

### **Schedule Mode**

Schedule Mode works similar to a programmable thermostat for your home.

1. Select “Schedule” Mode.
2. Select which area of the coach (bedroom or lounge) you want to set-up.
3. Choose the desired mode (Heat, Cool, or Auto). If Heat or Auto mode is selected, choose the desired heat power source.
4. Adjust the time and temperature.

### **Floor Heat**

The entire floor has a single set point.

- Scale 1-5 (78° - 90°).
- No need to set the Mode, floor heat can be on with A/C.
- Select the AquaHot Power Source (either Diesel Heat or Electric Heat).

### **Heat Pump**

Your coach is equipped with an air source Heat Pump built into the air conditioning system. Because the Heat Pump operates on electricity, it provides economical heat inside your coach and helps reduce the use of diesel fuel for heating in cooler weather.

A Heat Pump can be thought of as an air conditioner running in reverse. An air conditioner absorbs heat from the air on the inside of the coach and moves it to the outside. The Heat Pump does exactly the opposite. Even cold air contains some heat, so a Heat Pump will extract heat from the outside air on a cold day and carry it to the inside of the coach to maintain a comfortable temperature.

The efficiency of a Heat Pump decreases as the outdoor air temperature drops, so supplementary heat is often needed when the outside temperature nears freezing. This system is set to automatically start the Hydronic Heating System to assist the Heat Pump if room temperature cools to 5 degrees or more below the Thermostat set temperature. You may wish to manually switch to Hydronic Heating System heat to maintain a higher temperature when outside temperatures begin to reduce the efficiency of the Heat Pump. The Heat Pump will not operate when the outside temperature falls below 36 degrees F.

*NOTE: Heat Pump capability is not available on front cab A/C units.*

### **Supply and Return Air Vents**

Supply and Return Air Vents are located throughout the ceiling of the coach. The Supply Vents produce airflow. The Return Vents are for air intake, in which the air goes back into the air handler. There is a distinguishable difference between the two - Return Air Vents are equipped with a removable filter inside, and Supply Air Vents are not.

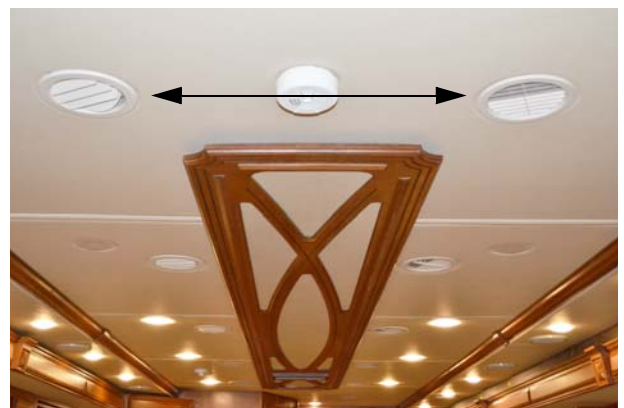

Supply/Return Air Vents  
(Located throughout the ceiling of the coach)  
\* View looking to rear of coach

## SECTION 4 – APPLIANCES AND SYSTEMS



Return Air Vent  
(Shown with filter installed)  
-Typical View

### Condensate Drain Lines

The three roof air conditioners are equipped with condensate water pumps, which allows water that is extracted from the roof air conditioners to be pumped through three separate drain lines (located at the rear of coach).

If you notice water running off of the roof when the air conditioners are running, this is a sign that one or more of the drain lines have plugged and water is now flowing out of the safety overflow of the air conditioner(s).

*NOTE: It is normal for some water to run off the roof when using your air conditioner in “heat pump” mode.*

See your Winnebago Industries® dealer for service and proper cleaning of the drain lines.

### NOTICE

Water running off the roof is a sign the condensate drain lines are plugged and require service. Failure to comply may result in water damage to the roof.

### HYDRONIC HEATING SYSTEM

The Hydronic Heating System in your RV provides a continuous supply of hot water, interior heat, and engine preheating. This system

features a 12-volt DC powered diesel burner (which utilizes on-board diesel fuel) and a 120-volt AC electric heating element, along with a propylene glycol-based antifreeze and water heating solution to give you the luxury of quiet, continuous warmth in your motorhome.

Expansion  
Fill Tank      Exterior Electronic  
Controller

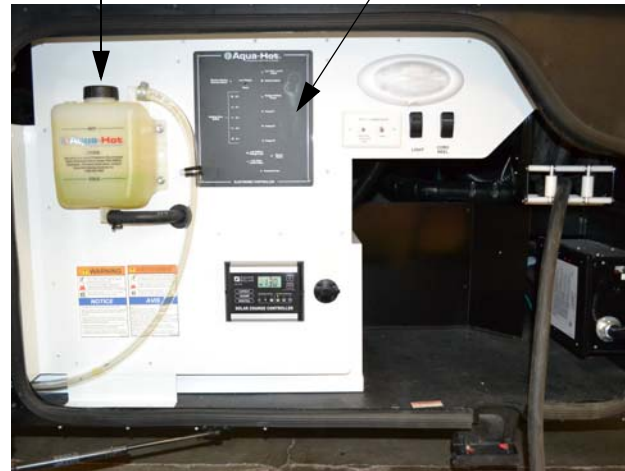

Hydronic Heating System  
(Located in driver side compartment)  
-Typical View



Basement Temperature Control  
(Located on touch tablet)

- Under Basement zone, tap button to select heat.
- Tap to select the Aqua Hot Power Source of your choice “Diesel Heat” or “Electric Heat”.

-If Equipped

## NOTICE

When the water system is in use, the thermostat should never be set below 40-degrees F. to prevent freeze damage to components.

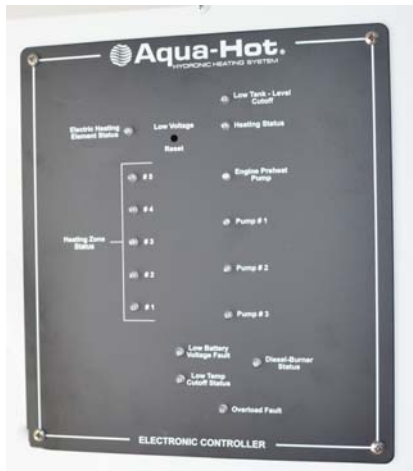

### Exterior Electronic Controller

- Red and green lights indicate the status of your Hydronic Heating System. See manufacturer's operating manual for further information.

*NOTE: If low voltage occurs, the Hydronic Heating System will shut down. Once the voltage level is restored, you must reset the system by turning OFF the diesel burner switch on the interior control switch panel for approximately 30 seconds, then turning the switch back ON.*



### Expansion Fill Tank

- Check antifreeze/water heating solution level monthly. When the system is at maximum operating temperature (i.e. immediately after the diesel burner cycles OFF), the fluid level should be at the level marked HOT.
- If fluid level is low, see the Maintenance Section in the manufacturer's operating manual for replenishing the antifreeze/water heating solution.

*NOTE: Use only Aqua-Hot® approved propylene glycol-based antifreeze.*

## Hot Water

The Hydronic Heating System allows water to be heated as it is being used. A continuous supply of hot water is obtained through a tankless, on-demand hot water system.

## Interior Heat

This system is also equipped with circulation pumps, which allow individual interior heating zones. Whenever the room thermostat calls for heat, the water heating solution is circulated through interior heat exchangers (similar to radiators) located throughout your RV that distributes heat quietly and evenly.

- Zone 1 - Main Living Area
- Zone 2 - Bedroom and Bath(s)
- Zone 3 - Basement

## SECTION 4 – APPLIANCES AND SYSTEMS

### Engine Preheating/Motoraid

Also included in this system is a motoraid feature, which uses heat generated by the RV engine during travel to transfer heat to the water heating solution in the boiler tank. This process allows the boiler tank to remain heated, which reduces the time required to bring the tank to operating temperature for continuous hot water and interior heat.

The Hydronic Heating System also includes an engine preheat feature. This allows for easy engine start-up whenever cold weather conditions exist.



Touch Tablet Main Menu

- Tap on “Exterior” (selection displays in white).

*NOTE: The AquaHot Electric or AquaHot Burner must be on. This can be turned on either by the Thermostat screen or on the Home screen. Tap on Electric Hot Water or Diesel Hot Water.*



Hydronic Heating System  
Interior Control Switches

(Located on touch tablet “Exterior” screen)

- Tap on “AQUAHOT ENG PRE-HT”.  
-If Equipped

The Hydronic Heating System can be operated off of the 120-volt AC electric heating element or the 12-volt DC diesel burner.

*NOTE: Please note that the diesel burner is the primary heat source for heating both the interior and the domestic hot water (such as when cool ambient temperatures exist and/or when there is a high demand for domestic hot water).*

It is recommended that when starting up your RV in extreme cold weather conditions or when you are planning on taking a longer shower, to turn on the diesel burner switch located on your interior control switch panel.

If you normally run the Hydronic Heating System off of the 120-volt AC electric heating element only, it is recommended to fire up the diesel burner monthly as routine maintenance.

### Increasing and Decreasing Water Temperature

A tempering valve is located on the back side of the Aqua-Hot unit for regulating the temperature of the hot water.

Turning the tempering valve an 1/8 of a turn either way will dramatically increase or decrease the water temperature.



- Turn tempering valve COUNTER-CLOCKWISE to INCREASE water temperature.
- Turn tempering valve CLOCKWISE to DECREASE water temperature.





Hydronic Heating System  
Tempering Valve  
(Located on back side of the  
Aqua-Hot unit)



Fuel Nozzle

See “*Winterizing Procedure*” in Section 7 - *Plumbing (ANTIFREEZE FILL PROCEDURE)* for complete instructions in winterizing your Hydronic Heating System. The Aqua-Hot will be winterized along with the rest of the RV water systems.

## Changing the Fuel Filter and Fuel Nozzle

To keep the Aqua-Hot system running smoothly, it is recommended to have the diesel burner tuned up annually. This consists of replacing the fuel filter and the fuel nozzle. To ensure maximum performance, always replace with the fuel filter and fuel nozzle recommended for your Aqua-Hot system.

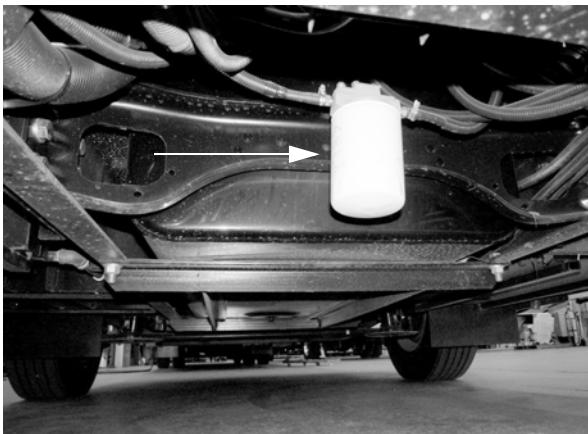

Aqua-Hot Fuel Filter  
(Located in center of coach  
behind front wheels)  
-Typical View

## NOTICE

Do not blow out Aqua-Hot Hydronic Heating System. Failure to comply may result in system damage.

## Further Information

Read the operating, safety, and maintenance information as well as troubleshooting and parts and service information provided in the Hydronic Heating System Operation Manual in your InfoCase.

---

---

## AIR CONDITIONER FILTERS

Air Conditioner Filters are located inside the Return Air Vents throughout the ceiling of the coach and must be inspected monthly and cleaned periodically so the air conditioners will operate efficiently.

## SECTION 4 – APPLIANCES AND SYSTEMS

---



Return Air Vent  
(Grasp louvers and pull straight  
down to remove air vent)  
-Typical View

It is recommended to use mild soap and warm water to clean the air filters. When finished, allow filters to air dry.

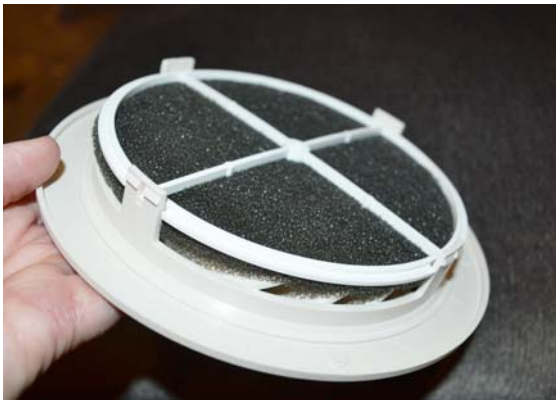

Air Filter  
(Located on back side of Return Air Vent)  
-Typical View

*NOTE: There are multiple Supply and Return Vents throughout the coach. Therefore, you must remember to remove each separate air filter from each Return Air Vent to clean.*

---

### WASHER/DRYER – STACKABLE

#### **-If Equipped**

Your coach may be equipped with a Stackable Washer/Dryer for the luxury of home as you travel.

*Before using the Stackable Washer/Dryer, please spend a few moments reading the manufacturer's user guide provided in your InfoCase for complete operating instructions, troubleshooting and maintenance tips, as well as safety precautions.*



#### **CAUTION**

Open a window or vent while operating dryer. It is dangerous to create a negative air pressure inside a vehicle containing fuel-burning appliances.

### **Water Supply Faucets**

The Washing Machine Water Supply Faucets are located below the lavatory cabinet or inside bathroom wardrobe cabinet, depending on model.

*NOTE: Always turn Water Supply Faucets OFF when not using the Washing Machine to avoid possible water leaks if a hose or hose gasket should fail.*



Water Supply Faucets  
(Located below lavatory cabinet)  
\*Models 42HL and 42QL



Water Supply Faucets  
(Located inside bathroom wardrobe cabinet)  
\*Model 45RL

See “Winterizing Optional Appliances” in *Section 7 - Plumbing* for steps in winterizing your Stackable Washer/Dryer.

### **Cleaning the Pump**

The Washing Machine is equipped with a self-cleaning pump (located behind the cover panel on the lower front of the Washing Machine.) This pump does not require any maintenance, although sometimes small items (such as coins or buttons) may fall into the pre-chamber that protects the pump.

Refer to the “Care and Maintenance” section in the manufacturer’s user guide for steps in removing and cleaning the pump.

### **Further Information**

Refer to the manufacturer’s user guide provided in your InfoCase for complete operating instructions, troubleshooting and maintenance tips, as well as safety precautions.

---

---

### **WASHER/DRYER – PREP PACKAGE**

If your coach is not equipped with a Washer/Dryer, plumbing is present for installation. Water supply faucets are located inside the rear linen cabinet (accessible beneath lavatory cabinet).

We recommend obtaining parts and service for the Washer/Dryer installation from your Winnebago Industries® dealer.

---

---

### **DISHWASHER**

**(Drawer Style)  
–If Equipped**

### **Lock Feature**

The Dish Drawer must be programmed to the “Closed Drawer” autolock feature to keep the drawer locked while driving.

*NOTE: If the power to the dishwasher is disconnected, the drawer will remain locked.*

The dishwasher can be operated by either the remote control (located inside the InfoCase) or by using the wash program panel (located inside the dishwasher).

## SECTION 4 – APPLIANCES AND SYSTEMS

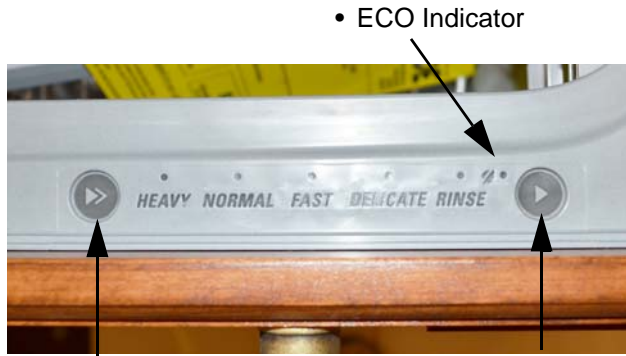

Wash Program Panel  
(located inside the dishwasher)  
-Typical View



Dishwasher Remote Control  
-Typical View

### Basic Dishwasher Operation

5. Press the Wash Program Selector button repeatedly to select a wash setting. The ECO Indicator light will illuminate red when an energy efficient setting has been selected.
6. Press the Start button. Close the drawer to start the wash cycle.
7. The dishwasher will beep six (6) times when the wash cycle is complete.

*NOTE: The dishwasher can be paused with the remote only. Press the remote control button and wait for three (3) beeps before opening the drawer.*

### Further Information

See the dishwasher manufacturer's user guide provided in your InfoCase for complete operating instructions.

---

## CENTRAL VACUUM CLEANER

If your coach is equipped with a central vacuum cleaner, it will be located in a passenger side storage compartment.

The central vacuum cleaner operates on 120-volt household current, so the shoreline must be connected to provide power.

### To Use The Vacuum

Plug the hose into the hose outlet. The Central Vacuum Cleaner will start automatically. When you remove the hose, the vacuum will stop.

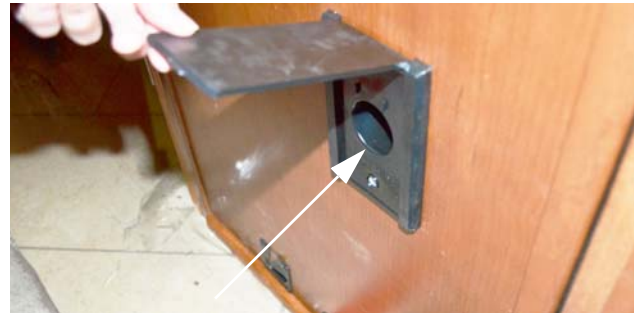

Interior Hose Outlet

### To Use Vac Pan

Press the vac pan lever to the right using your foot to open the door and turn on the vacuum unit. Sweep floor debris into the opening. When you release the spring-loaded door it will automatically shut and turn off the vacuum unit.



## **Exterior Storage Compartment Vacuum**

An additional vacuum hose outlet is located in a passenger side compartment for convenient cleaning of exterior storage compartments and other items outside of the coach.

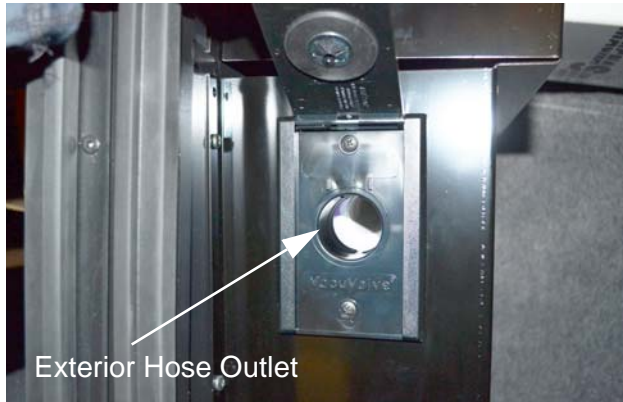

## **To Change Filter Bags**

Pull the cover from the square metal canister. The canister is located in an exterior storage compartment on the passenger side of the coach.

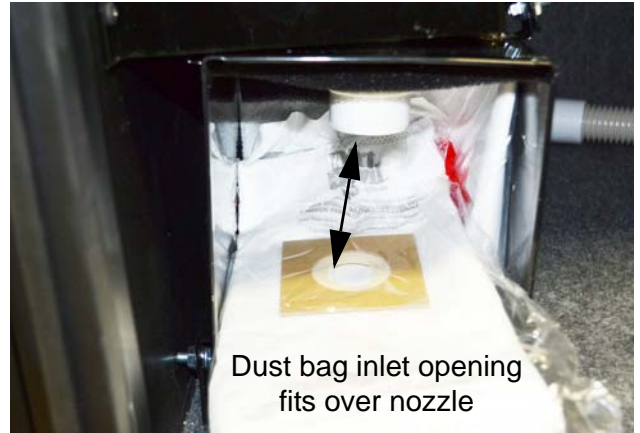
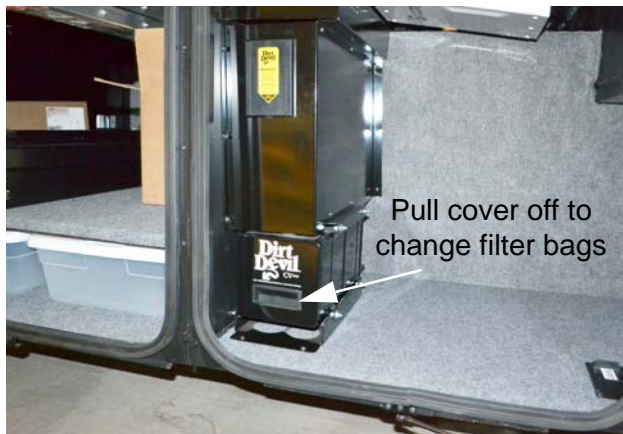

## **If The Vacuum Will Not Start**

Check for a tripped circuit breaker. Also be sure that the vacuum unit is plugged into the electrical outlet in the exterior storage compartment, and the shoreline is connected.



# SECTION 5 – PROPANE GAS

## PROPANE GAS SUPPLY – REMOVABLE

### -If Equipped

The propane gas system supplies LP gas to the Propane Accessory Connection (located behind access door on passenger side of coach).

See *Section 2 - Safety and Precautions* in this manual for other safety and precautions you need to be aware of related to propane.

### How Propane Gas Works

Propane is a type of LP (Liquefied Petroleum) gas compressed into liquid form for easy transportation and storage. Propane gas may also be called tank gas, bottle gas, or simply LP.

Propane is used by appliances in vapor form only, but is stored in the tank as a liquid under very high pressure. As the liquid gas is released, it reverts back to a vapor and expands to many times its compressed volume.

### Propane System

The storage reservoir for the propane gas system is located in a driver side compartment.

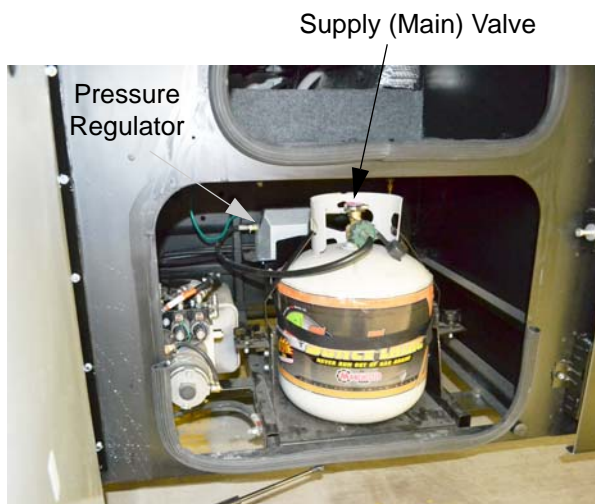

-Typical View

 **WARNING**

Do not place propane cylinders inside the vehicle.  
Propane cylinders are equipped with safety devices that relieve excessive pressure by discharging propane to the atmosphere.  
Propane gas is highly flammable.  
Can lead to a fire or explosion and result in death or serious injury.

### Refilling Propane Cylinder

The LP cylinder must be removed and taken to a propane dealership for filling.

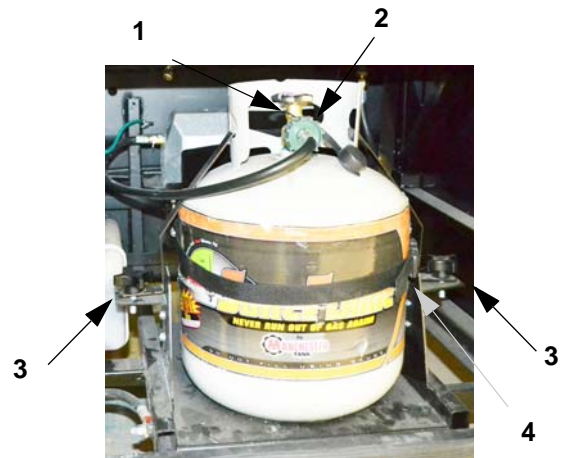

Propane Cylinder Features  
-Typical View

1. Close Supply (Main) Valve.
2. Remove LP Hose from cylinder.
3. Turn the two knobs (located on each side of LP cylinder) and remove hold down brackets from the LP cylinder.
4. Unlatch the security strap.
5. Remove LP cylinder.

Reverse steps to reattach LP cylinder.

*NOTE: Be sure to properly tighten hold down brackets and security strap.*

## SECTION 5 – PROPANE GAS

---



### WARNING

Do not fill propane container(s) to more than 80 percent of capacity. A properly filled container contains approximately 80 percent of its volume as liquid propane. Overfilling propane container(s) can result in uncontrolled propane flow, which could lead to a fire or explosion and result in death or serious injury.



### DANGER

All pilot lights, appliances, and their igniters (see operating instructions) shall be turned off before refueling of motor fuel tanks and/or propane containers. Can cause ignition of flammable vapors, which can lead to a fire or explosion and result in death or serious injury.



### WARNING

This propane piping system is designed for use with propane only. Do not connect natural gas to this system. Securely cap inlet when not connected for use. After turning on propane, except after normal cylinder replacement, test propane piping and connections to appliances for leakage with soapy water or bubble solution. Do not use products that contain ammonia or chlorine to test for leaks. Can lead to a fire or explosion, which could result in death or serious injury.

### Selecting Propane Fuel Types

We recommend using straight propane in your propane cylinder. Propane gas is commonly available at all propane gas outlets in the U.S. (According to the National Propane Gas

Association, propane gas outlets in the United States do not offer any other type of liquefied petroleum gas than propane to the general public.) Check local phone directory yellow pages for locations of local propane gas refilling stations or bulk dealerships.

*NOTE: If you travel outside the U.S. with your motorhome, you may find butane or propane/butane mixtures available in addition to propane. Because gas-burning RV appliances are designed to run on propane only, we recommend that you request straight propane only. Butane burns about 30 percent hotter than propane and can overheat some appliances, particularly refrigerators, and cause permanent damage. Other appliances designed to operate on propane can become sooted and lose efficiency by using butane fuel.*

### Air in the Propane Gas Cylinder

If your gas appliances do not stay lit or require frequent adjustment, even though you know the propane cylinder contains sufficient fuel, the problem may be air in the propane gas cylinder. Air in the cylinder mixes with the propane gas vapors causing them to burn poorly. This condition could linger for weeks if the air is not purged from the cylinder. Most propane gas dealers have equipment for purging air from propane gas cylinders and will purge before refilling the cylinder.

---

---

### PROPANE ACCESSORY CONNECTION

#### –If Equipped

Your coach is featured with a Propane Accessory Connection for your convenience, to connect items such as a portable BBQ grill.

This connection is on the low pressure side of the propane gas pressure regulator. Portable appliances which have an additional or built-in regulator may not operate correctly.



The Propane Accessory Connection is provided with a shut-off valve that has on/off indicator arrows. Rotate the shut-off valve “clockwise” to turn gas supply OFF. Rotate the shut-off valve “counter-clockwise” to turn gas supply ON.

See *Section 2 - Safety and Precautions* in this manual for other safety and precautions you need to be aware of related to propane.

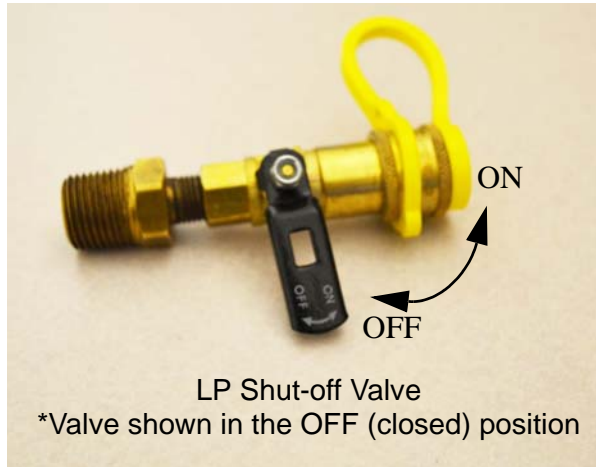

LP Accessory Connection  
(Located behind lockable access  
door on passenger side of coach)  
-Typical View

 <b>CAUTION</b>
Turn valve off when not in use. Secure cap to outlet when not in use. After turning on gas, test gas piping connections to appliance for leakage with soapy water or bubble solution. Do not use products that contain ammonia or chlorine.

## SAFE USE OF THE PROPANE GAS SYSTEM

### **-If Equipped**

The propane system is designed and built with strict adherence to national, state, and recreational vehicle industry requirements for mobile propane gas equipment.

For your safety, there are many safety devices and backup systems installed, such as fill overflow valves, an interior propane gas detector/ alarm, and an interior carbon monoxide (CO) detector/alarm.

Propane gas also contains an odor additive that you can smell if propane is present in the air.

Here are a few precautions to observe that will help you to use the propane gas system safely:

- Exercise caution at all times. Be familiar with the distinctive odor of propane gas. If a leak is suspected, turn off the supply valve immediately. Have the propane gas system checked by your dealer or other qualified propane gas service center.
- Do not tamper with the propane gas piping system, pressure regulator, or gas appliances. Service and maintenance of propane gas system components should be performed only by your dealer or a qualified propane gas service center.
- Never attempt to connect natural gas to the propane gas system.

## SECTION 5 – PROPANE GAS

---

- Have the entire propane gas system inspected for possible leaks and missing or damaged parts at each filling. Also inspect before and after each trip, and any time trouble is suspected.
- Turn the propane supply valve off when not using the propane gas system.
- Never use a wrench to tighten the supply valve. It is designed to close leak-tight by hand. If a wrench is required to completely close the valve, it is defective and must be replaced.
- Be sure appliance and outside vents are open and free from obstruction when using the propane gas system.
- Never attach a lock or any device requiring a key to the propane compartment door. According to standards set for recreation vehicles, the propane supply valve must be readily accessible in an emergency.
- Exercise caution when drilling holes or attaching objects to the walls. Gas lines and electrical wiring could be seriously damaged and present an extreme safety hazard.

---

---

### PROPANE GAS WARNINGS AND PRECAUTIONS

#### –If Equipped

It is illegal for vehicles equipped with propane containers to travel on certain roadways or through certain tunnels in the U.S. To avoid inconvenience, check state regulations concerning flammable gas transportation.

#### Propane Gas Leaks

The following label is located in the vehicle near the range area. If you smell gas within the vehicle, quickly and carefully perform the procedures listed.



### DANGER

#### IF YOU SMELL PROPANE

1. Extinguish any open flames and all smoking materials.
2. Shut off the propane supply at the container valve(s) or propane supply connection.
3. Do not touch electrical switches.
4. Open doors and other ventilating openings.
5. Leave the area until odor clears.
6. Have the propane system checked and leakage source corrected before using again.

Ignition of flammable vapors could lead to a fire or explosion and result in death or serious injury.

- All pilot lights must be extinguished and appliances and their ignitors turned off while refilling the fuel tank or propane container.
- Never smoke while refilling vehicle fuel tank or propane gas container.
- Avoid inhaling exhaust gases produced by burned gasoline, diesel fuel, or propane gas in items such as the range, chassis engine, generator engine, refrigerator, furnace, and water heater. They contain carbon monoxide, which is an odorless, colorless, and poisonous gas.



### WARNING

Do not place propane cylinders inside the vehicle.

Propane cylinders are equipped with safety devices that relieve excessive pressure by discharging propane to the atmosphere.

Propane gas is highly flammable.

Can lead to a fire or explosion and result in death or serious injury.

- Never use an open flame to test for propane gas leaks. Replace all protective covers and caps on propane system after filling. Make sure valve is closed and door latched securely.
- Portable fuel-burning equipment, including wood and charcoal grills and stoves, shall not be used inside the recreational vehicle. The use of this equipment inside the recreational vehicle may cause fires or asphyxiation.
- Regulators are equipped with a protective cover. Make sure that the regulator vent faces downward and that the cover is kept in place to minimize vent blockage, which could result in excessive gas pressure causing fire or explosion.

*NOTE: If your model is equipped with a propane powered electrical generator, there will be two regulators stacked one upon another. One regulates the house propane supply pressure, the other regulates pressure to the generator.*

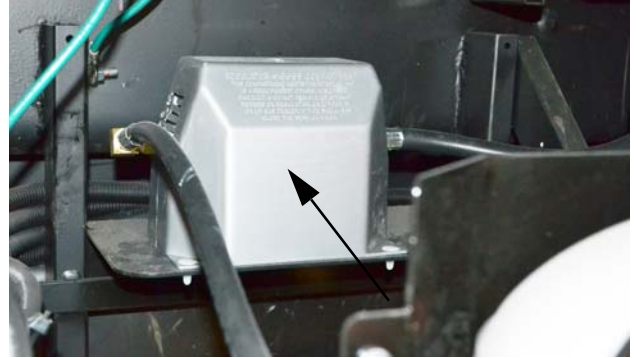

### PROPANE GAS PRESSURE REGULATOR – REMOVABLE LP TANK

#### **-If Equipped**

The pressure regulator is protected from the elements by a plastic cover, which should be left in place at all times.

Propane regulators must always be installed with the regulator vents facing downward. Regulators that are not in compartments have been equipped with a protective cover. Make sure that the regulator vent faces downward and that the cover is kept in place to minimize vent blockage that could result in excessive propane pressure causing fire or explosion.

Only your dealer or a qualified propane gas service should remove the regulator cover for adjustments.

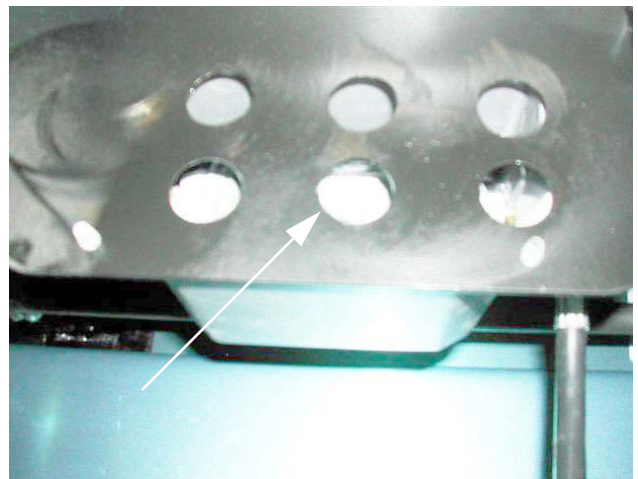

Look up inside hole on underside of regulator housing to see vent screen.

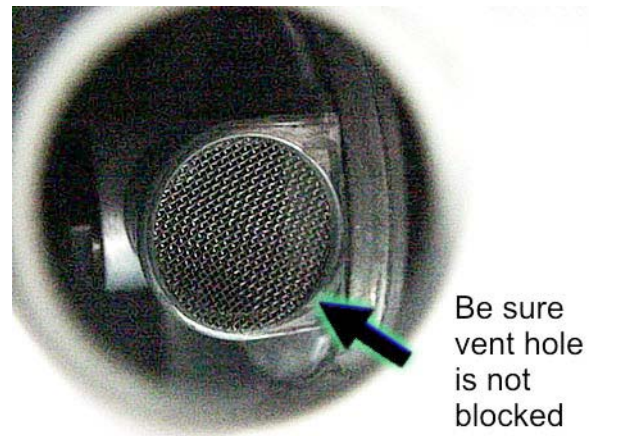

Be sure vent hole is not blocked

#### **WARNING**

Visually inspect the pressure regulator vent periodically for blockage by accumulated debris or insect nests, etc. Vent obstruction could result in excessive pressure causing fire or explosion, which could result in death or serious injury. If an obstruction exists, have the regulator serviced by a qualified service center.

## SECTION 5 – PROPANE GAS

---

### Regulator Freeze-up

Regulator freeze-ups are caused by the presence of moisture in fuel. This moisture will pass through the cylinder valve and into the regulator where it can freeze. Fuel producers, tank and bottle manufacturers, and propane gas dealers take every precaution to reduce moisture, but sometimes only a fraction of an ounce entering the cylinder can cause problems. To help avoid the possibility of freeze-up, always keep control valve closed when not in use, even when cylinder is empty, to prevent moisture from collecting on the inside.

If regulator freeze-up should occur, you may attempt to thaw the regulator using a light bulb. **DO NOT USE AN OPEN FLAME OR HEAT LAMP.**

If moisture begins to cause problems, have your propane gas dealer inject a small amount of dry methyl alcohol in your cylinder (approximately one ounce to 20 pounds or one pint to 100 gallons) to help guard against regulator freeze-ups.

Adjusting the temperature on the gas/electric refrigerator may be a first step. Using less hot water will also help, as well as refraining from using the gas cooktop. A final step is to lower the thermostat setting to reduce gas usage by the furnace.

---

---

## PROPANE VAPORIZATION IN COLD WEATHER

### –If Equipped

Propane gas vaporization increases and decreases in direct relation to ambient temperature. In other words, the lower the temperature, the slower the liquid propane will vaporize into a usable gas for appliances.

This means that in extremely cold weather when a large volume of gas is being used by the furnace for heating, it is possible to experience a loss of gas pressure.

At first, this problem may appear to be caused by an empty tank or a regulator freeze-up, but is actually caused by failure of the liquid gas to vaporize as fast as it is needed by the furnace.

The demand for propane to produce heat increases to the point where the gas cannot vaporize fast enough to keep the furnace going. The only solution to this problem is to reduce gas usage where possible.

## SECTION 6 – ELECTRICAL

---

Your coach is equipped with an electrical system consisting of two separate voltages:

- 12-volt DC system (battery current); and
- 120-volt AC system (household current)

The 12-volt system consists of two internal power sources, while the 120-volt system is operated from an outside power source or the optional 120-volt generator.

---

---

### ELECTRICAL CAUTIONS

- Careless handling of electrical components can be fatal. Never touch or use electrical components or appliances while feet are bare, while hands are wet, or while standing in water or on wet ground.
- Improper grounding of the vehicle can cause personal injury. Do not plug the utility power cord into an outlet which is not grounded and do not adapt the plug to connect to a receptacle for which it is not designed.
- Do not attach an extension cord to the utility power cord.
- Be sure that all electrical appliances to be used contain 3-prong plugs for proper grounding.
- Avoid overloading electrical circuits. Replace fuses or circuit breakers with those of the same size and amperage rating only. Never use a higher rated fuse or breaker.
- Use caution when handling or working near electrical storage batteries. Always remove jewelry and wear protective clothing and eye covering. Avoid creating sparks.

---

---

### ELECTRICAL SYSTEM – HOUSE 120-VOLT AC

The 120-volt system operates from the shoreline cord connected to an outside 120-volt utility service, such as those at campgrounds or from the 120-volt generator. When the shoreline cord is connected to an outside power source, or when the auxiliary electric generator is running,

the power converter automatically changes a portion of the 120-volt current to 12-volt DC current. All equipment in the motorhome that is normally powered by the house batteries is then powered through the converter.

In addition, the following equipment is entirely dependent on 120-volt current: air conditioner, refrigerator, microwave oven, and any 120-volt electrical equipment used at convenience outlets.

---

---

### POWER CORD – EXTERNAL (Shoreline)

The external power cord (commonly referred to as a “shoreline”) is located in the utility compartment or water service center, depending on model.



#### WARNING

Do not use an extension cord. Improper sized cords, damaged cords, and poor connections can lead to fire, which can result in death or serious injury.



#### WARNING

Do not connect the external power cord to any receptacle until you have verified proper polarity and grounding. Be sure all prongs of the supply cord are properly plugged into the receptacle. Failure to observe can result in death or serious injury.

The power cord is designed to ground the electrical system through the receptacle. It is also designed to carry the amperage output of most campground outlets. If the electrical receptacle to

## SECTION 6 – ELECTRICAL

be used is designed to mate with the prongs of the power cord plug, the electrical connection can be expected to carry rated load.

### Connecting The Power Cord

To connect to an external source, remove the cord from the utility compartment and plug it into a suitable 50-amp power receptacle to provide external power to the coach and converter/charger system.

*NOTE: Some parks do not have 50-amp service available, so you will need to connect to a standard 30-amp service pole using an adapter.*

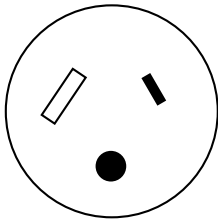

30 Amp Receptacle

### ! WARNING

This connection is for 110/125 Volt AC, 60 Hz 30 Ampere supply. Do not exceed circuit rating. Exceeding the circuit rating may cause a fire and result in death or serious injury.

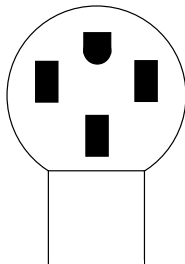

50 Amp.  
Power Receptacle



### WARNING

This connection is for 208Y/120-Volt or 120/240 Volt AC, 3-pole, 4 wire, 60 Hz 50 Ampere supply. Do not exceed circuit rating. Exceeding the circuit rating may cause a fire and result in death or serious injury.

A flip-down hatch lets you route the power cord out the bottom of the compartment so you can close the compartment door while the power cord is connected.

1. Flip the hatch downward.



2. Swivel the cover section aside to reveal cord notch.



3. Route the cord through the notch and flip the hatch back up into place and close the compartment door.



**! WARNING**

Service inlet access must be closed when utility connections are not in use.

### **Park Fuses or Breakers**

Most campgrounds are equipped with a fuse or circuit breaker at the receptacle (which we recommend shutting off before engaging or disengaging the power cord.) This protects the park’s wiring, as well as the power cord on your vehicle from electrical damage. If electrical power fails, contact the park attendants and have them check the fuse or breaker for your supply receptacle.

---

---

### **POWER CORD REEL**

Your coach may be equipped with a 12-volt power cord reel to assist in the retraction of the external power cord (shoreline).



**Power Cord Reel**  
(Located in a driver side compartment)  
-Typical View

### **To Extend the Power Cord**

- Pull out power cord (manually) to a sufficient length and route power cord to an electrical receptacle and plug in.

### **To Retract the Power Cord**

- Detach plug from receptacle using the lever on plug.
- PRESS and HOLD the Power Cord Reel Switch (located near the power cord reel) and the power cord will retract automatically.



**Power Cord Reel Switch**  
(Located near the power cord reel)  
-Typical View

## SECTION 6 – ELECTRICAL

### Further Information

See the manufacturer's user guide provided in your InfoCase for complete features, operating instructions, and precautions.

---

---

### INVERTER/CHARGER UNIT – 2800W (PURE SINE WAVE)

#### –If Equipped

The 2800-watt inverter/charger has an AC input circuit breaker to protect the inverter/charger from overloads. The inverter/charger also has “built in” features that protect the system from abnormal conditions. See the inverter/charger information included in your InfoCase for a complete explanation of the system and operating instructions.

*NOTE: The inverter is not intended for steady use while “dry camping”. Batteries will deplete quickly with use of the inverter. The inverter is intended for limited, short term power usage when not connected to shoreline or generator power. The inverter can also be used while driving the motorhome because the engine alternator will charge the batteries while driving.*

The inverter/charger unit is accessible through a mid-passenger side compartment door.



Inverter Charger Unit  
(Accessible through mid-passenger  
side compartment door)

### NOTICE

Do not store items too closely around the inverter unit in the storage compartment. The inverter generates heat while operating and needs unrestricted airflow for proper cooling. Damage to the inverter can result.

The inverter converts 12-volt DC current from the house batteries into 120-volt AC current for use by 120-volt AC equipment in the motorhome.

### Charging Section

While connected to 120-volt external power, the inverter/charger will recharge the house batteries using a 3-stage battery charger. It will also supply 12-volt DC current for use by 12-volt equipment in the motorhome.

If the house batteries have been significantly discharged, they will accept charge at a relatively high amperage rate. If they are only slightly discharged, they will charge at a lower amperage rate. The rate of charge will decrease as the batteries reach full charge, then will continue “trickle” charging at a very low amperage rate.

The inverter/charger features a Battery Saver™ Mode, which is designed to keep batteries fully charged over long periods of time. See the inverter/charger information included in your InfoCase for more information on this feature.

If the batteries do not charge as described above, it is possible the batteries are defective. If the batteries are extremely discharged, the charger may not be able to recharge the batteries.

*NOTE: Do not leave the shoreline plugged in during storage. Follow regular battery inspection and maintenance.*

### Inverter/Charger Control Panel

The inverter/charger can be programmed for several charging options. It will also display warnings for overload conditions or other operating failure conditions.





**Inverter Status**  
(Located on touch tablet “Home” screen)  
-If Equipped

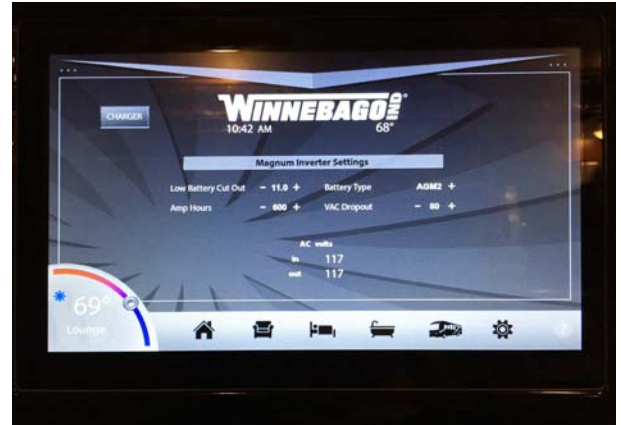

**Inverter Settings Screen**  
(Located on touch tablet)  
-If Equipped



**Touch Tablet Main Menu**  
• Tap on “Utilities” (selection displays in white).



**Inverter Power Switch**  
(Located on touch tablet “Utilities” screen)  
Tap “Inverter” to turn on/off.  
• White text indicates ON.  
• Black text indicates OFF.

Inverter status is shown on the “Home” screen.

Push and Hold “Inverter” to edit the inverter settings.

-If Equipped

When the inverter is not being used, it should be shut off at the control panel. The inverter could drain the house batteries if the shoreline is not connected to external power and the House/Coach Battery Disconnect switch is on.

*NOTE: Your coach may be equipped with a residential-style refrigerator, which will only operate on 120-volt AC. The residential refrigerator requires either the shoreline to be plugged in, the generator running, or inverter power. When the residential refrigerator is operating from inverter power, special care should be taken to ensure adequate power is available from the house batteries and condition of the batteries should be monitored periodically. The inverter is not intended to power devices for long periods of time.*

## Further Information

See the inverter/charger manufacturer’s user guide provided in your InfoCase for complete instructions and charging setup directions.

---



---

## CIRCUIT BREAKERS – HOUSE 120-VOLT AC

The breaker panels protect all 120-volt components in the motorhome from either an overload on the circuit or a short in the wiring or

## SECTION 6 – ELECTRICAL

component itself. When an overload or short develops, the breaker will open preventing damage to the system.

Shut off the equipment (example: roof air conditioner) and allow a brief cooling period. Then reset the breaker by moving the switch to “Off” and back to “On”. If the breaker is continually tripped and no overload is evident, have the system checked for a short in the wiring or the appliances.

The breaker panels are located behind a door or pull-off panel on a lower cabinet face in the galley or lounge area or beneath the rear bed, depending on model.



House Circuit Breakers  
-Typical Installation

*NOTE: Breakers are labeled on panel.  
Arrangement may vary according to  
appliance and equipment options.*

---

---

## ELECTRICAL OUTLETS – HOUSE 120-VOLT AC

A number of standard household electrical outlets are provided throughout the coach for connecting small appliances such as televisions, radios, toasters, etc.

An exterior outlet is also located on the outside of the coach near the entrance door or in a storage compartment on the passenger side of the coach.

---

---

## GROUND FAULT CIRCUIT INTERRUPTER

Bath, galley, and exterior outlets are connected to a GFCI (Ground Fault Circuit Interrupter), which is an extremely sensitive circuit breaker that will help to protect against severe electrical shock if a ground fault develops. If such a condition occurs, the GFCI will break the circuit by turning off the power to the protected outlets. Should this occur, unplug all the appliances on that circuit and press the reset button on the GFCI equipped outlet.

If the GFCI keeps tripping, have the electrical system checked and repaired, if necessary, before using again.

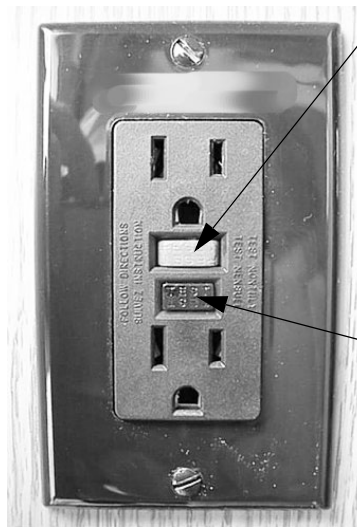

- Push to Reset circuit after monthly testing or ground fault tripping.

- Push to Test at least monthly. Should break circuit. Press Reset button to reconnect.

GFCI Outlet  
(Ground Fault Protector)

 **WARNING**

The GFCI will not completely eliminate the risk of electrical shock. Infants and small children may still be affected.

**ELECTRICAL GENERATOR**

 <b>WARNING</b>
<p>Careless handling of the generator and electrical components can be fatal. Never touch electrical leads or appliances when your hands are wet, or when standing in water or on wet ground. Do not attempt to repair the generator yourself. Service should be performed by a qualified service center.</p>

 <b>WARNING</b>
<p>Do not plug the power cord into the generator receptacle while the generator is running. Electrical shock can cause personal injury.</p>

**Automatic Power Transfer Switch**

Whenever the Generator is started, an Automatic Power Transfer system automatically switches the household electrical system to the Generator approximately 30 seconds after the Generator is started. The 30 second delay allows the Generator to start easily without the burden of electrical loads.





Automatic Power Transfer Box  
(Located inside or behind utility compartment)  
-Typical installation shown

**Automatic Generator Start (AGS)**

The Automatic Generator Start feature monitors house battery voltage and coach interior temperature, and has the ability to automatically start the Generator to help maintain full air conditioning function and house battery charge.

You can manually start and stop the Generator with a touch of a button. The Hourmeter feature registers the total number of hours that the Generator has been operated.

The following label is located near the 120-volt house circuit breaker panel and at the Generator to warn you to disconnect specific electrical connections before servicing the Generator and storing the coach.

 <b>WARNING</b>	
	<p>Auto Genset Starting (AGS) installed.</p>
	<p>Carbon-monoxide (CO), moving parts, and shock can cause severe injury or death.</p>
	<p>Disconnect battery or remote harness at genset to store or garage RV and before servicing genset or RV electrical systems.</p>

## SECTION 6 – ELECTRICAL

### Generator Basic Operation



Generator Switch  
(Located on touch tablet "Utilities" screen)

Tap to turn ON/OFF.

- White text indicates ON.
- Black text indicates OFF.

Push and Hold to edit AGS settings.  
See "Home" screen for Generator Run Hours.  
-If Equipped

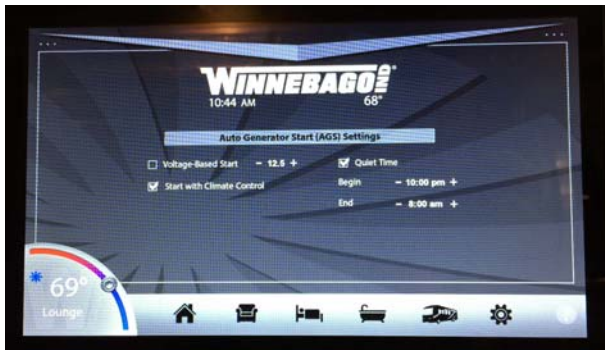

Auto Generator Start (AGS) Settings



Generator Switch

(Located on touch tablet "Home" screen)  
Push and Hold for 10 seconds to turn on.  
• White text indicates ON.

Push and Hold for 3 seconds to turn off.

The button reports the approximate number of total hours the generator has run.  
-If Equipped

### Generator Hourmeter

The Generator Hourmeter is shown on the touch tablet Home screen "Generator Button". It registers the total number of hours that the Generator has been operated.

Refer to the Hourmeter to determine when periodic maintenance is due and to record services which have been performed.

---

## Operation Warnings and Cautions

 <b>WARNING</b>
The exhaust of all internal combustion engines contains carbon monoxide (CO). This poisonous gas is colorless, odorless, tasteless, and lighter than air. The exhaust systems of both your motorhome engine and your generator engine have been installed with your safety in mind. However, certain precautions must be taken when using them to protect yourself from conditions beyond the control of the manufacturer.

- Do not simultaneously operate the Generator and a power vent, which could draw exhaust gases into the vehicle.
- Do not open windows or vents on the end or side of the vehicle where exhaust pipe of the Generator is located.
- Park the vehicle so that the wind will carry the exhaust away from the vehicle. Also, note the position of other vehicles to be sure their exhaust will not enter your vehicle.
- Do not operate the Generator engine while parked if vegetation, snow, buildings, vehicles, or any other object can deflect the exhaust under or into the vehicle.

Check Generator oil level frequently during periods of use. Refer to the Generator manufacturer's user guide provided in your InfoCase for specific recommendations.

### Generator Access

Refer to "Front Service Access - Power Generator Tray" in *Section 3 - Driving Your Motorhome* for further information.

### Further Information

Refer to the Generator manufacturer's user guide provided in your InfoCase for specific operating instructions and cautions, troubleshooting, and maintenance.

---

---

## ELECTRICAL SYSTEM – HOUSE 12-VOLT DC

The DC voltage system consists of the chassis battery, the 12-volt house batteries, and the 12-volt power converter.

### Converter

See "Power Center."

### Chassis Battery

The chassis battery is used to operate the engine starter and automotive accessories and controls found on the instrument panel. The electric step is also connected to the chassis battery.

Refer to your chassis manual provided in your InfoCase for further information on chassis batteries and chassis electrical system.

### House Batteries

House batteries are "deep-cycle" type batteries specially designed for recreational vehicle use. They will provide longer lasting power than standard automotive starting batteries and will withstand the frequent drain-and-recharge cycles that occur under the demanding conditions of a camping outing.

The house batteries supply power to 12-volt equipment located in the living area of the motorhome. This includes the following 12-volt powered components (if equipped): interior 12-volt lighting, range exhaust fan, propane furnace fan, fresh water pump, systems monitor panel, refrigerator, roof vent fans, and 120-volt electrical generator starter.

The house batteries can also provide emergency power to start the engine if the chassis battery is discharged. (See "Battery Boost Switch" in *Section 3 - Driving Your Motorhome*).

House batteries are automatically charged by the chassis alternator while the engine is running.

## SECTION 6 – ELECTRICAL

---

---

### BATTERY INFORMATION

#### Chassis Batteries

The chassis batteries operate the engine starter and all automotive accessories and controls found on the instrument panel. The leveling jacks, slideout room system, and the electric step are also connected to the chassis battery.

The battery Isolation Manager (BIM) monitors the Battery Voltage of both the Chassis and Coach Batteries over long periods of time. If it senses a charging voltage, it connects the two batteries together. If the charging system is overburdened, the batteries will be isolated, however, if the BIM sees a long term charging of both batteries it will allow the batteries to remain connected and allow the charging system to do its job. Once the batteries have reached a Float Charge state for one hour, the BIM will isolate the batteries to prevent overcharging, and will only reconnect the batteries for charging if one of the Battery drops to approximately 80% charge, and the other is being charged. If the batteries are not being charged, BIM isolates the two batteries to prevent an electrical draw in one system from depleting the other battery.

If the house batteries are not being charged, the chassis batteries will be isolated to prevent an electrical draw on the house batteries from depleting the chassis batteries.

#### House Batteries

The house batteries supply current to 12-volt equipment located in the living area of the coach. This includes interior lights, range exhaust fan, water pump, water level and holding tank gauges, 120-volt generator starter, refrigerator, and bath roof vent fan. The house battery may also be used to start the engine if the automotive battery is discharged. (See “House/Coach Battery Disconnect switch” or “Battery Boost switch” in *Section 3 - Driving Your Motorhome*).

The house batteries are automatically charged by the chassis alternator while the engine is running.

*NOTE: House batteries are AGM (Absorbed Glass Mat). Because of their construction, AGM batteries do not require an addition of water to the cells.*

---

---

### HOUSE/COACH BATTERY DISCONNECT SWITCH

The House/Coach Battery Disconnect switch disconnects the house batteries from the 12-volt system of your coach during storage periods to avoid battery drain by electrical items that are hooked directly to the house batteries, such as clock displays and radio memories, etc.

Always leave this switch ON while using the coach.

*NOTE: Some electronic displays and memory functions may need to be reset after power has been reconnected.*

See also “Battery Care” elsewhere in this section.



House/Coach Battery Disconnect Switch  
(Located near entrance door)  
-Typical View

- These switches illuminate when the House/Coach Battery Disconnect switch is ON.

---

---

### BATTERY ACCESS

#### House/Coach Batteries

*NOTE: Your house battery (batteries) are “Absorbed Glass Mat” type, or AGM. They are maintenance-free and do not require checking or adding battery fluid.*

The house/coach batteries are located within the basement of the coach, which is accessible beneath an access cover inside driver and passenger side mid-coach exterior doors.

- Extend sliding tray (if equipped) inside the mid-coach driver and passenger side exterior doors.
- Remove screws from Battery Access Cover.

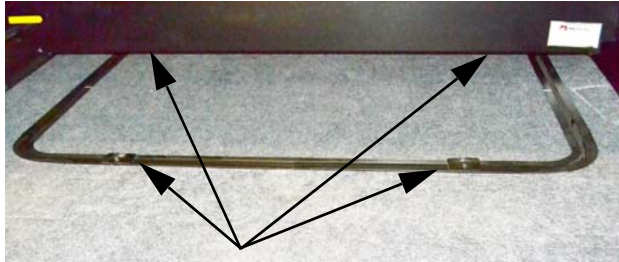

Removable Access Cover  
(Located beneath sliding tray inside the mid-coach driver and passenger side exterior doors)

- Remove Battery Access Cover and set aside.



House/Coach Batteries  
(Shown with access cover removed)  
-Typical View

- Reverse steps to reinstall Battery Access Cover.

### Chassis Batteries

The chassis batteries are located behind a rear passenger side exterior door.



Chassis Batteries  
(Located behind a rear passenger side exterior door)  
-Typical View

### NOTICE

Always refasten battery retainers when returning a battery to the compartment.

### BATTERY CARE

Lead-acid type batteries are electro-chemical devices for storing and releasing electrical charge. As such, they are simply an electrical reservoir, not an electrical source. As soon as energy is removed from the battery, it should be replaced by the engine alternator or the coach converter system.

If a battery sits unused for 30 days or more, especially during warm weather, it can develop a deposit of sulfate crystals on the metal plates inside the battery. This condition is called “sulfating” and prevents the battery from either releasing or accepting a charge. If this condition occurs, the battery must be replaced.

If a battery does not contain at least 80% charge during freezing temperatures, the electrolyte can freeze and crack the battery case.

## SECTION 6 – ELECTRICAL

### The two best defenses against sulfating and insufficient charge are to:

1. Turn off the House/Coach Battery Disconnect switch to avoid parasitic discharge (the trickle discharge caused by directly connected components like propane gas detectors or digital clock displays, etc.)
2. Check the battery and recharge as necessary at least once a month during long storage periods. Turn the House/Coach Battery Disconnect switch off to avoid electrical arcing when attaching or detaching charger clamps.

### NOTICE

Disconnect batteries before connecting external charging equipment to avoid damage to sensitive electronic components.



### WARNING

This vehicle, like other vehicles, may contain small amounts of one or more substances which are listed by the state of California for causing cancer or reproductive toxicity.



### WARNING

**California Proposition 65 Warning:** Battery posts, terminals, and related accessories contain lead and lead compounds, chemicals known to the state of California to cause cancer and reproductive harm. Wash hands after handling.

### Further precautions are:

- Check the state of charge periodically to avoid discharge or sulfating.

To ensure that the battery will always accept and hold a charge, follow these simple maintenance practices:

- Make sure the batteries always remain securely clamped in the battery tray.
- Make sure battery cable clamps are tight on the terminal posts and are free of corrosion.
- Neutralize corrosion buildup or acid film on top of battery by washing with a baking soda/water solution. Rinse with clear water.

*NOTE: Make sure vent caps are on securely to prevent baking soda solution from entering the battery and contaminating the electrolyte fluid.*



### WARNING

Before removing any battery cables or battery, make sure all 12-volt equipment in the motorhome is off and the power cord has been disconnected. Be sure to replace the battery terminal boot, if supplied, back onto the positive terminal after servicing. Care must be taken to avoid pinching the cable between any metal parts. Should the cable be damaged, a short circuit could result in personal injury or damage to equipment. Replace any damaged cables at once. Always remove jewelry and wear protective clothing and eye covering when checking or handling batteries.

- Clean and tighten battery terminals and have the specific gravity checked at least once a year.

*NOTE: Do not leave the shoreline plugged in during storage. Follow regular battery inspection and maintenance.*



**! WARNING**

To prevent wiring damage, it is essential when replacing the cables on the battery, or when using a “booster” battery, that the positive post and the positive cable be attached and the negative post and negative cable be attached. The posts are marked (+) plus and (-) minus.

If a “boost charger” is used while battery is in the motorhome, disconnect both battery cables before connecting the charger to avoid damage to engine electronic components.

Never attempt to charge or boost a frozen battery. An explosion can occur resulting in personal injury.



House Circuit Breakers  
-Typical View

### **Chassis Batteries**

If your coach is going to be unoccupied for two weeks or more, Winnebago Industries® recommends disconnecting the chassis batteries in your coach to avoid battery discharge.

Turn the Chassis Battery Disconnect switch (located near the entrance door) to the OFF position to disconnect batteries.

*Typical view of breaker panel. Actual breaker panel location may vary according to model floorplan. Breakers are labeled on panel according to appliance and equipment options.*

---

### **CIRCUIT BREAKERS – HOUSE 12-VOLT**

All 12-volt circuits and equipment in the coach area of the motorhome are protected by the breaker panel. When a circuit is overloaded or a short develops in any part of the system, a fuse or breaker will shut down that circuit. If this happens, turn off all affected lights or appliances and press the breaker in to reset.

The House 12-Volt Breaker Panel is located behind a cabinet door in the bedroom or rear bathroom, depending on model.

A label on the panel states the amperage rating and circuit protected for each breaker.



# SECTION 7 – PLUMBING

---

---

---

## FRESH WATER SYSTEM

The Fresh Water System provides water to the galley sink, shower, bathroom lavatory, and toilet. Water may be supplied by either of two sources:

- A fresh water tank and water pump located within the motorhome, or
- Any external fresh water source to which the motorhome may be connected, known as “city water”.

There are two ways to fill the fresh water tank on your coach - City Fill or Gravity Fill.

### Water Pressure Regulators

Because city water pressure varies from location to location, we recommend obtaining an in-line water pressure regulator to prevent damage to any components, connections, and seals in your fresh water system.

These devices simply connect in-line between the supply hose and the city water input on the coach. We recommend regulators that control water pressure to **50 psi. max.**

Water pressure regulators are commonly available at most RV dealerships and many large retail discount or home supply centers.

### Method 1 - Filling the Fresh Water Tank Through City Fill Connection

Always fill the fresh water tank at an approved potable water filling facility or a known purified drinking water source.

The tank is filled through the City Water Connection (Fresh Water Inlet) located inside the water service center.

The Fresh Water valve (located in the water service center) routes the water from the city water hose to the fresh water tank for filling.

1. Attach hose from a city water faucet to the Fresh Water Inlet or pull a sufficient amount of hose from the Water Hose Reel (located in the water service center) and attach to an external city water faucet.



Fresh (City) Water Connection  
“Fresh Water Inlet”  
(Located in the water service center)  
-Typical View

 <b>WARNING</b>
Potable water only. Sanitize, flush, and drain water tank before using. See owner’s manual for instructions, care, and maintenance information. Failure to maintain tank can result in death or serious injury.

## SECTION 7 – PLUMBING

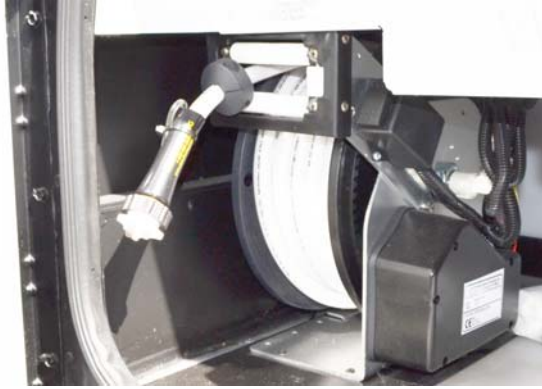

Water Hose Reel  
(Located in the water service center)  
-Typical installation shown

2. Turn the Fresh Water valve to the Tank Fill position.



Fresh Water Valve  
(Located in water service center)  
-Typical View

3. Turn city water supply ON.
4. Use the level display on the exterior monitor panel to oversee filling of the tank, or when the tank is full, water will flow from tank vent tube beneath coach.

### NOTICE

Do not leave fresh water connection unattended when filling tank. Failure to comply may result in tank expansion and property damage.

5. Turn OFF city water supply and disconnect from the Fresh Water Inlet.
6. Turn Fresh Water valve to Normal position to use the water pump.

*NOTE: The Tank Fill position is only for pressure filling the water tank from the city water hose connection.*



Fresh Water Valve  
(Located in water service center)  
-Typical View

### Using City Water

When connected to an outside source of water, the water bypasses the water pump and storage tank and supplies pressure directly to individual faucets and toilet(s). A check valve built into the pump prevents water from entering the pump and filling the storage tank.

- Connect hose to Fresh Water Inlet as described in previous steps.
- With the Fresh Water valve in the Normal position, turn the Water Pump switch(es) OFF.

*NOTE: Always keep the Fresh Water valve in Normal position unless you are filling the tank. If this valve is left in the Tank Fill position while using the city water, water will keep flowing into the tank and out the tank vent tube onto the ground and the water pump will run without delivering water to faucets.*

### Disconnecting from City Water

- Turn the city water supply OFF.

- Open a faucet on the coach (such as exterior wash station) to relieve waterline pressure.
- Disconnect hose from the coach and replace cap on the Fresh Water Inlet (or retract the hose into the hose reel). Be sure to replace the protective cap on the hose end to avoid entrance by debris or insects.

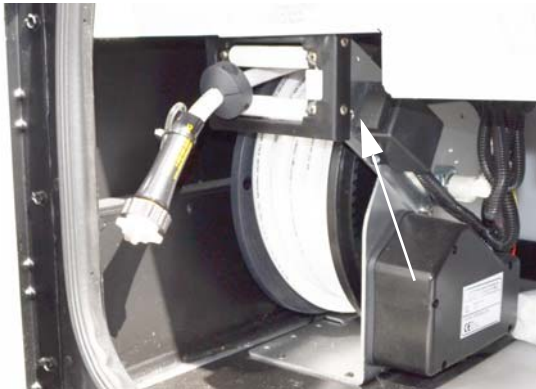

**Water Hose Reel  
- Typical View**

- Press and Hold Water Hose Reel switch to retract

*NOTE: Ensure the Fresh Water valve is in Normal position to use the water pump. If the valve is in Tank Fill position, the pump will run continuously without delivering water.*

## **Method 2 - Filling the Fresh Water Tank Through Gravity Fill**

 <b>WARNING</b>
Potable water only. Sanitize, flush, and drain water tank before using. See owner's manual for instructions, care, and maintenance information. Failure to maintain tank can result in death or serious injury.

Always fill the fresh water tank at an approved potable water filling facility or known purified drinking water source.

The gravity tank fill port is located in the third passenger side compartment.

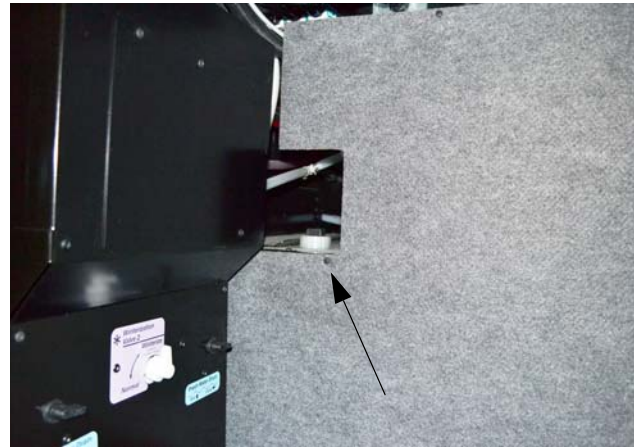

**Gravity Fill Port  
(Located in the third passenger side compartment)**

- Insert hose into fill port and turn water supply on.

*NOTE: Be careful not to overfill the tank.*

### **Using Tank Water (Gravity Fill)**

- Turn Water pump switch ON. While the switch is on, the water pump will automatically supply tank water as needed.

---

## **WATER PUMP**

When your coach is not connected to a city water supply, water is supplied from the fresh water tank by a water system demand pump. A demand pump is designed to run only when you are using water. When you open a faucet, the waterline pressure drops and the pump begins to run, and it will continue to run as long as the faucet is open. When you close the faucet, the line pressure backs up to the pump, and it shuts itself off.

The pump is self-priming and will run briefly to build up line pressure when the Water Pump switch is first turned on. See “Initial Waterline Priming” for instructions on using the water system for the first time.

## SECTION 7 – PLUMBING

### Water Pump Strainer

The pump is equipped with a cleanable strainer to capture any possible tank-borne particles that could damage pump components.

*NOTE: We recommend that you check and clean the strainer after each tankful of water during the first few uses of the Water Pump system. Thereafter, remember to check it at least yearly, and be sure to empty water from it if using the blowout winterization procedure.*



Water Pump Strainer  
-Typical View

### To Clean Pump Strainer

- Ensure all Water Pump switches are OFF.
- Twist the inlet cap (bowl) “counter-clockwise” to unscrew from the strainer assembly.
- Remove the bowl and pull the strainer screen out of the bowl to tap out any particles and rinse clean.
- Insert the strainer screen back into the bowl, then screw the bowl back onto the strainer assembly.

### Water Pump Switch

The Water Pump switch is located near the monitor panel (some models may have an additional switch in the water service center, near the exterior shower, or within the bathroom area for your convenience).

While the switch is “ON”, the pump will automatically supply water as it is needed.

We recommend that you turn the Water Pump switch off whenever you will be away from the vehicle or not using the water system. In time, a slow leak in a faucet could drain the water tank, fill the holding tank, and discharge the house batteries.

### Initial Waterline Priming

1. Ensure that all water drain valves are closed, including water heater valve.
2. Turn Water Pump switch to “OFF” position.
3. Fill water tank.
4. Open all faucets, hot and cold.
5. Turn ON the Water Pump switch.
6. Close each faucet as it begins to deliver a steady stream of water (close cold water first). Leave hot water faucets on until they also deliver a steady stream of water. This will ensure that the water heater is filled with water.
7. Check to ensure the Water Pump stops soon after all faucets have been closed.
8. The Water Pump is now ready for automatic operation. The pump will start when a faucet is opened and stop when the faucet is closed.

### Further Information

Refer to the Water Pump manufacturer’s operation, care, and maintenance information provided in your InfoCase.

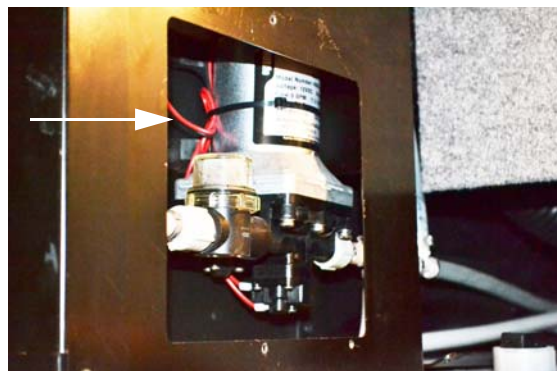

Water Pump  
(Located in the third passenger side compartment. Remove panel to access.)  
-Typical View



**Water Pump Switch**  
(Located on exterior water service center)  
-If Equipped  
*The switch will illuminate blue when the switch is on. White illumination indicates the switch is off.*



**Water Pump Switch**  
(Located in all bath areas)  
-Typical View  
*The switch will illuminate blue when the switch is on. White illumination indicates the switch is off.*



**Touch Tablet Main Menu**  
• Tap on "Bath" (selection displays in white).

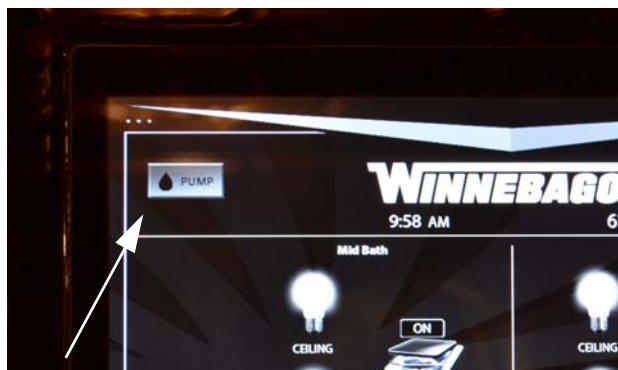

**Water Pump Switch**  
(Located on touch tablet "Bath" screen)  
-If Equipped  
Tap to turn Water Pump ON/OFF.  
• White text indicates ON  
• Black text indicates OFF

---



---

## COLD WATER FILTER

### -If Equipped

To obtain filtered cold water for drinking or cooking, simply open the galley sink cold water faucet.

*NOTE: Only the galley cold water faucet is filtered.*

The cold waterline flows through an activated carbon filter that removes chlorine and odors for taste-free drinking water.



**Cold Water Filter Assembly**  
(Located below galley sink)  
*NOTE: Hot waterline is not filtered.*

## SECTION 7 – PLUMBING

### Replacing the Cold Water Filter Cartridge

You should replace the filter cartridge every season and when water flow from the faucet is too slow for convenience. The cartridge must be replaced at least every 12 months.

#### Further Information

See the water filter manufacturer's operation information in your InfoCase for filter cartridge replacement.

---

---

### COLD WATER FILTER

#### –If Equipped

To obtain filtered cold water for drinking or cooking, simply open the galley sink cold water faucet.

*NOTE: Only the galley cold water faucet is filtered.*

The cold waterline flows through an activated carbon filter that removes chlorine and odors for taste-free drinking water.



Cold Water Filter Assembly  
(Located below galley sink)

*NOTE: Hot waterline is not filtered.*

### Replacing the Cold Water Filter Cartridge

You should replace the filter cartridge every season and when water flow from the faucet is too slow for convenience. The cartridge must be replaced at least every 12 months.

- Place a container beneath the filter to catch any water remaining in the waterlines during filter removal.
- Twist the filter cartridge “counter-clockwise” about one-quarter turn, then pull it down and out of the filter socket.
- Insert a new water filter cartridge up into the filter socket as far as possible and twist it “clockwise” one-quarter turn until it stops.



- Insert new filter up into filter socket - press and twist 1/4 turn “clockwise”.
- Before using the water for drinking, run a few gallons of water through the filter and discard water to avoid consuming carbon dust or particles that may have been present in the new filter cartridge.

#### Diverter Plug

- Install the diverter plug into the filter socket for winterization or if water must be used while the filter is removed from the socket. The diverter plug is installed in the same manner as the water filter.



Diverter Plug (installed in filter socket)

- Insert and twist 1/4 turn “clockwise”.



- See “Winterization Procedure” at the end of this section for further information.
- When removing the coach from storage, always disinfect and flush the water system thoroughly before installing a new filter. See “Disinfecting Your Fresh Water System” elsewhere in this section for more information.

*NOTE: After the system has been thoroughly flushed, remove the diverter plug and store for future use.*

---

---

## ICE MAKER WATER FILTER

### –If Equipped

If the refrigerator in your coach is equipped with an ice maker, an ice maker filter is provided, which removes chlorine and odors for clean, taste-free ice cubes.



Galley Cold Water Faucet/Ice Maker Filter Assembly  
(Located below galley sink)

### Replacing the Ice Maker Filter Cartridge

The filter cartridge must be replaced at least every 12 months, or when water flow from the filtered water faucet is too slow for convenience.

- Place a container beneath the filter to catch any water remaining in the waterlines during filter removal.

- Twist the filter cartridge counter-clockwise (to the left) about one-quarter turn, then pull it down and out of the filter socket. (A spring-loaded valve inside the filter socket will block water from flowing out of the socket when the filter cartridge is removed).
- Insert a new filter cartridge up into the filter socket as far as possible and twist it clockwise (to the right) one-quarter turn until it stops.
- Discard the first two batches of ice cubes to avoid consuming carbon dust or particles that may have been present in the new filter cartridge.
- See “Winterization Procedure” at the end of this section for further information.

*NOTE: When removing the coach from storage, always disinfect and flush the water system thoroughly before installing a new filter.*

---

---

## FULL-COACH WATER FILTRATION SYSTEM

### –If Equipped

The full-coach water filtration system is connected to the cold water lines throughout the coach. It uses a flow-through filter that removes chlorine, cloudiness, and sediments, resulting in clear, odorless and taste-free clean water for drinking, cooking, and personal care.



Full-Coach Water Filter System  
(Located in water service center)  
-Typical View

## SECTION 7 – PLUMBING

### Replacing the Full-Coach Water Filtration Cartridge

Replace the filter cartridge after 1,000 gallons of usage or sooner if water flow from faucets is noticeably reduced.

- Turn off the water supply and relieve water line pressure by opening a faucet.
- Remove the filter canister from the filter head. Use the filter wrench supplied to loosen the filter canister.



- Unscrew the canister from the filter head. (There will be water inside the canister).
- Remove the large O-ring seal from the canister. Check seal for damage, wipe clean, and set aside. Discard the used filter cartridge.
- Wash the inside of the canister with dish soap and warm water using a nonabrasive sponge or cloth. Rinse thoroughly.
- Fill canister about 1/3 with clean water and add a couple of tablespoons of household bleach, then scrub with a sponge or brush to disinfect. Rinse thoroughly.

- Lubricate the O-ring with clean silicone grease to ensure a proper watertight seal, then place back into the groove at the bottom of the canister threads.

*NOTE: The O-ring should be replaced every third cartridge change to ensure proper sealing. See your dealer for replacement cartridges and O-rings.*

- Insert a new filter cartridge into the canister, then hand tighten the canister securely onto the filter head. **DO NOT OVER-TIGHTEN.**
- Turn the Fresh Water Valve to Normal position. Next open a faucet inside the coach or the exterior shower, then turn city water on **SLOWLY** to allow the canister to fill with water.
- Thoroughly flush the filtration system by running the water for twenty (20) minutes.
- Check for leaks.

See “Winterizing Procedure” in this section to prepare the water filtration system for freezing conditions.

---

---

### DISINFECTING YOUR FRESH WATER SYSTEM

**(As required by NFPA®1192 Standard on Recreational Vehicles)**

**–For coaches with Full-Coach Water Filtration System**

To ensure complete disinfection of the potable water system, it is recommended that the following procedure be followed on a new system, one that has not been used for a period of time, or one that could have become contaminated.

This procedure is also recommended before long periods of storage such as over winter.

#### **Disinfecting with Gravity Fill –If Equipped**

1. Prepare a chlorine solution using 1 gallon of water and 1/4 cup of household chlorine bleach (sodium hypochlorite solution). With tank empty, pour chlorine solution into the tank through the gravity fill port.

Use 1 gallon solution for each 15 gallons of tank capacity. This procedure will result in a residual chlorine concentration of 50 ppm in the water system.

*NOTE: If a 100 ppm concentration is desired, use 1/2 cup of household bleach with 1 gallon of water to prepare the chlorine solution. One gallon of this solution should be used for each 15 gallons of tank capacity.*

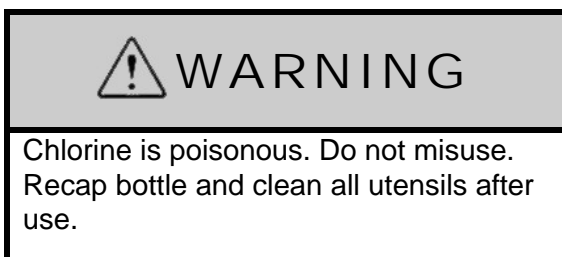

2. Complete filling of tank with fresh water.
3. Open each faucet in the coach and run the water until a distinct odor of chlorine can be detected in the water discharged. Do not forget the hot water faucets.
4. Let the system stand at least 4 hours when disinfecting with 50 ppm residual chlorine. *If a shorter time period is desired, then a 100 ppm chlorine concentration should be allowed to stand in the system for at least 1 hour.*
5. Drain the water tank and refill with fresh water.
6. Open each faucet again and run fresh water to flush chlorinated water from the lines. Run the water until there is no odor of chlorine detected in the water discharged. Do not forget the hot water faucets. *(You may need to leave a hot water faucet open for some time to flush the water heater (if equipped) with clean water. You may also want to turn the water heater off until this is done to avoid wasting energy trying to heat “unused” water).*
7. Water system is now disinfected.

## City Water Tank and Hose Disinfection

This procedure can be used periodically to sanitize the city water hose, and can be used as an alternate method of adding bleach solution to the fresh water tank if desired.

1. Connect a water hose to the Fresh Water Inlet (located in the water service center).
2. Turn the Fresh Water valve to the Tank Fill position.
3. Remove the Full-Coach Water Filtration cartridge from the filter canister. Refit empty canister to filter head for procedure.
4. Hold the “city end” of the water hose upright and use a funnel to pour 1 1/2 cups of household chlorine bleach (sodium hypochlorite solution) into the hose. Keep the end of the hose held upright to avoid draining the bleach solution.
5. Connect the hose to a city water source and turn on slowly, allowing the water to force the bleach through the hose, then continue filling the tank with water. (This will disinfect the city water hose at the same time).
6. Let the system stand at least 4 hours when disinfecting with 50 ppm residual chlorine. *If a shorter time period is desired, then a 100 ppm chlorine concentration should be allowed to stand in the system for at least 1 hour.*
7. Drain the chlorinated water from the fresh water tank and refill with clean water.

## Continuous Tank Disinfection (Superchlorination)

Some RVers like to ensure continuous sanitation of their fresh water tank by “superchlorination”—maintaining an effective low level of chlorine in the tank at all times.

- Add 1 teaspoon of chlorine bleach (sodium hypochlorite) to your tank for each 10 gallons of tank capacity. When you fill the tank, this will result in a 6.7 ppm level of chlorine, which should kill harmful bacteria and slime-forming organisms.

## SECTION 7 – PLUMBING

---

- Chlorine will be removed from drinking water by the Full-Coach Water Filtration System.
- Superchlorination does not affect city water usage, only the fresh water tank.

---

### SHOWER HOSE VACUUM BREAKER

After using the shower, you may notice water dripping from the shower faucet assembly. The dripping results when vacuum in the shower hose (after closing the shower faucet) slowly releases and allows water remaining in the hose to drain down. This is a normal function of the shower valve assembly and is not a leak or defect.

If items are placed into the shower tub before shower valve vacuum release is complete, they may become wet.

---

### EXTERIOR SHOWER/WASH STATION

#### –If Equipped

The Exterior Shower/Wash Station feature allows you to do things such as rinse off sand or salt after a swim, rinse off muddy boots, or bathe your pet outside the coach. Some models may have a Water Pump switch located near the shower faucet for convenience.



Exterior Shower/Wash Station  
-Typical View

---

### TOILET

#### –If Equipped

The toilet in your motorhome is very similar to the household type, except that it is designed to use only a small amount of water per flush. It uses a high velocity jet of water, producing a swirl effect, to efficiently cleanse the bowl.

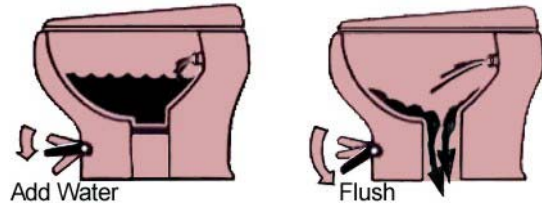

#### Important “Don’ts”

- Don't use facial tissue or regular toilet tissue in the RV toilet. These will not disintegrate sufficiently and will often cling to the sides of the holding tank. Toilet tissue made specifically for use in RV toilets and holding tanks is available at most RV supply centers.
- Don't dispose of sanitary napkins or other non-dissolving items in the toilet.
- Don't put automotive antifreeze or caustic chemicals, such as laundry bleach or heavy detergents into the toilet or holding tank. These products may damage plastic or rubber parts in the system.

See winterizing instructions at the end of this section to prepare the toilet for storage in freezing conditions.

#### Further Information

See the toilet manufacturer's operation information in your InfoCase for complete operating, care, and maintenance information.

---

### TOILET – ELECTRIC FLUSH

#### –If Equipped

Your coach may be equipped with an electric macerating toilet, which provides powerful, yet whisper quiet operation. It is equipped with a wall-mounted push button control and operates on minimal water consumption.

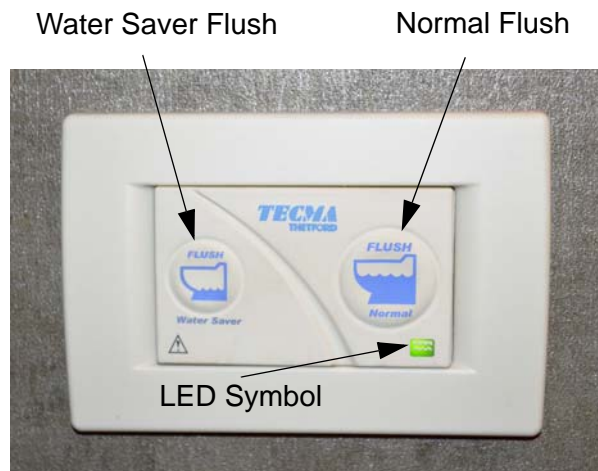

Wall Switch/Controller  
(Located on wall near toilet)

### Water Saver Flush Button

- Press and release to flush liquids and small amounts of toilet paper.

### Normal Flush Button

- Press and release to flush solids and toilet paper.

### LED Symbol

- Symbol not lighted - Toilet is OFF, in sleep mode, or not receiving power.
- Symbol lighted GREEN - Toilet is ON and the holding tank is between empty and half full.
- Symbol lighted YELLOW - Toilet is ON and the holding tank is at least half full.
- Symbol lighted RED - Toilet system is ON and the holding tank is full.

### Important “Don’ts”

- Don’t use facial tissue or regular toilet tissue in the RV toilet. These will not disintegrate sufficiently and will often cling to the sides of the holding tank. Toilet tissue made specifically for use in RV toilets and holding tanks is available at most RV supply centers.
- Don’t dispose of sanitary napkins or other non-dissolving items in the toilet.
- Don’t put automotive antifreeze or caustic chemicals, such as laundry bleach or heavy detergents into the toilet or holding tank. These products may damage plastic or rubber parts in the system.

See winterizing instructions at the end of this section to prepare the toilet for storage in freezing conditions.

### Further Information

See the toilet manufacturer’s operation information provided in your InfoCase for complete operating, care, and maintenance information.

---

---

## DRAINAGE SYSTEM (P-TRAPS)

Ensure there is an adequate amount of water in the drainage system p-traps to avoid sewer odor from entering your coach.

If you should experience a sewer odor, pour approximately 1 cup of water down each sink and shower drain in the coach.

### Washer/Dryer

#### –If Equipped

In addition to pouring water down sink and shower drains, also run a wash cycle to ensure there is an adequate amount of water in the washer p-trap.

---

---

## WASTE WATER SYSTEM (Holding Tanks)

The drainage system is self-contained and uses two separate holding tanks (or three, depending on model) to contain the waste water until it can be dumped at an appropriate waste water disposal site. This means you can use the toilet, sinks, and shower even in areas where utility hookups are not available.

The black water holding tank contains the sewage from the toilet(s) and may include bathroom lavatory on some models. The gray water holding tank(s) contain the waste water from the galley sink and shower, and may include bathroom lavatory.

See “Specifications” in *Section 1 - Introduction* for tank capacities for your model.

## SECTION 7 – PLUMBING

### Dumping Holding Tanks

The sewage drain hose (located in the water service center) features a convenient handle and valve nozzle for sanitary handling and improved waste disposal.

1. Remove the dust cap from the sewage drain outlet and connect the sewage drain hose. Be sure it is firmly attached.

*NOTE: The sewage drain outlet swivels downward when necessary to avoid bends in the sewage drain hose, which could trap solids while dumping or to provide more direct drainage while using on-site sewer hook-ups.*

2. Push the handle forward to open the sewage drain hose end valve, then extend the hose and place the nozzle into the disposal opening.



*NOTE: The sewage drain hose end valve (handle) must be opened before pulling the hose to the disposal opening. If the valve is closed, a vacuum will develop and prevent the hose from expanding fully.*

*Do not open holding tank waste valves until the sewage drain hose end valve is*

*open. If you open the dump valve before the hose valve, the hose will fill with sewage water and become difficult to move or could become clogged.*

3. Open the Black Waste Tank Drain Valve with a quick pull. Move the sewage drain hose gently about to dislodge any waste and to ensure complete drainage. Close the Black Waste Tank Drain Valve as soon as the tank is empty.

*NOTE: DO NOT OPEN BOTH VALVES AT ONCE. Do not open the Gray Waste Tank Drain Valve(s) until the black tank is drained and Black Waste Tank Drain Valve closed to avoid sewage back-up into gray tank(s). Gray water also rinses any black water solids from the sewage drain hose.*

### Model 42QL



Black and Gray Waste Tank Drain Valves  
(Located in water service center)

**Model 42HL and 45RL**



Black Waste Tank Drain Valve      Gray Waste Tank Drain Valve #1      Gray Waste Tank Drain Valve #2

Black and Gray Waste Tank Drain Valves  
(Located in water service center)

*NOTE: Black and Gray Waste Tank Drain Valve positions may be reversed depending on floorplan and tank location.*

4. Open the Gray Waste Tank Drain Valve with a quick pull. Close Gray Waste Tank Drain Valve as soon as tank is empty.  
**Models 42HL and 45RL are featured with two gray waste tanks. Therefore, two Gray Waste Tank Drain Valves must be opened.**
5. After waste tanks have been drained, flush the black water tank as described in “Flushing Your Black Water Holding Tank” following this procedure. (If hose is not available, run several gallons of water into the sewage tank through the toilet. Then open the Black Waste Tank Drain Valve and drain the tank again. Close Black Waste Tank Drain Valve when done).
6. Close sewage drain hose valve by pulling handle up until lock snaps into place.
7. Rinse end of sewage drain hose thoroughly with water and stow.



*NOTE: If the sewage drain hose will not collapse while storing, open the sewage drain hose end valve (handle) to release air trapped inside the hose.*

8. Add an odor control chemical to the black waste holding tank through the toilet. These chemicals are available at most RV stores.

*NOTE: We recommend that you dump all holding tanks before traveling to avoid carrying unnecessary weight.*

**Flushing Your Black Waste Holding Tank**

The black waste holding tank is equipped with an internal spray head that allows you to rinse the inside of the tank with a shower of clean water after dumping.

 **CAUTION**

Do not use the tank flush valve unless the fullway termination valve is in the open position. May result in an unsanitary condition leading to illness or personal injury.

1. Dump your black waste holding tank in the usual manner at an approved sewage disposal station.
2. Leave Black Waste Tank Drain Valve open while flushing tank.

## SECTION 7 – PLUMBING

---

3. Attach a garden hose from a city water hydrant to the Black Waste Tank Flush Inlet fitting in the water service center. (This inlet is clearly marked separate from the City Water inlet).



Black Waste Tank Flush Inlet  
(Located in water service center)  
-Typical View

4. Turn the water on to begin flushing. Allow water to run for about three minutes.
5. Disconnect garden hose from flushing system and close Black Waste Tank Drain Valve.

### Using On-Site Sewer Hook-Ups

The sewage drain hose may remain attached to the sewage drain outlet and be routed out the flip-down hatch in the bottom of the compartment while the motorhome is parked and connected to an on-site sewage hook-up.

*The center outlet section may be swiveled downward for better hose alignment and drainage.*



When using a sewer hook-up, keep the Black and Gray Waste Tank Drain Valves closed until a tank becomes full or when preparing to leave

the site. This keeps the solids in suspension, allowing them to be carried out with the liquids when the dump valve is opened.

If the valve is left open, the liquids will drain off, leaving solids in the tank. Should this accidentally happen, disconnect the sewage drain hose, fill the tank about half full with water, and drive a few miles to dislodge the solids. A few starts and stops will aid in the process. Then reconnect the sewage drain hose and drain in the normal manner.

*NOTE: Always keep sewage drain outlet capped while sewage connection is not in use.*

### Holding Tank Level Indicators

See “Systems Monitor Panel” in *Section 4 - Appliances* for further information on the monitor panel and checking tank levels.

See “Specifications” in *Section 1 - Introduction* for tank capacities for your model.

---

---

### UTILITY LIGHT

A light is located on the sidewall to illuminate the utility hook-up area when needed.

The switch is located in the water service center compartment or on the touch tablet (if equipped).

*NOTE: The exterior security switch will also turn this light on along with the porch light.*





(Located in water service center)  
- Typical View

The switch will illuminate blue when the switch is on. White illumination indicates the switch is off.



Touch Tablet Main Menu

- Tap on “Exterior” (selection displays in white).



(Located on touch tablet “Exterior” screen)  
-If Equipped

## WATERLINE AND TANK DRAIN VALVES

The waterline and tank drain valves are used to drain water from the water tank and the water supply lines when preparing the motorhome for storage or when sanitizing the water system.

See the “Water System Drain Valve Locations” chart at the end of this section for locations on your model.

### Waterline Drain Valves



Waterline Drain Valves  
(Located in the third passenger side compartment)  
-Typical View

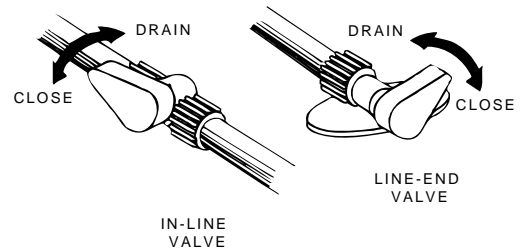

Waterline Drain Valves  
-Typical View

## SECTION 7 – PLUMBING

### Water Tank Drain Valve



Water Tank Drain Valve  
(Located in the third passenger side  
compartment)  
-Typical View

The system features a Winterization (diverter) valve with an antifreeze siphon tube to draw non-toxic RV water system antifreeze into the waterlines. This feature is located near the water pump.

### WARNING

NEVER use automotive antifreeze/coolant in your RV water system. Auto antifreeze contains ethylene glycol which, if ingested, can cause blindness and can be fatal.

### Remove Water Filters (if equipped)

#### 1a. If Equipped with 3M Cold Water Filter:

Remove and discard the filter cartridge from the filtered cold water faucet/ice maker filter assembly located below the galley sink.



Filtered Cold Water/  
Ice Maker Filter  
(Located below galley sink)

---

---

## WINTERIZING PROCEDURE

### NOTICE

Do not blow out Aqua-Hot Hydronic Heating System. Failure to comply may result in system damage.

### Antifreeze Fill Procedure

(Fill plumbing lines with RV water system antifreeze)

*NOTE: Winterize tanks and waterlines by filling them with non-toxic RV water system antifreeze through the plumbing system. This product is available from your dealer and from most RV supply stores and national retail outlets. Follow directions on the container to determine the correct amount to use for your coach.*

Your coach is equipped with a manually operated waterline winterization system for your convenience in winterizing fresh waterlines.

- Place a container beneath the filter to catch any water remaining in the waterlines during filter removal.
- Twist the filter cartridge “counter-clockwise” about a quarter-turn and pull it down and out of the filter socket.
- Install the diverter plug into the filter socket as far as possible and twist “clockwise” one-quarter turn until it stops.

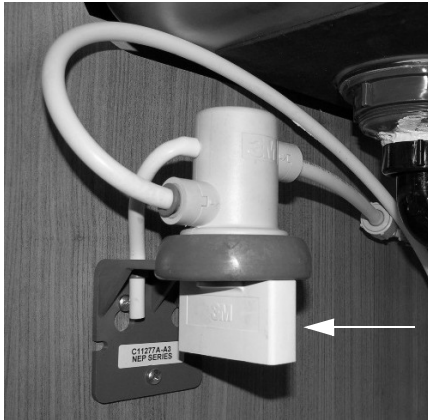

**Diverter Plug**

**1b. If Equipped with Culligan Cold Water**

**Filter:** Remove the filter canister from the Cold Water Filtration System under the galley sink and discard the filter cartridge. After emptying the canister, remount it onto the filter assembly and continue the Antifreeze Fill Procedure.



2. Remove the filter canister from the Full-Coach Water Filtration system in the water service center and discard the filter cartridge. After removing filter, remount the empty canister onto the filter assembly and continue the antifreeze fill procedure.
3. Turn Winterization Valve 2 to the “Winterize” position.



**Winterization Valve 2**  
(Located near water pump - second compartment on driver side of coach)

4. Remove and save the protective cap from the end of the antifreeze siphon tube (which connects to Winterization Valve 2). Insert the end of the siphon tube into a pail or other container with 2 to 5 gallons of non-toxic RV antifreeze solution.

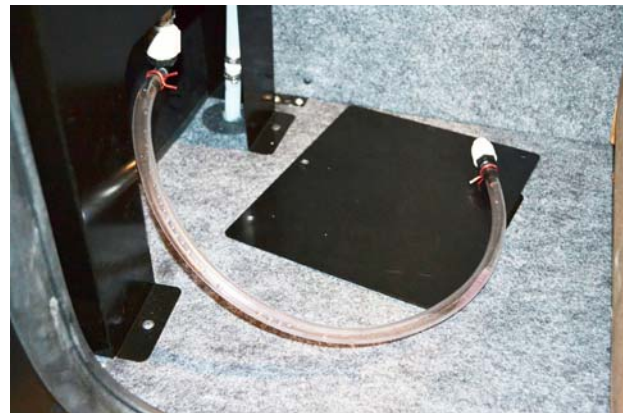

**RV Antifreeze Siphon Tube**  
(Located in the third compartment on passenger side of coach)

- Insert into container of RV water system antifreeze

*NOTE: Ensure that all drain valves are CLOSED before pumping RV antifreeze into the water system. Refer to the “Water System Drain Valve Locations” chart at the end of this section for valve locations on your model.*

## SECTION 7 – PLUMBING

---

### Fill Lines

5. Turn the Water Pump switch ON.
6. Open each hot and cold water faucet handle/knob in the coach – one at a time each in turn until antifreeze solution just begins to flow from the faucet, then close.  
Do not forget exterior shower/wash station knobs.
7. Press the toilet flush pedal (or the “Normal Flush” button on the wall control, if your coach is equipped with an electric flush toilet) and hold until antifreeze begins flowing into the toilet.  
Leave small amount of antifreeze that remains in the bowl.

### When Done Adding RV Antifreeze

8. Turn the Water Pump switch OFF.
9. Turn the Winterization Valve 2 to “Normal”.  
This will stop the flow from the antifreeze siphon tube and revert the tank line flow to the water pump.
10. Replace the protective cap onto the end of the antifreeze siphon tube to keep out insects and debris when not in use.

### Drain Appliances

11. At this time, if your coach is equipped with a refrigerator ice maker, dishwasher, or washer/dryer, the waterlines for these appliances must also be drained. (See “Winterizing Optional Appliances” at the end of this section).

### Fill Drainage System P-Traps

12. Pour about one cup of RV antifreeze down each drain for the galley sink, lavatory sink, and shower/tub. This fills the drain trap pipes to prevent holding tank odors from entering the coach during storage.

### Dump and Clean Holding Tanks

13. Completely drain the sewage and waste water holding tanks at an approved waste disposal site. Drain the sewage tank first so the following waste water can rinse any waste solids from the sewage drain outlet and sewer hose.

14. Flush the sewage tank using the Black Waste Tank Flush Inlet.
15. Close dump valves and refit the dust cap onto the drain outlet.  
This will inhibit rust formation on valve shafts and prevent entry and contamination by airborne debris, insects, and rodents.

***Your drainage and fresh water systems are now winterized.***

***See instructions for removal from storage in Section 11 - Maintenance and Storage.***

---

---

## WINTERIZING OPTIONAL APPLIANCES

### Winterizing Ice Maker (Residential Refrigerator)

1. Shut off water supply to the Ice Maker and/or water dispenser. The water supply valve is located inside a galley cabinet near the filter.
2. Remove Ice Maker Drain Line from exterior Residential Refrigerator service compartment and allow to hang loose on outside of vehicle.



Ice Maker Drain Line  
(Located in exterior Residential  
Refrigerator service compartment)

3. Turn Ice Maker Winterization Drain valve to the OPEN position.



**Ice Maker Winterization Drain Valve**  
(Located in exterior Residential Refrigerator service compartment)

*NOTE: Leave the Ice Maker Winterization Drain valve in the OPEN position throughout storage period.*

4. After the last batch of ice dispenses, raise the wire shut-off arm to the OFF position.
5. Empty ice bin.

**To use Ice Maker again after seasonal storage:**

1. Flush antifreeze from the waterlines (if antifreeze fill winterization procedure was performed).
2. Close all drain valves.
3. Turn Ice Maker Winterization Drain valve to the CLOSED position.
4. Turn the water supply ON.
5. Ensure the ice bin is in place and the wire shut-off arm is lowered to the ON position.
6. Allow the refrigerator to cool down to ice making temperature. Remember, this can take up to 24 hours.

*NOTE: Discard the first two batches of ice cubes. It will take approximately three cycles for the Ice Maker to produce fully formed, clean ice cubes.*

**Further Information**

Refer to the refrigerator manufacturer's user guide provided in your InfoCase for complete winterizing information.

**Winterizing Washer/Dryer  
(Stackable)**

**–If Equipped**

**Method 1 – Drain Water**

If you have decided to completely drain the coach waterlines, follow these steps to winterize your Washer/Dryer:

1. With the Washer/Dryer power OFF, pour 1/2 quart of RV-type antifreeze into the Washer drum.
2. Close door. Advance Cycle Selector to “B”.
3. Press ON/OFF button, then press START. Let the Washer/Dryer run for 1 to 2 minutes.
4. Press ON/OFF button to turn power OFF.
5. Unplug Washer/Dryer from electrical outlet (or disconnect power).
6. Turn Water Supply Faucets OFF. Disconnect inlet hoses from faucets.
7. Drain remaining water from hoses. Finished.

**To use Washer/Dryer again after seasonal storage:**

1. Reconnect water inlet hoses to corresponding HOT/COLD faucets. Turn faucets ON.

*NOTE: Check water inlet hoses and pump periodically (see manufacturer's user guide for further information).*

2. Plug Washer/Dryer into electrical outlet (or reconnect power).
3. With Washer/Dryer power OFF, pour 1/2 TBSP. of powder detergent (or liquid equivalent) into “Compartment 2” inside Dispenser Drawer.
4. Advance Cycle Selector to “Position 4”.
5. Press ON/OFF button, then press START.
6. Allow machine to run through the complete cycle to clean out any remaining antifreeze. Finished.

**Method 2 – Fill with RV Antifreeze**

If you have decided to fill the coach waterlines with RV antifreeze, follow these steps to winterize your Washer/Dryer:

1. With machine power OFF, advance Cycle Selector to “Position 3”.

## SECTION 7 – PLUMBING

---

2. Press ON/OFF button, set water temperature to WARM, then press START. Let machine fill until the drum turns (this could take up to 1 to 2 minutes).
3. Press ON/OFF button to turn power OFF.
4. Advance Cycle Selector to “B”.
5. Press ON/OFF button, then press START.
6. After letting antifreeze drain completely from drum, press the ON/OFF button to turn power OFF. Finished.

### **To use Washer/Dryer again after seasonal storage:**

1. Reconnect water inlet hoses to corresponding HOT/COLD faucets. Turn faucets ON.

*NOTE: Check water inlet hoses and pump periodically (see manufacturer’s user guide for further information).*

2. Plug Washer/Dryer into electrical outlet (or reconnect power).
3. With Washer/Dryer power OFF, pour 1/2 TBSP. of powder detergent (or liquid equivalent) into “Compartment 2” inside Dispenser Drawer.
4. Advance Cycle Selector to “Position 4”.
5. Press ON/OFF button, then press START.
6. Allow machine to run through the complete cycle to clean out any remaining antifreeze. Finished.

### **Winterizing Dishwasher –If Equipped**

Follow manufacturer’s instructions provided in your InfoCase for operating and for interrupting cycles.

1. Empty all dishes from the Dishwasher.
2. Follow coach winterization instructions for using the winterization valve to draw RV water system antifreeze into the water system so antifreeze can enter the Dishwasher.
3. Set the Dishwasher controls to the start of the Rinse cycle and run briefly until antifreeze can be seen inside the dishwasher.

4. Set the controls to the end of the Rinse cycle to pump the liquid out of the Dishwasher to make sure the lines and pump contain antifreeze.
5. Turn Dishwasher controls to OFF.
6. Pour approximately one quart of RV water system antifreeze directly into the Dishwasher to ensure protection of pump and drain lines.
7. Dishwasher is now winterized.

### **To use Dishwasher again after seasonal storage:**

1. Flush antifreeze from the waterlines (if antifreeze fill winterization procedure was performed).
2. Set the Dishwasher controls to the start of the Rinse cycle and run briefly until antifreeze can be seen inside the dishwasher.
3. Set the controls to the end of the Rinse cycle and allow the machine to run through the complete cycle to clean out any remaining antifreeze.

<b>WATER SYSTEM DRAIN VALVE LOCATIONS</b>	
<b>SYSTEM</b>	<b>DRAIN VALVE LOCATION</b>
<b>Waterlines</b>	<ul style="list-style-type: none"> <li>• Two (2) waterline drain valves located in the third compartment on passenger side.</li> <li>• Open exterior shower faucet and lay shower head on ground. <i>Also, to drain any water left in the city waterline, place the tip of your finger inside the city water connection and gently press the backflow valve (small “button” in center of connector).</i></li> </ul>
<b>Water Tank</b>	<ul style="list-style-type: none"> <li>• One (1) valve located in the third compartment door on passenger side. Turn to drain.</li> </ul>
<b>Winterization Valve 2 (Antifreeze)</b>	<ul style="list-style-type: none"> <li>• Valve with clear vinyl siphon tube is located in the third compartment on passenger side.</li> </ul>





# SECTION 8 – ENTERTAINMENT

## HDMI VIDEO SELECTION SYSTEM

The HDMI Video Selection System allows you to watch high definition video from multiple sources on multiple TV's at the same time. You can select either *Blu-ray*, *Satellite Receiver 1*, *Satellite Receiver 2*, or *Auxiliary (Dash Radio House Mode)*.

TVs connected to this system are the Lounge TV, 2nd Lounge TV (if equipped), Bedroom TV, and Exterior Entertainment Center TV.

All TV's and A/V sources operate from 120-volt AC household current only, so you must have either the shoreline connected, the generator running, or the inverter turned on (if equipped).

*NOTE: Red lights that are illuminated on the HDMI Video Selection System and the Secondary Source Selector indicate that video sources are active. Blue lights that are illuminated indicate the selected video source.*



HDMI Video Selection System  
(Located in front passenger overhead cabinet)

*NOTE: There will be a slight delay when changing sources. Winnebago Industries® recommends setting each component to a maximum video output resolution of 1080i for proper operation.*



HDMI Video Selector Control  
(Located in your InfoCase Box)

- Used to control main HDMI Video Selection System only.

## Select Video Source and TV



HDMI Video Selection System

- Power "ON" TV, HDMI Video Selection System, TV, Sound Bar (if desired), and Video source (DVD player, Satellite receiver(s), or Dash radio).
- Press and release button for desired TV viewing (e.g. BEDROOM for bedroom TV) until the number is lit for the desired source (e.g. Blu-Ray).
- At the TV, ensure the source (or input) is set to HDMI.

## Secondary Source Selector

A Secondary Source Selector is provided at each TV for your convenience. Press the Select button to toggle to preferred source.



Secondary Source Selector  
(Located near each TV)



Secondary Source Selector Control  
(Located in your InfoCase Box)

## Infrared Emitters

The HDMI Video Selection System in your coach is also featured with Infrared Emitters (connected to both Accessory Connection Cables), which are used to extend the remote control from all TV's in the coach to either Satellite 1 or Satellite 2. Install Infrared Emitter by removing the protective cover from adhesive and place directly in front of the I.E. Receiver on the component.

## SECTION 8 – ENTERTAINMENT



• Infrared Emitter

### Connecting Satellite Dish Receiver

- Connect Satellite Receiver to the Accessory Connection Cable (Satellite Receiver 1 or 2.) These cables are located in a front overhead cabinet.



**Accessory Connection Cables**

\* Satellite Receiver 1 and Satellite Receiver 2

### To Watch a Blu-ray

1. Insert Blu-ray into the player. Blu-ray will begin to load automatically.
2. The Blu-ray may load directly to the main title/menu screen or it may begin to play previews. You may be able to skip previews if desired by pressing the chapter “skip” button on the Blu-ray player remote until you see the main menu screen.
3. When the main menu screen appears, use the arrow buttons on the Blu-ray player remote to select the desired entry or press the “Enter” button on the Blu-ray player remote to begin playing the feature.



### Further Information

Refer to the manufacturer’s user guide provided in your InfoCase for complete operating instructions.

---

## HDMI VIDEO SELECTION SYSTEM

The HDMI Video Selection System allows you to watch high definition video from multiple sources on multiple TV’s at the same time.

TVs connected to this system are:

- *Output A - Lounge TV*
- *Output B - Bedroom TV*

- *Output C - Exterior Entertainment Center TV*
- *Output D - 2nd Lounge TV/Bathroom (if equipped)*

You can select either:

- *1 = Blu-ray*
- *2 = Satellite Receiver 1*
- *3 = Satellite Receiver 2*
- *4 = Auxiliary (Dash Radio House Mode).*

All TV’s and A/V sources operate from 120-volt AC household current only, so you must have either the shoreline connected, the generator running, or the inverter turned on (if equipped).

*NOTE: Green lights that are illuminated on the HDMI Video Selection System indicate that video sources are active.*



HDMI Video Selection System  
(Located in front passenger overhead cabinet)

*NOTE: There will be a slight delay when changing sources. Winnebago Industries® recommends setting each component to a maximum video output resolution of 1080i for proper operation.*



HDMI Video Selector Control  
(Located in your InfoCase Box)

- Used to control main HDMI Video Selection System only.

### Select Video Source and TV



HDMI Video Selection System

- Power “ON” TV, HDMI Video Selection System, TV, Sound Bar (if desired), and Video source (DVD player, Satellite receiver(s), or Dash radio).

- Press and release button for desired TV viewing (e.g. “Output B” for bedroom TV) until the number is lit for the desired source (e.g. Blu-Ray).
- At the TV, ensure the source (or input) is set to HDMI.

### **Infrared Emitters**

The HDMI Video Selection System in your coach is also featured with Infrared Emitters (connected to both Accessory Connection Cables), which are used to extend the remote control from all TV’s in the coach to either Satellite 1 or Satellite 2. Install Infrared Emitter by removing the protective cover from adhesive and place directly in front of the I.E. Receiver on the component.



• Infrared Emitter

### **Connecting Satellite Dish Receiver**

- Connect Satellite Receiver to the Accessory Connection Cable (Satellite Receiver 1 or 2.) These cables are located in a front overhead cabinet.



**Accessory Connection Cables**

\* Satellite Receiver 1 and Satellite Receiver 2

### **To Watch a Blu-ray**

1. Insert Blu-ray into the player. Blu-ray will begin to load automatically.
2. The Blu-ray may load directly to the main title/menu screen or it may  begin to play previews. You may be able to skip previews if desired by pressing the chapter “skip” button on the Blu-ray player remote until you see the main menu screen.

3. When the main menu screen appears, use the arrow buttons on the Blu-ray player remote to select the desired entry or press the “Enter” button on the Blu-ray player remote to begin playing the feature.

### **Further Information**

Refer to the manufacturer’s user guide provided in your InfoCase for complete operating instructions.

---

---

### **FRONT TV IGNITION SWITCH INTERLOCK**

#### **–If Equipped**

If your coach is equipped with a front overhead TV, it is plugged into a special electrical outlet with a built-in ignition switch interlock. The device allows the front overhead TV to operate only when the ignition key is in the Off or Accessory positions.

---

---

### **AUDIO/VIDEO SYSTEM BASIC OPERATION**

*NOTE: For your convenience, we have also included a handy, tear-out version of this “A/V System Basic Operation” guide in Section 8 of your Operator’s Manual Supplement.*

*See your InfoCase for specific operating guides for audio and video components.*

---

---

### **SOUND BAR SYSTEM**

#### **–If Equipped**

The Sound Bar System operates from 120-volt AC household current only, so you must have either the shoreline connected, the generator running, or the inverter turned on (if equipped). The TV is connected to the Sound Bar.

#### **TV Sound through the Sound Bar**

When watching TV programs (broadcast, cable, or satellite), the TV normally plays sound through its own built-in stereo speakers. To connect TV sound output to the Sound Bar for a richer sound quality, follow these steps:

## SECTION 8 – ENTERTAINMENT

---

- Turn “ON” the TV and Sound Bar.
- Select the TV channel you wish to watch.
- Press the “Source” button on the Sound Bar remote until the display reads “D.IN”.
- Turn Sound Bar volume up or down.

### Listen to Music stored on a Bluetooth device

- Press the “Source” button on the top panel of the Sound Bar or on the Sound Bar remote until display reads “BT”.
- On your Bluetooth device, perform the pairing operation. A list of devices found will appear on your device. Select the Sound Bar.
- Enter the PIN code 0000 (if required).
- When the devices are paired, the Sound Bar will display the device name.
- Turn the Sound Bar volume up or down.

### Lounge TV with Sound Bar System

- Turn on TV and ensure TV source is set to HDMI by pressing the source or input button on the TV remote.
- Turn on the sound bar and set the input to optical.
- Volume is controlled by the sound bar remote.

*NOTE: TV will operate without using the sound bar if desired.*

### Bedroom TV with Sound Bar System

- Turn on TV and ensure TV source is set to HDMI by pressing the source or input button on the TV remote.
- Turn on the sound bar and set the input to optical.
- Volume is controlled by the sound bar remote.

*NOTE: TV will operate without using the sound bar if desired.*

### Exterior TV with Sound Bar System

- Turn on TV and ensure TV source is set to HDMI by pressing the source or input button on the TV remote.
- Turn on the sound bar and set the input to optical.
- Volume is controlled by the sound bar remote.

*NOTE: TV will operate without using the sound bar if desired.*

### Turning TV Speakers On/Off

TV speakers can be turned off to prevent an echo effect when using an external speaker (sound bar). Every TV is slightly different, refer to the TV manufacturer’s user guide provided in your InfoCase for detailed instructions on turning TV speakers off.

### Further Information

See the manufacturer’s user guide provided in your InfoCase for complete feature descriptions and operating instructions.

---

---

## BOSE® SOUND BAR SYSTEM

### –If Equipped

The Sound Bar System operates from 120-volt AC household current only, so you must have either the shoreline connected, the generator running, or the inverter turned on (if equipped). The TV is connected to the Sound Bar.

### Lounge TV with Sound Bar System To calibrate Sound Bar (if not previously calibrated)

*NOTE: You will only need to calibrate your system one time.*

1. Turn “ON” the TV and Sound Bar.
2. Place the ADAPTiQ headset on your head making sure the left and right sensors rest above your ears.
3. Connect the ADAPTiQ headset into the port located on the back of the sound bar.
4. Press the sound touch button on the remote control. Then press and hold “8” on the remote control until the TV indicator and bluetooth indicator illuminate green.
5. Follow the on-screen instructions given to you by the system.
6. When calibration is complete, remove the ADAPTiQ headset.

### **Video Source from HDMI Matrix**

The audio and video signal from the HDMI matrix is received by the sound bar and then sent to the TV. Power on the sound bar and TV in order to enjoy the desired video source from the HDMI matrix.

- Press HDMI 1 button on the sound bar remote.
- Verify TV source is set to HDMI by pressing source or input button on the TV remote.
- Volume is controlled by the sound bar remote.

### **Video Source from TV (broadcast or cable)**

- Press source or input button on TV remote and select “Air” or “Cable”.
- Press “TV Input” button on sound bar remote. 
- Volume is controlled by the sound bar remote.

### **Listen to Music stored on a Bluetooth device**

- Press the Bluetooth button on the sound bar remote. 
- On your Bluetooth device, perform the pairing operation. A list of devices found will appear on your device. Select the Sound Bar.
- Enter the PIN code 0000 (if required).
- When the devices are paired, the Sound Bar will display the device name.
- Turn the Sound Bar volume up or down.

### **Bedroom TV with Sound Bar System**

- Turn on TV and ensure TV source is set to HDMI by pressing the source or input button on the TV remote.
- Turn on the sound bar and set the input to optical.
- Volume is controlled by the sound bar remote.

*NOTE: TV will operate without using the sound bar if desired.*

### **Exterior TV with Sound Bar System**

- Turn on TV and ensure TV source is set to HDMI by pressing the source or input button on the TV remote.
- Turn on the sound bar and set the input to optical.
- Volume is controlled by the sound bar remote.

*NOTE: TV will operate without using the sound bar if desired.*

### **Turning TV Speakers On/Off**

TV speakers can be turned off to prevent an echo effect when using an external speaker (sound bar). Every TV is slightly different, refer to the TV manufacturer’s user guide provided in your InfoCase for detailed instructions on turning TV speakers off.

### **Further Information**

See the manufacturer’s user guide provided in your InfoCase for complete feature descriptions and operating instructions.

---

---

## **YAMAHA® SOUND BAR SYSTEM**

### **–If Equipped**

The Sound Bar System operates from 120-volt AC household current only, so you must have either the shoreline connected, the generator running, or the inverter turned on (if equipped). The TV is connected to the Sound Bar.

### **Lounge TV with Yamaha® Sound Bar System**

#### **To calibrate Yamaha Sound Bar (if not previously calibrated)**

*NOTE: You will only need to calibrate your system one time.*

- Turn “ON” the TV and Sound Bar.
- Place the IntelliBeam microphone at the same height as your ears would be when you are seated.
- Connect the IntelliBeam microphone to the INTELLIBEAM MIC jack at the front of the unit. 
- The calibration system will start automatically. Follow the on-screen instructions given to you by the system.
- When calibration is complete, remove the IntelliBeam microphone.

## SECTION 8 – ENTERTAINMENT

---

### Video Source from HDMI Matrix

The audio and video signal from the HDMI matrix is received by the Yamaha sound bar and then sent to the TV. Power on the sound bar and TV in order to enjoy the desired video source from the HDMI matrix.

- Press HDMI 1 button on the sound bar remote.
- Verify TV source is set to HDMI by pressing source or input button on the TV remote.
- Volume is controlled by the sound bar remote.

### Video Source from TV (broadcast or cable)

- Press source or input button on TV remote and select “Air” or “Cable”.
- Press “TV” button on sound bar remote.
- Volume is controlled by the sound bar remote.



### Listen to Music stored on a Bluetooth device

- Press the Bluetooth button on the sound bar remote.
- On your Bluetooth device, perform the pairing operation. A list of devices found will appear on your device. Select the Sound Bar.
- Enter the PIN code 0000 (if required).
- When the devices are paired, the Sound Bar will display the device name.
- Turn the Sound Bar volume up or down.



### Bedroom TV with Yamaha Sound Bar System

- Turn on TV and ensure TV source is set to HDMI by pressing the source or input button on the TV remote.
- Turn on the sound bar and set the input to optical.
- Volume is controlled by the sound bar remote.

*NOTE: TV will operate without using the sound bar if desired.*

### Exterior TV with Sound Bar System

- Turn on TV and ensure TV source is set to HDMI by pressing the source or input button on the TV remote.

- Turn on the sound bar and set the input to optical.
- Volume is controlled by the sound bar remote.

*NOTE: TV will operate without using the sound bar if desired.*

### Turning TV Speakers On/Off

TV speakers can be turned off to prevent an echo effect when using an external speaker (sound bar). Every TV is slightly different, refer to the TV manufacturer’s user guide provided in your InfoCase for detailed instructions on turning TV speakers off.

### Further Information

See the manufacturer’s user guide provided in your InfoCase for complete feature descriptions and operating instructions.

---

## INFOTAINMENT CENTER (HOUSE MODE)

### –If Equipped

The Infotainment Center in your coach allows you to view, listen, and control various modes such as SiriusXM® satellite radio or Navigation from the dash radio to all TV’s in your coach while parked.

### Basic Operating Instructions

- Engage the parking brake.
- On the Infotainment System, go to Main Menu and select House Mode. This disables the cab speakers and sends video and audio source from the radio to AUX input (4) on the HDMI matrix.
- Use the dash radio remote control to operate the dash radio from all the TV’s in your coach.

### Further Information

See the manufacturer’s user guide provided in your InfoCase for complete operating instructions.

**TV (DINING BUFFET) – POWER LIFT**

**-If Equipped**

Your coach may be equipped with a TV power lift/lower mechanism which allows you to raise and lower the TV with a touch of a switch.

The control switch is located near the sofa or on the touch tablet (if equipped).



Buffet TV Power Lift/Lower Control Switch  
(Located near sofa)  
-Typical View

- Tap the UP or DOWN arrow to raise or lower TV.
- Tap the UP or DOWN arrow anytime to stop.



Touch Tablet Main Menu

- Tap on "Lounge" (selection displays in white).



Buffet TV Power Lift/Lower Control Switch  
(Located on touch tablet "Lounge" screen)

- Tap the UP or DOWN arrow to raise or lower TV.
- Tap the UP or DOWN arrow anytime to stop.

-If Equipped

*NOTE: Road vibration may damage the TV and/ or power lift mechanism in the extended position.*

1. To raise the TV, press the control switch (located near the sofa) UP and the TV will pop up through the access lid.



2. Continue to raise TV to the height that best suits your viewing needs.
3. To lower the TV back into stored position, press the control switch DOWN. The power lift/lower mechanism will stop automatically when the TV is all the way seated into stored position.

## SECTION 8 – ENTERTAINMENT

*NOTE: Be sure that the buffet counter is clear before raising/lowering the TV to protect the TV, lift/lower mechanism, and personal property from possible damage.*

---

---

### TV ANTENNA – DIGITAL (Winegard® Rayzar® Automatic Antenna) –If Equipped

Your coach is featured with a digital antenna, which provides crystal clear digital HD reception of over-the-air channels in addition to superior broad reception range.

The digital antenna is equipped with a built-in amplifier for maximum VHF and UHF programming.

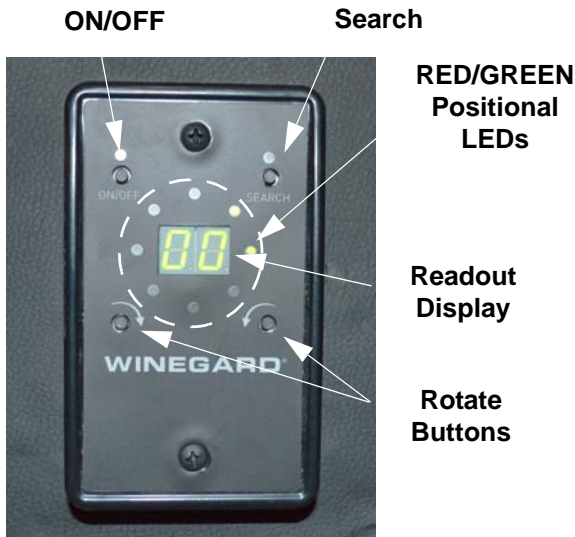
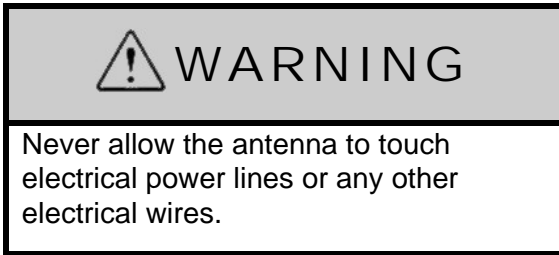

Digital Antenna Power Switch  
(Located inside entrance door  
overhead cabinet)  
-Typical View

- **ON/OFF** - Switch between antenna mode and park cable mode. When in antenna mode, the LEDs will flash and begin to power on. When in cable mode, the LEDs will be turned off.
- **SEARCH** - Press to initiate a new search. The antenna will go through the initialization process and begin searching for TV frequencies. This may take 2-3 minutes. After a search is complete, the antenna will stop at the position with the most watchable TV channels.
- **GREEN POSITIONAL LEDs** - Indicate antenna position.
- **RED POSITIONAL LEDs** - Indicate main antenna pointing location and other unique channels found during the search.
- **ROTATE Buttons** - Fine tune a channel that may be pixelating or weak.
- **READOUT DISPLAY** - Shows the number of TV frequencies found at the current position.

### Operating the Digital Antenna

1. Turn ON the Digital Antenna by pressing the ON/OFF button.
2. Press the Search button to initiate a new search. Within 2-3 minutes, the antenna will be accurately pointed to maximize reception in your location.
3. On your TV Menu, go to Channel Menu and perform a Channel Scan. This will program the stations in your area into the TV. Do this whenever the antenna is re-pointed.

### Further Information

See the antenna manufacturer's user guide provided in your InfoCase for complete operating and maintenance information.



**TV ANTENNA – DIGITAL  
(Jack® Digital HDTV Over-the-Air  
Antenna)**

**–If Equipped**

Your coach is featured with a digital antenna, which provides crystal clear digital HD reception of over-the-air channels in addition to superior broad reception range.

The digital antenna is equipped with a built-in amplifier for maximum VHF and UHF programming.

 <b>WARNING</b>
<p>Never allow the antenna to touch electrical power lines or any other electrical wires.</p>

**Operating the Digital Antenna**

1. Turn the Digital Antenna Power Switch ON.

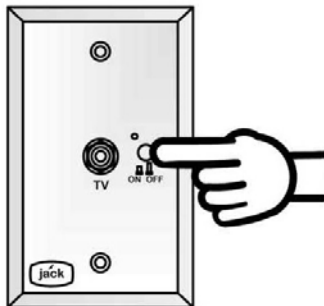

Digital Antenna Power Switch  
(Located in an overhead cabinet or mounted on a wall near the TV)

2. Turn ON the Signal Meter Power switch (located on the side of the Signal Meter).



Digital Antenna Signal Meter  
(Located on ceiling)

3. Rotate the Attenuator Dial fully **CLOCKWISE**.
4. Press Release Button on the Rotational Knob and rotate antenna (until maximum number of LED lights illuminate on the Signal Meter).

*NOTE: LED lights will illuminate from left to right. All LED lights may not illuminate, depending on signal strength.*

5. Rotate Attenuator Dial **COUNTER-CLOCKWISE** until the last illuminated LED light flickers.
6. Rotate antenna to illuminate the last flickering LED light.
7. Repeat Steps 5 and 6 to pinpoint signal reception.

*NOTE: Refer to television manufacturer's instructions to scan for available channels.*

**Further Information**

See the antenna manufacturer's user guide provided in your InfoCase for complete operating and maintenance information.

## SECTION 8 – ENTERTAINMENT

---

---

---

### TV SIGNAL AMPLIFIER

#### –If Equipped

The TV Signal Amplifier is built into the antenna and can be turned on or off with a power switch located on a switchplate in the overhead cabinet above the entrance door.

An indicator light will illuminate when the switch is on and the signal amplifier is active.

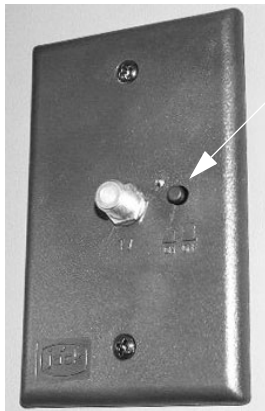

TV Signal Amplifier Power Switch  
(Located in overhead cabinet  
above entrance door)  
-Typical View



Satellite Dish and Cable TV Connections  
(Located in utility compartment, shoreline  
compartment, or water service center,  
depending on model)  
-Typical View

---

---

### TV DIGITAL SATELLITE SYSTEM WIRING

Your coach is pre-wired for installation of a digital satellite TV system. Coaxial cable and high definition component cable connections are available to hook up your satellite receiver and are located in the overhead cabinet above entrance door (remove panel to access).

A second connection may be included inside a cabinet in the bedroom for the rear TV (if equipped).

See your authorized Winnebago Industries® dealer for proper installation and sealing of roof mounted components.

#### To Access Interior Satellite Dish Connections

- Turn each access panel cover latch (located in the overhead compartment above entrance door) “counter-clockwise” completely until you come to a stop.

---

---

### SATELLITE DISH AND CABLE TV CONNECTIONS (INPUT)

#### –If Equipped

The portable satellite dish and cable television input connectors are located in the utility compartment, shoreline compartment, or water service center, depending on model.

To receive a cable signal, turn off the TV Signal Amplifier.



Access Panel Cover Latches  
Turn “counter-clockwise” to remove cover.

- Remove access panel and set aside. You have now accessed the Interior Satellite Dish Connections.



Interior Connections for Satellite Dish  
(Located in the overhead compartment  
above entrance door)

*NOTE: Your coach is pre-wired with two satellite dish coaxial cables from the roof-mounted satellite dish. Both cables are located near the front TV entertainment center cabinet (satellite prep area).  
If you desire a satellite receiver in the bedroom area, a third coaxial cable is provided from the front satellite prep area to the bedroom satellite prep area (a jumper cable is required at the front satellite prep area for operation).*



HDMI Connection Cable  
(Located in cabinet near bedroom TV)

## TV DIGITAL SATELLITE SYSTEM – AUTOMATIC

### –If Equipped

The Automatic Multi-Satellite Television System allows you to receive TV programs directly from satellite to your coach.

We recommend that you read the satellite dish manual thoroughly to understand the system completely before attempting any setups or adjustments.

- The coach must be parked and level before attempting to operate the automatic antenna dish.
- There must be a clear “line of sight” to the satellite. Mountains, buildings, trees, telephone poles and other obstructions can all block the satellite signal from reaching the dish.
- When activated while parked, the dish antenna will seek the selected satellite automatically.



Automatic Multi-Satellite Dish Control  
(Located in overhead cabinet or  
entertainment center cabinet,  
depending on model)  
-Typical View

## SECTION 8 – ENTERTAINMENT

---

### Automatic Operation

1. Press and Hold the Power button for two seconds until the display reads “POWER ON”.
2. The antenna will start the “searching” process first locating the home position. Then it will lock onto three different satellites. The antenna will display an asterisk for each satellite found.
3. To turn off the power after it has locked onto satellites, press the “POWER” and “SELECT” buttons at the same time.

*Note: The Automatic Multi-Satellite antenna is not meant for use while traveling. Do not move the vehicle until the antenna is stowed.*

### Further Information

See the Automatic Multi-Satellite System owner’s manual in your InfoCase for a complete description of features and instructions.

---

---

## EXTERIOR ENTERTAINMENT CENTER (ADJUSTABLE)

### –If Equipped

Your coach may be equipped with an Exterior Entertainment Center, which contains an HDTV with Sound Bar and Subwoofer for your outdoor listening or viewing pleasure. The Exterior TV and Soundbar is mounted on an adjustable bracket which allows you to angle the TV to best suit your viewing needs. The subwoofer is located inside the right front compartment.

*NOTE: Refer to “HDMI Video Selection System” elsewhere in this section for exterior FM stereo and home theater capability.*

These electronic devices and speakers are not designed to be waterproof. Please take measures to prevent rain or other precipitation from entering the entertainment center by closing the compartment door or ensuring that an awning will prevent entrance of precipitation.

### To Swivel TV

1. Pull the black strap (located below the TV) straight out to release the TV from the mounting bracket.



2. Pull the TV out and pivot to desired position.
3. Rotate TV back to center position and press straight back. You will hear a “click” when the TV is secured into locked position.

### TV Sound through the Sound Bar (Exterior TV Only)

#### –If Equipped

When watching TV programs (broadcast, cable, or satellite), the TV normally plays sound through its own built-in stereo speakers. To connect TV sound output to the Sound Bar for a richer sound quality, follow these steps:

- Turn “ON” the TV and Sound Bar.
- Select the TV channel you wish to watch.
- Press the “Source” button on the Sound Bar remote until the display reads “D.IN”.
- Turn TV and/or Sound Bar volume up or down.

### Turning TV Speakers On/Off

TV speakers can be turned off to prevent an echo effect when using an external speaker (sound bar). Every TV is slightly different, refer to the TV manufacturer’s user guide provided in your InfoCase for detailed instructions on turning TV speakers off.

## **TV Sound through Subwoofer (Exterior TV Only)**

### **–If Equipped**

- Remove subwoofer from inside the right front compartment.
- Plug the subwoofer into the outlet (located above the Central Vacuum Cleaner) inside the right front compartment.
- Turn on the subwoofer.

## **Listen to Music stored on a Bluetooth device**

### **–If Equipped with Sound Bar**

- Press the “Source” button on the top panel of the Sound Bar or on the Sound Bar remote until display reads “BT”.
- On your Bluetooth device, perform the pairing operation. A list of devices found will appear on your device. Select the Sound Bar.
- Enter the PIN code 0000 (if required).
- When the devices are paired, the Sound Bar will display the device name.
- Turn the Sound Bar volume up or down.

## **Further Information**

Please read the manufacturer’s user guide in your InfoCase for complete operating instructions.



## SECTION 9 – FURNITURE AND SOFTGOODS

---

### LOUNGE CHAIR – SWIVEL

**–If Equipped  
(Typical View – Your coach may differ in appearance)**

This chair is not equipped with a seat belt and is not intended for seating while the vehicle is in motion.

When the vehicle is in motion, the base of the Lounge Chair must be fastened to the floor using the provided base clamp, as shown.



 <b>WARNING</b>
The chair must be clamped back into place before driving the coach.



Lounge Chair Base Clamp  
(Travel position shown)  
-Typical View

When the vehicle is parked, you may unscrew the knob and remove the base clamp to position the chair away from the wall.

### SLIDING BUFFET TABLE AND CHAIRS

**–If Equipped  
(Typical View – Your coach may differ in appearance)**

#### Buffet Chairs

The Buffet Chairs are free-standing to allow greater freedom of movement. Before driving, always return Buffet Chairs to their storage location.

 <b>WARNING</b>
This chair not intended for occupancy when vehicle is in motion and must be returned to the stowed position.

Folding chairs are also provided for additional seating when needed. The folding chairs are typically stored in an exterior compartment, under the bed, inside cabinet near the table, or inside the wardrobe, depending on model.

**Free-standing chairs are not intended for occupancy while the vehicle is in motion and must be stored before driving.**

## SECTION 9 – FURNITURE AND SOFTGOODS



### WARNING

Properly secure all free-standing chairs, furniture, and loose items prior to driving. Moving items can cause driver distraction, possibly resulting in an accident that can result in death or serious injury.

### Storing Buffet Chairs

*NOTE: Table Extension Leaf must be removed before storing dinette table and chairs.*

1. Pull release lever and slide the table to the center position until it locks into place.



2. Push chairs against opposite sides of the buffet table (*as shown in Step 4*).
3. Bind chairs together with the provided strap, ensuring the strap goes through the ring located on the bottom side of the buffet table.



4. Latch strap and tighten as necessary for security.



### Buffet Table Extension

1. Grasp the edge of the buffet table and pull all the way out.
2. Remove table leaf extension from storage location.

*NOTE: The table extension leaf is stored in the rear wardrobe, in a cabinet near the dinette, or beneath the bed.*



3. Insert table extension leaf onto table frame and align the table extension pegs. Push together table and leaf.

*NOTE: Your coach may have one or two table leaves, depending on model.*





4. Push edge of buffet table in until it locks into place.



- Reverse steps to store table extension leaf.

### **Sliding Table**

1. Pull release lever.



2. Slide the table to the desired location.

## **SLEEPING FACILITIES**

### **! WARNING**

Sleeping facilities are not intended for use while vehicle is in motion. For safety, passengers must use safety belted seating positions while vehicle is in motion.

## **SOFA/DINETTE (SUPER LOUNGE)**

**–If Equipped  
(Typical View – Your coach may differ in appearance)**

### **Dining Table Extension**

1. Grasp the edge of the dining table and pull all the way out.
2. Remove table leaf extension from storage location.

*NOTE: The table extension leaf is stored in the rear wardrobe.*



3. Insert table extension leaf onto table frame and align the table extension pegs. Push together table and leaf.

## SECTION 9 – FURNITURE AND SOFTGOODS



4. Push edge of dining table in until it locks into place.



*NOTE: The folding table chairs are stored in a cabinet near the dining table.*

**Free-standing chairs are not intended for occupancy while the vehicle is in motion and must be stored before driving.**



### WARNING

Properly secure all free-standing chairs, furniture, and loose items prior to driving. Moving items can cause driver distraction, possibly resulting in an accident that can result in death or serious injury.

- Reverse steps to store table extension leaf and folding chairs.

## Recliner/Headrest Operation

Power Switches for the Recliner and Headrest are located on the adjustable armrest for the rear sofa seat and front armrest on the front sofa seat.

### Recline Switch

- Push switch UP to Recline the sofa seat back.
- Push switch DOWN to return sofa seat back to the upright position.



### Headrest Switch

- Push switch to raise or lower the headrest.

## Sofa/Sleeper Conversion

### NOTICE

Stow furniture extension before retracting slide rooms.

1. Remove sofa seat cushions and set aside.

2. Using the grab handle, pull the sofa/sleeper out and extend all the way down to the floor.



3. Unfold the bottom section of the sofa/sleeper and extend all the way down to the floor.



## **Storing Sofa/Sleeper**

1. Lift up the bottom section of the sofa/sleeper and bring all the way up and fold over.



2. Using the grab handle, lift and push sofa/sleeper into stored position.



3. Replace the sofa seat cushions.

---

---

## **SOFA/SLEEPER**

**–If Equipped  
(Typical View – Your coach may differ in appearance)**



## SECTION 9 – FURNITURE AND SOFTGOODS

### NOTICE

Stow furniture extension before retracting slide rooms.

### Sofa/Sleeper Conversion

1. Remove sofa seat cushions and set aside.
2. Using the grab handle, pull the sofa/sleeper out and extend all the way down to the floor.



3. Unfold the bottom section of the sofa/sleeper and extend all the way down to the floor.



### Storing Sofa/Sleeper

1. Lift up the bottom section of the sofa/sleeper and bring all the way up and fold over.



2. Using the grab handle, lift and push sofa/sleeper into stored position.



3. Replace the sofa seat cushions.

**EXTENDABLE SECTIONAL  
SOFA/SLEEPER**

**–If Equipped  
(Typical View – Your coach may differ in  
appearance)**



**NOTICE**

Stow furniture extension before retracting  
slide rooms.

**Sectional Extension**

- Engage and Hold the black lever (located on the inboard sectional sofa arm) and fully extend sectional extension.



- Remove seat cushion from sectional extension by using the provided pull strap.



- Turn seat cushion over and reinstall onto sectional frame. Ensure the four engagement brackets are firmly seated onto the frame.



## SECTION 9 – FURNITURE AND SOFTGOODS

- Install sectional seat back cushion.



- Reverse steps to store sectional extension.

### Sofa/Sleeper Conversion

1. Remove sofa seat cushions and set aside.
2. Using the grab handle, pull the sofa/sleeper out and extend all the way down to the floor.



3. Unfold the bottom section of the sofa/sleeper and extend all the way down to the floor.



### Storing Sofa/Sleeper

1. Lift up the bottom section of the sofa/sleeper and bring all the way up and fold over.



2. Using the grab handle, lift and push sofa/sleeper into stored position.



3. Replace the sofa seat cushions.

## DIGITAL SLEEP AIR BED

by Innomax®

### –If Equipped

The air bed operates on 120-volt AC household current only, so you must have the shoreline plugged in, the generator running, or inverter power (if equipped) to adjust the air pressure settings in this bed.

If loss of power occurs, the memory setting will default to the pre-set threshold and re-programming the memory setting will be necessary.

*NOTE: If your bed is equipped with the power lift feature, it is recommended to deflate the air mattress to 25 or below when elevating the bed into the fully upright position. This will help prolong the life of your air mattress.*



Air Bed Remote Control  
–Typical View

### Basic Operation

1. Push “Bed Fill” once to fill air chamber.
2. Push “Soft” for comfort level.
3. When comfortable, push “Memory” button and hold until desired set point preference appears. Memory is now set.
4. When awake push “Bed Fill” once for Bed Ready.

5. When in sleep system push “Memory” twice for desired sleep mode.

### Further Information

For complete operating instructions and cautions, see the Innomax air bed user guide included in your InfoCase.

## BED – POWER LIFT

### –If Equipped

**(Typical View – Your coach may differ in appearance)**

Your coach may be equipped with a power lift/lower mechanism that raises and lowers the head of your bed with a touch of a switch to best suit your comfort needs.

The Power Lift/Lower Control switch is located on overhead cabinet above bed.



Power Lift/Lower Control Switch  
(Located on overhead cabinet above bed)  
–Typical View

*The switch will illuminate blue when the switch is on. White illumination indicates the switch is off.*

- Press the control switch UP to raise the head of the bed.
- Press the control switch DOWN to lower the head of the bed.

## SECTION 9 – FURNITURE AND SOFTGOODS



### WARNING

Keep people away from operating mechanism and pinch hazard areas during use. Failure to do so could cause injury.

*NOTE: The power lift/lower mechanism is equipped with an interlock feature, which will not allow you to retract the bedroom slideout unless the bed is in the fully upright position. The bed will also not recline unless the slideout is fully extended.*

### NOTICE

Bed must be in the fully upright (vertical) position to fully retract slideroom.

## POWER SHADES – NIGHT (12-VOLT)

Your coach may feature 12V Night Shades that provides light-blocking capabilities. The 12V Night Shades are located in the front cab, lounge and bedroom areas of your coach.

The Chassis Battery Disconnect switch must be ON to supply power to the solar/night shade.

*NOTE: If power is gradually drained and falls below the lower limit of 11-volts, the motors may lose their electronic set limits and will require reprogramming once normal power has been restored. Refer to the Solar/Night Shade manufacturer's information provided in your InfoCase.*

## Power Shade Switches

The power switches for the 12V Night Shades are conveniently located throughout your coach. Press the switch up or down to adjust the shade to the setting that best suits your needs.



12-Volt Night Shade Switches - Lounge  
\*Switch located by sofa shown  
-Typical View

- D/S SHADES - opens or closes the driver side night shades.
- P/S SHADES - opens or closes the passenger side night shades.
- ALL FRT SHADES - opens or closes the driver side and passenger side shades along with the windshield shade.

*The switch will illuminate blue when the switch is on. White illumination indicates the switch is off.*



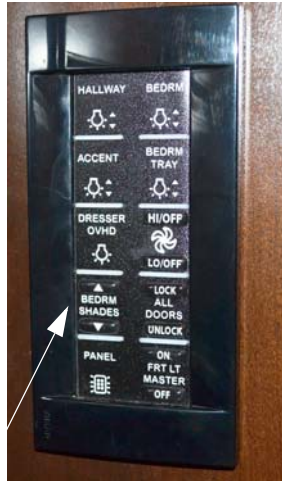

**12-Volt Night Shade Switches - Bedroom**  
 \*Switch located by wardrobe shown. A second switch is located above the bed for your convenience.  
 -Typical View

*The switch will illuminate blue when the switch is on. White illumination indicates the switch is off.*

**Touch Tablet Switches (if equipped)**

Your coach may also feature a touch tablet that controls all shades from one convenient location. You can control each shade individually or area of coach (zone) by using the Master Shade switch.



**Touch Tablet Main Menu**

- Tap on “Lounge” or “Bedroom” (selection displays in white).

**Master Shade Switch**



**12-Volt Night Shade Switches (Located on touch tablet)**

\*Lounge shown

1. Tap on Shades.
  - White text indicates ON
  - Black text indicates OFF
2. Tap arrow to activate designated shade.
3. Tap again to stop shade before it reaches the end of cycle.

-If Equipped

**Further Information**

Refer to the manufacturer’s user guide provided in your InfoCase for complete operating instructions, troubleshooting tips, and maintenance care.

**ROLLER SHADES (MANUAL) – SOLAR/BLACKOUT**

**–If Equipped**

Your coach may feature two-stage day/night roller shades that provide both solar heat protection and light-blocking capabilities.

The shade can easily be lowered by hand to any position, then retracted with a slight downward pull movement. When raising the shade, there is no need to hold onto the bottom of the shade - just simply let it go and it will rise at a slow, controlled rate.

## SECTION 9 – FURNITURE AND SOFTGOODS

---

You can pre-set the auto-stop positioning of your shade, which allows your shade to retract to a cushioned stop, at the positioning of your choice.



-Typical View

### Further Information

For further operating information and care instructions, see the manufacturer's user guide provided in your InfoCase.

---

---

## WOOD FURNITURE AND CABINETRY

### -If Equipped

People are drawn to the natural beauty of wood. At Winnebago Industries®, our craftsmen work with the art found in each piece of wood to create cabinets of superior quality, backed by the Winnebago Industries warranty.

- Oak is a strong, open-grained hardwood that ranges in color from white to pink and reddish tones. Streaks of green, yellow, and even black may appear due to mineral deposits. Oak may also contain wormholes and wild, varying grain patterns. This distinct graining is considered a desirable quality and has made oak one of the most popular woods used for cabinetry.
- Maple is a close-grained hardwood that is predominately white to creamy-white in color, with occasional reddish-brown tones. While maple typically features uniform graining as compared to other wood species, characteristic markings may include fine

brown lines, wavy or curly graining, bird's eye dots and mineral streaks. These traits are natural and serve to enhance maple's natural beauty.

- Cherry is characterized by its red undertones, but may vary in color from white to a deep, rich brown. Cherry is a close-grained wood with fairly uniform texture, revealing pin knots and curly graining. All wood will age with time and the finish will darken. This is especially true for cherry. This is a sought-after quality in cherry cabinetry, and those who select it expect this evolution.

No matter which species you chose for your new Winnebago Industries motorhome cabinetry, please keep in mind that no two pieces of wood are exactly the same.

Stains are likely to exaggerate the difference between open and closed grains and other markings in wood. Grain variation and color change should be expected. As hardwood ages, it will darken when exposed to different types of light. Color differences or changes in wood can also be caused by exposure to harsh chemicals, extreme heat, or other contributing external conditions.

Any color change that occurs in both the finish and the wood is considered part of the natural aging process and is not to be considered defect or damage.

Additionally, wood species exhibit other defining characteristics, such as mineral deposits/streaks, knots, sap runs, pin holes, and wormholes. These markings make the wood unique and contribute to its enduring beauty.

Therefore, since wood is a product of nature and will have certain natural characteristics and variances, they are not covered under the warranty.

# SECTION 10 – SLIDEOUT ROOMS AND LEVELING

## SLIDEOUT ROOM LOCK SYSTEM

The ignition key must be placed in the on or run position to operate the slideout room(s). The park brake must be applied for the room(s) to run. Winnebago recommends running the engine whenever you run the slideout rooms in or out, the engine alternator should insure the rooms have adequate 12-volt DC power to operate correctly.

## SLIDEOUT ROOM TRAVEL LOCKS – ELECTRIC

### -If Equipped

Some models are equipped with electric Slideout Room Travel Locks on slideout rooms to restrict movement of the slideout room while the vehicle is in motion. The slideout room will not extend until the lock is fully released.

Slideout Room Travel Lock switches are located inside the overhead cabinet above the main entrance door or on the touch tablet (if equipped).

Your coach is equipped with one of the slideout room travel locks shown below.



Slideout Room Travel Lock  
(Your model may be equipped with one or more types)  
-Typical View



Touch Tablet Main Menu

- Tap on “Exterior” (selection displays in white).



Slideout Room Travel Lock  
(Located on touch tablet “Exterior” screen)

- Push and Hold to Lock or Unlock slideout rooms.  
-If Equipped

## SECTION 10 – SLIDEOUT ROOMS AND LEVELING

---

### NOTICE

Release Slideout Lock before attempting to extend slideout room. The room will not extend until the lock is fully released. Fasten Slideout Lock before driving vehicle. See following instructions.

**NOTE:** *Be sure locks are fully released before attempting to extend or retract room. If the latch mechanisms are protruding more than 1/4", the room will not extend or retract.*

### To Release

- Press and hold the UNLOCK side of the Slideout Room Travel Lock switch for approximately 7 seconds. (You may be able to hear the lock motor sound stop).

### To Lock

- Press and hold the LOCK side of the Slideout Travel Lock switch for approximately 7 seconds. (You may be able to hear the lock motor sound stop).

### Slideout Lock Drain Line

If your coach is equipped with electric Slideout Room Travel Locks, it is recommended to periodically inspect the slideout lock drain line (located near the top of the exterior slideout room).

**NOTE:** *Depending on the length of your slideout room, there may be two Slideout Room Travel Locks. Therefore, two drain lines will need to be inspected (typically one located on each end of the slideout room).*

It is possible for dirt and debris to collect inside the drain line and cause obstruction, not allowing water to drain properly. If the drain line is plugged, use a small tool (i.e. pipe cleaner) to dislodge any debris. Failure to comply may result in water backing up inside the drain line, resulting in water leaks and/or property damage.

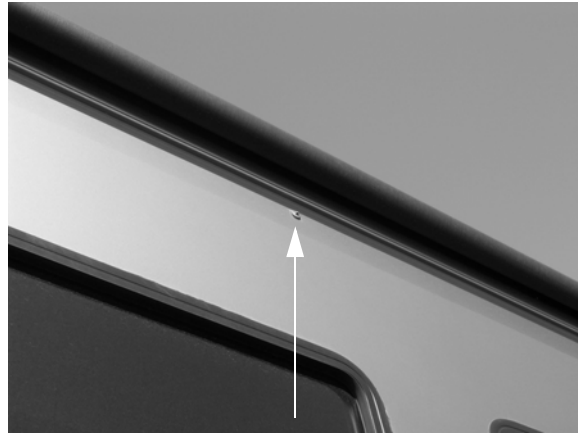

Slideout Lock Drain Line  
(Located near the top of the exterior slideout room)

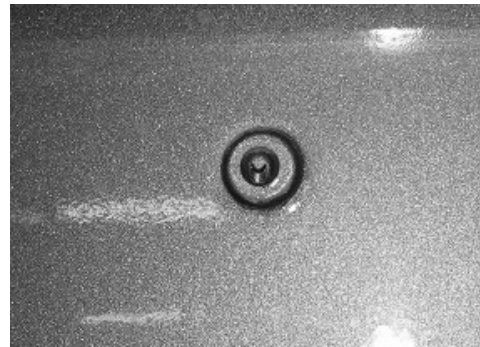

---

### SLIDEOUT ROOM RETRACTION (WITH POWER LIFT BED)

#### -If Equipped

Your coach may be equipped with a power lift/lower mechanism that raises and lowers the head of your bed to best suit your comfort needs.

This power lift/lower mechanism is equipped with an interlock feature, which will not allow you to retract the bedroom slideout unless the bed is in the fully upright position.

### NOTICE

Bed must be in the fully upright (vertical) position to fully retract slideroom.

**Further Information**

For further power bed operating instructions, refer to *Section 9 - Furniture and Softgoods* in this manual.

**SLIDEOUT ROOM OPERATION  
– ELECTRIC**

WARNING

Your motorhome may have more than one slideout room. Understand which switch operates which slideout room prior to operation. Make sure all slideout rooms are clear of people who could be harmed or obstacles that could cause damage prior to operating any slideout rooms. Failure to observe can result in death or serious injury.

Slideout rooms provide a spacious living area at the push of a button.

Slideout room switches are located either inside the cabinet above main entrance door or on the touch tablet. Location varies by model and floorplan.

Your coach may be equipped with a touch tablet to control the slideouts and travel locks in one convenient location.



**Front Slideout Switches**  
(Located inside entrance door overhead cabinet)

(Your coach may have one or more of these switches depending on model, options, and available equipment)

-Typical View

**To control Slideouts on Touch Tablet**



**Touch Tablet Main Menu**

- Tap on “Exterior” (selection displays in white).



**Slideout Room Switches**

(Located on touch tablet “Exterior” screen)

- Push and Hold to Extend or Retract slideout.
- Release to Stop.

-If Equipped

## SECTION 10 – SLIDEOUT ROOMS AND LEVELING

---

### CAUTION

Never drive the vehicle with a slideout room extended!

The slideout room system uses 12-volt DC motorized mechanisms with an electronic control system to provide smooth operation and positive weather seal.

*NOTE: We recommend that you KEEP THE ENGINE RUNNING WHILE EXTENDING OR RETRACTING SLIDEOUT ROOMS so the engine alternator can provide maximum power for proper operation of the slideout mechanisms. After initially starting a cold diesel engine the engine preheat grid may cycle on and off for up to 90 seconds, the cycling of the preheat grid will result in a momentary drop in chassis battery voltage that may cause a low voltage error in the slideout or leveling controller. If this happens, wait until the preheat grid is no longer cycling to operate your slide room and leveling jacks.*

### WARNING

CRUSH HAZARD. Keep people and objects clear of the inside and outside of the slideout room when operating. Failure to comply could result in death or serious injury.

## To Extend Slideout Room

### Before Extending!

- Level the coach and set the Parking Brake.
- Release the travel lock or latch (if equipped) inside the coach. *See information at beginning of this section (if equipped).*

- Ensure exterior compartment doors are closed so that they will not interfere with slideout operation.
- Ensure driver and co-pilot seat backs are clear of slideout trim before extending slideout.
- Check inside and outside the vehicle to make sure that there are no people who could be harmed or obstacles that could cause damage due to room extension.
- If the slideout room has a couch or other furniture, make sure no people or pets are seated on them until the room has been fully extended.

### NOTICE

Release slideout room travel latch before attempting to extend slideout room.  
Secure travel latch before driving vehicle.

### Extend Procedure:

*See “Before Extending!” before proceeding.*

- Engage the parking brake.
- Start the engine so the alternator can provide maximum power for proper operation of slideout mechanisms.
- Press the Slideout Room “EXTEND/OUT” switch and hold until the room is fully extended, then release the switch.
- To stop extending the room during operation, release the button.
- Remove and Securely store the Ignition Key.

## To Retract Slideout Room

### Before Retracting!

- Be sure the coach is level and the Parking Brake is set.
- Ensure exterior compartment doors are closed so that they will not interfere with slideout operation.
- Ensure driver and co-pilot seat backs are clear of slideout trim before retracting slideout.

- Check inside and outside the vehicle to make sure that there are no people who could be harmed or obstacles that could cause damage due to room retraction.
- Stow all furniture extensions before retracting slideout rooms to avoid property damage.
- If the slideout room has a couch or other furniture, make sure no people or pets are seated on them until the room has been fully retracted.
- Remove all items from the coach living room floor and close cabinet doors and drawers. Be sure there are no items at the end of the bed, behind the driver seat, or protruding from compartments, which could be crushed or cause damage to floor covering or cabinets when the room is retracted.

### NOTICE

Because the slideout roof is drawn into the interior of the coach when retracted, be sure there is no debris, such as excessive dirt, tree seeds, twigs, leaves, etc. on the roof before retracting.

If it has rained recently before you retract the slideout room, we recommend using the hydraulic leveling system (if equipped) to lean the coach and drain off any excess water possibly remaining on the roof before retracting. Lean the coach slightly to the left or right (depending on slideout location), by raising both right or left side jacks to let excess water flow away from the rooftop weather seal and toward the outside of the slideout roof. Retract the slideout slowly, starting and stopping to allow water to drain off room cover.

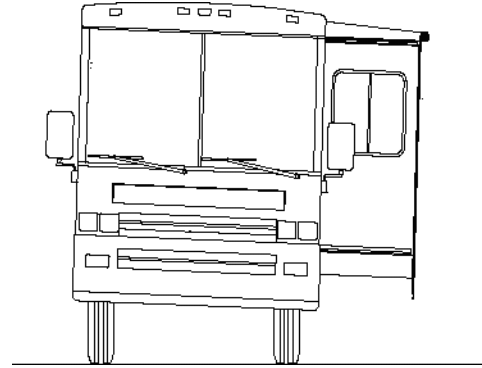

### Retract Procedure:

*See “Before Retracting!” before proceeding.*

- Engage the parking brake.
- Start the engine so the alternator can provide maximum power for proper operation of slideout mechanisms.
- Press the Slideout Room “RETRACT/IN” switch and hold until the room is fully retracted, then release the switch.
- To stop retracting the room during operation, release the button.
- After the room is retracted, Remove and Securely store the Ignition Key, then refasten the travel lock or latch inside the coach (if equipped).

---

---

### SLIDEOUT ROOM – EXTREME WEATHER PRECAUTION

Certain extreme weather conditions, such as heavy rains, heavy snow, and high winds, or any combination of these, could cause damage to the slideout room cover-awning (if equipped) or reduce effectiveness of the slideout room weather seals.

## SECTION 10 – SLIDEOUT ROOMS AND LEVELING



Slideout Cover-Awning  
-Typical View

Also, freezing rain and snow can prevent the slideout cover-awning (if equipped) from closing and may cause damage to the cover-awning, slideout room, weather seals, and mechanisms.

To avoid potential damage, we recommend retracting your slideout room during extreme weather conditions.

---

---

### SLIDEOUT ROOM TROUBLESHOOTING (POWER GEAR®) IN WALL SLIDEOUT

#### -If Equipped

#### Battery Voltage or Circuit Breaker Problems

##### If the slideout room will not work:

- Turn the Chassis Battery Disconnect switch OFF (leave off for 20 seconds) and then turn ON again. This will, in many cases, reset power to the slideout system.
- The chassis battery may be low on charge. Press and Hold the Battery Boost switch (located on the dash) while pressing the interior slideout control switch. This momentarily connects the house batteries to assist in slideout room operation.
- The circuit breaker may be tripped. The circuit breaker, labeled “Slideout Power” is located on a panel on an interior wall of the passenger side storage compartment just behind or ahead of the entrance door.

### Problems Retracting or Extending the Room



- Fault Code LED

Slideout Control Box  
(Located in a driver or passenger side compartment, depending on model)  
-Remove panel to access

If an error is detected on your slide system, the LED light on the control panel will blink an error code. If an error code appears, see the In Wall Slideout manufacturer’s user guide in your InfoCase to determine the problem. The error code must be cleared prior to operating the room.

#### Further Information

See the In Wall slideout room operating guide included in your InfoCase for further instructions and troubleshooting information.

---

---

### SLIDEOUT ROOM TROUBLESHOOTING (POWER GEAR®) UNDER FLOOR SLIDEOUT

#### -If Equipped

#### Battery Voltage or Circuit Breaker Problems

##### If the slideout room will not work:

- Turn the Chassis Battery Disconnect switch OFF and then ON again. This will, in many cases, reset power to the slideout system.
- The chassis battery may be low on charge. Press and Hold the Battery Boost switch (located on the dash) while pressing the



interior slideout control switch. This momentarily connects the house batteries to assist in slideout room operation.

- The circuit breaker may be tripped. The circuit breaker, labeled “Slideout Power” is located on a panel on an interior wall of the passenger side storage compartment just behind or ahead of the entrance door.

### Problems Retracting the Room

- Set the Park Brake if the Engage Park Brake light flashes while pressing the Retract (IN) button.

- Light will flash if park brake not set
- Light will flash fault code if system malfunctions



- Low Voltage Indicator

Slideout Touchpad  
(Located in cabinet above main entrance door or near systems monitor panel depending on model)  
-Typical View

If an error is detected on your slide system, the LED light on the control panel will blink an error code. If an error code appears, see the manufacturer’s user guide in your InfoCase to determine the problem. The error code must be cleared prior to operating the room. To clear the error and reset the system:

- If none of the “Battery Voltage or Circuit Breaker Problems” troubleshooting recommendations reset the system, remove the touchpad from the monitor panel (a screwdriver will be needed) and press and hold the RESET button (“Set Stops/Clear Fault”) located on the back of the touchpad for

5 seconds. The slideout is now ready to be retracted. Press IN on the touchpad to retract the room.

- Reinstall touchpad to the wall.
- Take your vehicle to an authorized service center for repair.

Before operating the room after an error has been detected, check for obvious faults such as obstructions prior to trying to operate the room again. If the error code appears again, the room will need to be retracted using either the manual retraction method or the fully manual method. Both methods listed below are intended as a means to retract the room to prepare the coach for travel to the nearest authorized service center.

### Manual Mode

Manual Mode lets you individually move the two room arms by pressing the IN and OUT buttons on the touchpad. *This mode can be used only if there is not a motor failure or full electrical system failure.* To override the encoder and enter the Manual Mode, press and hold the RESET button (“Set Stops/Clear Fault”) located on the back of the touchpad until the two LEDs begin to flash.

While in the Manual Mode, each of the two room slide arms are activated by pressing and holding the IN and OUT buttons. The “OUT” button will retract the front arm. The “IN” button will retract the back arm. Both IN and OUT buttons may be held down at the same time to simultaneously activate both arms to retract the room. If one side of the room gets ahead of the other, release that button until the other arm catches up. The current limiting feature of the control still functions in the Manual Mode so each side can be fully retracted until it stops.

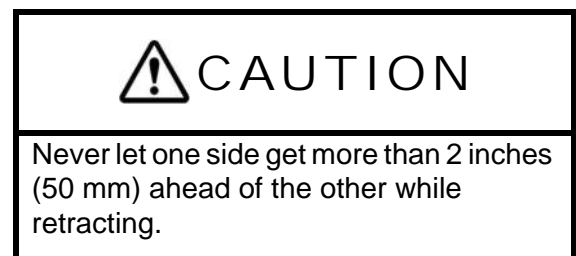

## SECTION 10 – SLIDEOUT ROOMS AND LEVELING

Once the room has been retracted, the control will return to the automatic mode after 60 seconds.

In the event of a total system failure where Manual Mode cannot be used, two crank handles may be used to retract or extend the room. See *Slideout Emergency Retraction* elsewhere in this section.

### Problems Extending the Room

- Set the Park Brake if the Engage Park Brake light flashes while pressing the Extend (OUT) button.

- Light will flash if park brake not set
- Light will flash fault code if system malfunctions



- Low Voltage Indicator

Slideout Touchpad  
(Located in cabinet above main entrance door or near systems monitor panel depending on model)  
-Typical View

If an error is detected on your slide system, the LED light on the control panel will blink an error code. If an error code appears, see the manufacturer's user guide in your InfoCase to determine the problem. The error code must be cleared prior to operating the room. To clear the error, perform the following steps (one at a time) to reset the system:

- If none of the "Battery Voltage or Circuit Breaker Problems" troubleshooting recommendations reset the system, remove the touchpad from the monitor panel (a screwdriver will be needed) and press and hold the RESET button ("Set Stops/Clear

Fault") located on the back of the touchpad for 5 seconds. The slideout is now ready to be extended. Press OUT on the touchpad to extend the room.

- If touchpad was removed, reinstall to the wall.
- Take your vehicle to an authorized service center for repair.

### Further Information

See the slideout room operating guide included in your InfoCase for further instructions and troubleshooting information.

---

---

## SLIDEOUT EMERGENCY RETRACTION (POWER GEAR®) IN WALL SLIDEOUT

### -If Equipped

If the slideout mechanism is malfunctioning and the room will not retract using the interior control switch, see the In Wall Slideout Room operating guide included in your InfoCase for further instructions and troubleshooting information.

---

---

## SLIDEOUT EMERGENCY RETRACTION (POWER GEAR®) UNDER FLOOR SLIDEOUT

### -If Equipped

If the slideout mechanism is malfunctioning and the room will not retract using the interior control switch, you may need to access the motor/gear assembly and manually crank the room in to the travel position.

Each front slideout room has two motor/gearbox units, which are located beneath each of the slideout room rails.

### Crank-In Procedure

- Disengage the motor brakes, which appear as a flat "square" protrusion on the protective boot at the end of each motor. Move the brake lever slightly – about 1/8 turn counter-clockwise (to left when facing end of motor).

- Disconnect the motor power lead from the wiring harness (repeat for motor at other end of room).

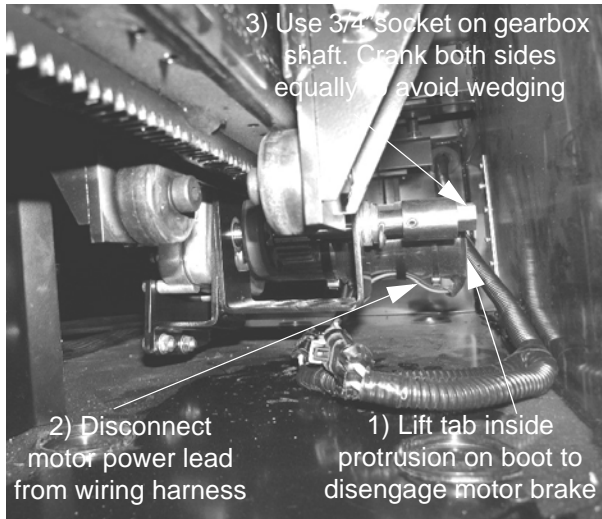

**Slideout Motor/Gear Assembly**  
(Located beneath each end of slideout room rail)

\* Shown with slideout room extended  
-Typical View

- Use a 3/4" socket and ratchet wrench on the motor gearbox shaft to crank the room in or out as needed. Crank both sides of the room alternately and equally to avoid wedging the room.  
If help is available, a second person (with a duplicate socket and ratchet) cranking the other end simultaneously will greatly speed up the process.
- Crank the room until it is just “snugged up.” Do not over-crank or you could damage the gear assembly.
- While maintaining pressure on ratchet wrenches, re-engage the motor brake by moving lever clockwise slightly (to right when facing end of motor).
- Reconnect motor power lead to wiring harness.
- Fasten slideout room travel latching device (if equipped) inside the coach before driving the vehicle.
- See your dealer for service of the slideout mechanism before using again.

## Further Information

See the Under Floor Slideout Room operating guide included in your InfoCase for further instructions and troubleshooting information.

---

---

## SLIDEOUT EMERGENCY RETRACTION – BEDROOM (POWER GEAR®)

### -If Equipped

If the slideout mechanism is malfunctioning and the room will not retract using the control switch, you may need to access the motor/gear assembly and manually crank the room in to the travel position.

The rear bedroom slideout has a motor/gearbox unit, which is located underneath the bed. Lift the bed board to access.

*NOTE: If the bed in your coach is equipped with the Power Lift feature, the bed must be lowered completely before lifting the bed board.*

### Crank-In Procedure

- Disengage the motor brake, which appears as a flat “square” protrusion on the protective boot at the end of the motor. Move the brake lever slightly – about 1/8 turn counter-clockwise (to left when facing end of motor).
- Disconnect the motor power lead from the wiring harness.
- Use a 3/4" socket and ratchet wrench on the motor/gearbox shaft to crank the room in.

## SECTION 10 – SLIDEOUT ROOMS AND LEVELING

---

- 1) Lift tab inside protrusion on boot to disengage motor brake

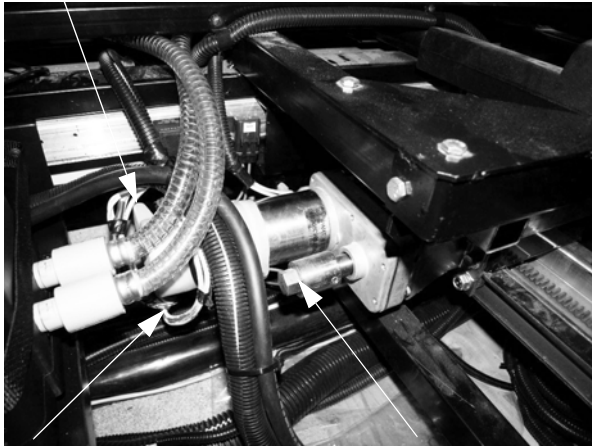

- 2) Disconnect motor power lead from wiring harness

- 3) Use 3/4" socket on gearbox shaft to crank room in

Rear Slideout Motor/Gearbox Unit  
(Located underneath bed)  
-Typical View

- Crank the room until it is just “snugged up.” Do not overcrank or you could damage the gear assembly.
- While maintaining pressure on ratchet wrenches, re-engage the motor brake by moving lever clockwise slightly (to right when facing end of motor).
- Reconnect motor power lead to wiring harness.
- Fasten slideout room travel latching device (if equipped) inside the coach before driving the vehicle.
- See your dealer for service of the slideout mechanism before using again.

### Further Information

See the slideout manufacturer’s user guide provided in your InfoCase for further instructions and troubleshooting information.

- Clean the floors inside the coach before retracting the slideout room to avoid floor scratches or carpet pile snags.
- Wipe outer slideout room seals occasionally with talc or 303 brand protectant for smooth, quiet operation.
- See your authorized dealer for regular maintenance and service of the slideout mechanism.

### Slideout Room Seal Care and Maintenance

While most household cleaners work well for cleaning slideout room seals, certain chemical agents may cause the seals to degrade. Typically, 409® and Lysol® type products work well. Use a product, such as Armor All® to keep seals soft.

In addition, certain caulks and sealers may include chemicals that may adversely effect the performance of the seals. See your authorized dealer for caulks and sealers recommended for your coach.

---

---

## LEVELING SYSTEM (HYDRAULIC)

### -If Equipped

The Hydraulic Leveling System makes selecting a parking site easier and faster by reducing the effect of uneven ground.

Hydraulic jacks raise the affected low corners of the coach to make leveling “set up” faster and easier for you.

The Hydraulic Leveling System Control Panel is located on the driver side trim panel.

**See the Leveling System Operation Guide provided in your InfoCase for complete operating instructions.** It also contains additional precautions, technical information, and instructions for manual operation if a system failure occurs.

---

---

## GENERAL SLIDEOUT CARE

- Keep slideout room seals clean.

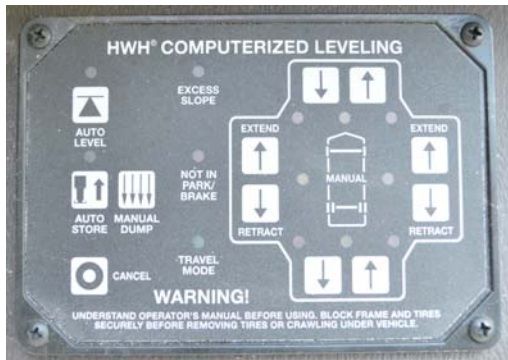

Hydraulic Leveling System Control Pad  
(Located on driver side trim panel)  
-Typical View

*NOTE: When parking at an uneven site, always park the front of the vehicle to the downhill side. This allows you to level by raising the front end rather than the rear. Since only the rear wheels are locked while in PARK, raising either one or both of the rear wheels off the ground could allow the vehicle to roll off the jacks.*



## WARNING

- Keep all people clear of the coach while the leveling system is operating.
- When extending the rear stabilizers, do not lift the wheels beyond ground contact. This makes it possible for the vehicle to roll unexpectedly forward (or backward) off the jacks. This could cause severe injury or death.
- Do not use the levelers on icy or slick surfaces on which the foot pads may slip.
- Do not use leveling jacks to support the vehicle for service or tire changing.
- Do not use the leveler as an emergency brake. They are not designed for any type of vehicle braking purpose.
- Never check for hydraulic fluid leaks using your hands and/or any other body part. The leaking fluid is under pressure and is capable of cutting and penetrating your skin, resulting in severe injury.

### Auto Level Remote Switches

In addition to the Leveling System Control Panel, there are two additional remote switches for your leveling convenience.

These switches allow you to extend or retract your jacks and observe them at the same time. It also allows you to stop them suddenly, if needed, without having to climb in and out of the coach.

The Auto Level Remote switches are located just inside the entrance door and in the exterior service center.

## SECTION 10 – SLIDEOUT ROOMS AND LEVELING

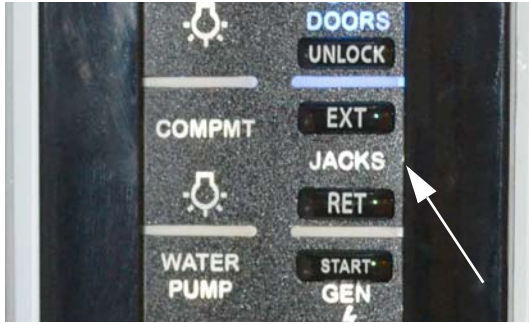

Auto Level Remote Switch

(Located near entrance door and/or inside exterior service center)

-Typical View

*The switch will illuminate blue when the switch is on. White illumination indicates the switch is off.*

### HWH® Master Warning Light

The “HWH® Master Warning” reminder is intended to warn you to retract your Hydraulic Leveling Jacks before moving the vehicle. The light will come on briefly and a chime will sound when the ignition key is turned to the On or Run positions if the hydraulic jacks are down.



HWH® Master Warning Light

(Located on dash)

-Typical View

### NOTICE

- Do not try to drive vehicle unless “TRAVEL” light is glowing with ignition switch on.
- Do not try to drive the vehicle until the air suspension system has built up sufficient pressure if you have used the coach leveling system or have used the DUMP button to manually exhaust the air suspension system.
- Do not rely only upon the warning lights to indicate when jacks are up. It is the owner’s responsibility to check that all jacks are up before moving the coach.

*NOTE: If the Leveling Jacks should fail to retract, see “Troubleshooting” and emergency operation instructions in the Leveling System Operation Guide provided in your InfoCase.*

### In The Event Of Accidental Jack Extension

1. Bring the vehicle to a safe and complete stop as soon as possible.
2. Turn the Leveling System Power switch ON, use the arrow “Down” button and select “Auto Retract”, and press Enter.
3. Visually inspect the vehicle undercarriage for any problems.
4. See the Leveling System Operation Guide supplied in your InfoCase for troubleshooting instructions or operating the Leveling System if jacks fail to retract or any other functions fail.

### Further Information

See the manufacturer’s operation guide provided in your InfoCase for complete operating instructions, safety precautions, and troubleshooting tips.

### LEVELING SYSTEM (AIR AND HYDRAULIC)

#### –If Equipped

*NOTE: See the Leveling System Operation Guide provided in your InfoCase for complete operating instructions. It also contains additional precautions, technical information, and instructions for manual operation if a system failure occurs.*



Air and Hydraulic Leveling System Control Pad and Leveling System Reset Switch

(Located on driver side trim panel)  
-Typical View

The Leveling System makes selecting a parking site easier and faster by reducing the effect of uneven ground.

Hydraulic jacks raise the affected low corners of the coach to make leveling “set up” faster and easier for you.

Air Leveling uses the chassis air suspension to level the coach. To lower the coach, air is released from the suspension air bags. To raise the coach, air is added to the suspension air bags.

***Before using the Air Leveling feature, be sure to read the Air Leveling System Operator’s Manual provided in your InfoCase.***

The Leveling System Control Panel is located on the driver side trim panel.

*NOTE: When parking at an uneven site, always park the front of the vehicle to the downhill side. This allows you to level by raising the front end rather than the rear. Since only the rear wheels are locked while in PARK, raising either one or both of the rear wheels off the ground could allow the vehicle to roll off the jacks.*



#### WARNING

- Keep all people clear of the coach while the leveling system is operating.
- When extending the rear stabilizers, do not lift the wheels beyond ground contact. If the rear tires do not contact the ground it is possible for the vehicle to roll unexpectedly forward (or backward) off the jacks. This could cause severe injury or death.
- Do not use the levelers on icy or slick surfaces on which the foot pads may slip.
- Do not use leveling jacks to support the vehicle for service or tire changing.
- Do not use the leveler as an emergency brake. They are not designed for any type of vehicle braking purpose.
- Never check for hydraulic fluid leaks using your hands and/or any other body part. The leaking fluid is under pressure and is capable of cutting and penetrating your skin, resulting in severe injury.

## SECTION 10 – SLIDEOUT ROOMS AND LEVELING

### Auto Level Remote Switches (Hydraulic Leveling System only)

In addition to the Leveling System Control Panel, there are two additional remote switches for your hydraulic leveling convenience.

These switches allow you to extend or retract your hydraulic jacks and observe them at the same time. It also allows you to stop them suddenly, if needed, without having to climb in and out of the coach.

The Auto Level Remote switches are located just inside the entrance door and in the exterior service center.



Auto Level Remote Switch  
(Located near entrance door and/or inside exterior service center)  
-Typical View

*The switch will illuminate blue when the switch is on. White illumination indicates the switch is off.*

### HWH® Master Warning Light

The “HWH® Master Warning” reminder is intended to warn you to retract your Hydraulic Leveling Jacks before moving the vehicle. The light will come on briefly and a chime will sound when the ignition key is turned to the On or Run positions if the hydraulic jacks are down.

With the Air Leveling system, the “HWH® Master Warning” will come on and a chime will sound if any suspension air bag has less than 20 PSI, the coach air supply is less than 85 PSI, or anytime the HWH® system has control of the air suspension (leveling, dump, and raise).



HWH® Master Warning Light  
(Located on dash)  
-Typical View

### NOTICE

- Do not try to drive vehicle unless “TRAVEL” light is glowing with ignition switch on.
- Do not try to drive the vehicle until the air suspension system has built up sufficient pressure if you have used the coach leveling system or have used the DUMP button to manually exhaust the air suspension system.
- Do not rely only upon the warning lights to indicate when jacks are up. It is the owner’s responsibility to check that all jacks are up before moving the coach.

*NOTE: If the Leveling Jacks should fail to retract, see “Troubleshooting” and emergency operation instructions in the Leveling System Operation Guide provided in your InfoCase.*

### In The Event Of Accidental Jack Extension

1. Bring the vehicle to a safe and complete stop as soon as possible.



2. Turn the Leveling System Power switch ON, use the arrow “Down” button and select “Auto Retract”, and press Enter.
3. Visually inspect the vehicle undercarriage for any problems.
4. See the Leveling System Operation Guide supplied in your InfoCase for troubleshooting instructions or operating the Leveling System if jacks fail to retract or any other functions fail.

### Further Information

See the manufacturer’s operation guide provided in your InfoCase for complete operating instructions, safety precautions, and troubleshooting tips.

---

---

### CHECKING HYDRAULIC OIL LEVEL (HWH®)

See the Leveling System Operator’s Manual in your InfoCase for complete maintenance instructions and information.

All maintenance should be done as part of the normal servicing of the coach.

The hydraulic oil level should be checked when the vehicle is first purchased, and then twice a year - or more often if an oil leak develops in the system.

The hydraulic pump is located behind a compartment door on the driver side near the front of the coach.

### Jacks Positions

To get an accurate indication of oil level:

- Leveling Jacks must be UP

### Checking Dipstick

The hydraulic oil level is checked with a dipstick built into the breather/filler cap on top of the oil reservoir, which is part of the hydraulic pump/manifold assembly.

*NOTE: Always clean away any dirt and debris from the top of the reservoir before removing the breather cap to avoid entry*

*of debris and contamination of hydraulic oil in the reservoir, which could lead to pump failure or other problems.*

The oil level should be between the two marks on the breather cap dipstick shown in the following photo.

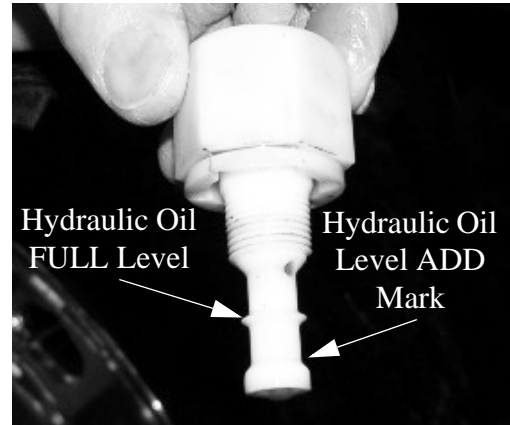

Hydraulic Oil Breather Cap/Dipstick  
-Typical View

*NOTE: Overfilling the hydraulic reservoir can cause leakage of oil through the breather cap.*

### Hydraulic Fluid Recommendation

HWH® specialty hydraulic fluid or Dexron® III automatic transmission fluid is recommended for use in this system.

**DO NOT USE** brake fluid or hydraulic jack oil, which can damage the seals and cause leaks.



# SECTION 11 – MAINTENANCE AND STORAGE

---

---

---

## SEALANTS – INSPECTION AND GENERAL INFORMATION

Water is a recreational vehicle’s worst enemy when it is allowed to enter where it is not intended. Sealants perform a very important function and should be inspected closely and maintained regularly. Winnebago Industries® utilizes many different types of sealants. Refer to the “Sealants Call-Out Sheet” provided in your InfoCase for further information.

Sealants, in general, do not have “set” lifetimes. Varying environmental factors affect the pliability and adhesiveness of sealants. You or your dealer must:

- Inspect all sealants, a minimum of every six months.
- Inspect the moldings, windows, clearance lights, exterior compartment doors, and all their attachments.
- Also, inspect weather seals around entrance door, etc., and if necessary, have a dealer replace them immediately.
- Check for cracks, voids, gaps, breaks, adhesion, and any sign of physical deterioration.

*NOTE: Proper sealant inspection includes not just visual observation but running a finger along sealant seams to verify proper adhesion to the surface. Any loosened areas must be replaced.*

- Have the sealant replaced if you notice any of the above. Your local Winnebago Industries dealer has the correct and necessary parts and experience to help you maintain your sealants. See “Sealants Call-Out Sheet” provided in your InfoCase.
- Always use the same type sealant that was removed.
- Immediately have dealership check moldings, windows, and exterior attachments for leak source if you notice water inside of unit.

### NOTICE

Sealants must be inspected every 6 months and replaced if necessary.

---

---

## ROOF



### WARNING

STAY OFF ROOF. Surface may be slippery. Falling could result in death or serious injury.

The roof is made of Thermo-Panel materials like the walls and floor. It will support the weight of an average adult for periodic maintenance or repair of the roof or roof mounted components.

Walking or working on the roof should be left to qualified service personnel using proper safety equipment in a safe environment. You should only walk or work on the roof if you are qualified and have created a safe environment.

For your safety, it is not recommended that you store or carry items on the roof.

Always have damage to the roof area repaired immediately. Damaged or detached sealant around the vents, air conditioner, body-to-roof seams, etc., should also receive immediate attention. Delaying these repairs may allow water leakage and result in damage to interior ceiling and body panels, upholstery, etc., which is not covered by the limited warranty (see” New Vehicle Limited Warranty” provided at the beginning of this manual).

---

---

## UNDERCARRIAGE

Buildup of mud and dirt under the body of the vehicle can cause damaging rust or corrosion on steel or aluminum parts and can add needless

## SECTION 11 – MAINTENANCE AND STORAGE

---

weight to the vehicle. This, in effect, reduces the amount of cargo you can carry and remain within GVWR and GAWR limits.

Corrosive materials, such as those used for ice and snow removal and dust control, can also accumulate on the underside of a vehicle. These materials should be removed by flushing the undercarriage regularly with water, especially horizontal surfaces, cavities, and other areas where mud and other deposits may collect.

---

---

### EXTERIOR AUTOMOTIVE PAINT FINISH

The body of your coach is fully or partially finished with the highest quality automotive paint and clearcoat. Follow these precautions to keep the finish on your coach looking its best and preserve maximum gloss and durability.

#### Parking

- **Avoid parking under trees** – When this happens you should rinse the bird droppings and tree sap off as soon as possible. Tree sap is a form of sugar and will dissolve after a couple of rinses. Bird droppings can eat into a painted surface if left unattended and need removed as soon as possible. Lukewarm soapy water can help speed up the cleaning process.
- **Avoid parking near salt spray** – When this happens you need to rinse off the salt mineral residue to minimize the corrosiveness of the salt.
- **Avoid parking near factories with heavy smoke or industrial fallout** – Industrial fallout can eat into your coaches finish when dew or rain mixes with it to create nitric or sulfuric acid that gets magnified by the intensity of the sun. As the water evaporates, the acid becomes more powerful and attacks the painted surface.  
Rinsing and washing the surface helps remove the fallout and neutralize the acid. After the initial 60-day cure stage, a coat of wax or polish can help protect the surface from these types of contaminants.

- **Do not scrape ice or snow from the painted surface.** Brush off gently with a soft-bristled snow brush – avoid being forceful with the brush.  
If brush scratches show after the motorhome thaws out, it may be possible to remove them by hand waxing with a silicone-free liquid wax.
- **Avoid covering painted surface.** When paint is covered (especially in outdoor conditions), water may appear between the cover and the vehicle due to rapid temperature fluctuations. The water may vaporize under certain conditions and migrate into the painted surface, possibly resulting in blisters and/or bubbles in the paint. These blisters/bubbles are not covered under warranty.  
Covering your RV is at owner's risk.

#### Driving

- Avoid driving on gravel roads.
- Rinse off bugs and bird droppings with water daily.
- Antifreeze, fuel, or windshield/window solutions spilled on the painted surface should be rinsed off immediately with water and allowed to air dry. Wiping dry with a towel may create fine scratches due to the solvent nature of these types of fluids.
- Fuel cannot be diluted and dissipated with water. It must be removed with a mineral spirit type cleaner (such as *SEAFOAM Bugs-B-Gone*, or equivalent) or a silicone-free spray wax and microfiber cloth to remove the stain left by fuels.
- Ensure that all RV fluids (such as gas, oil, grease, antifreeze, transmission fluid, brake fluid, etc.) are completely wiped off of painted surfaces. Failure to comply may cause the paint to blister and/or peel.

*NOTE: When driving in wintry conditions, the road surface may be covered with heavy salts or small rocks to improve road traction. These types of road conditions can cause undue surface damage to your RV. Please refrain from driving in these conditions.*

## **Washing**

- Commercial vehicle wash facilities should be strictly avoided! They will scratch your RV!

*Truck-style wash centers have high-pressure wands that emit higher than necessary water pressures and the brushes are very aggressive.*

*Most truck wash brushes are made from a heavy plastic for durability and are under heavy pressure. They are designed to clean heavy road films on semi trailers and are often dirty. They are not designed for custom painted RV's and they will scratch the clearcoat finish.*

*Many times these scratches can penetrate the clearcoat finish, possibly causing delamination and/or other paint related issues that are not covered under warranty.*

- Wash your RV with cool or lukewarm water using a quality automotive detergent that does not contain bleach solution. Most auto stores offer car wash detailing soaps that are similar and do not have bleach in the formulation (such as Meguiars #62).
- Never use a bristled brush or broom to wash the painted surface. This will cause scratches in the finish. Using a microfiber cloth, mitt, or mop is strongly recommended.
- Be sure your cloth or applicator is clean. A dirty applicator can scratch your RV.

## **Washing Procedure**

- Rinse area to be washed with cold water to remove surface residue. Ensure you are not in direct sunlight.
- With area to be washed still wet from the rinse, use the recommended soapy mixture to clean the area. To avoid scratching painted surfaces, a microfiber cloth, mitt, or mop is strongly recommended to apply soapy water.
- Rinse washed area before soap evaporates.
- Dry the rinsed area before the water evaporates.

*NOTE: Avoid aiming water flow from a hose or spray from high-pressure washing equipment into any appliance intake, as damage or difficulty in operating appliances may occur.*

- After washing the coach, carefully inspect sealant around window frames, vents, and any other joints that may have loosened or separated. See “Sealants - Inspection and General Information” at the beginning of this section for details.

## **Bug Removal**

- Rinse any loose debris off with water and allow the remaining residues to soak and soften. Use soap and water to wash the residue, then rinse.

*NOTE: You may wish to repeat and leave soap on longer than normal to help with softening hardened residue.*

- For more stubborn areas, use an ammonia-based glass cleaner followed by washing with warm soapy water, then rinse.
- Remember to use microfiber towels during this process to help avoid scratches.
- If this does not work, as a last resort, use a bug removal product (like SEAFOAM Bugs-B-Gone, or equivalent) in a shady area and follow the directions on label. Ensure cleaner is completely wiped off of painted surfaces. Failure to comply may cause the paint to blister and/or peel.

## **Polishing and/or Waxing**

*NOTE: When your coach is new or has been repainted for any reason, no polish or wax should be applied to the finish until after a 60-day cure cycle at temperatures higher than 60 degrees for 60 days. Failure to observe this precaution could void your paint warranty.*

- We recommend a silicone-free polish with an orbital machine and terry cloth applicator.
- Liquid waxes are easier to apply and bring to a gloss with fewer residues.

## SECTION 11 – MAINTENANCE AND STORAGE

---

- Avoid paste waxes. They sometimes have fillers and additives that give a very short term result. Stay away from silicones in polishes and soaps.
- Buffing compounds remove some of the mil film of the clearcoat, so we recommend that only professionals or very experienced users apply this type of product.

### Inspection

A motorhome exterior is subjected to many physical forces and environmental conditions. While the coach is parked, it is exposed to climate and weather extremes and other environmental conditions. While in operation, it is subjected to various twisting and flexing forces caused by routine cornering and turning, and by uneven road surfaces, such as bumps, potholes, railroad tracks, and parking lot entrances.

Inspect the exterior fiberglass shell periodically for cracks which may represent a threat to the integrity of the fiberglass.

Minute cracks in the surface (commonly referred to as "spider cracks" or "hairline cracks") caused by normal flexing of the fiberglass exterior are normal and typically pose no threat to the integrity of the vehicle other than appearance.

However, if a crack has opened up and the weave of the cloth is visible, this does represent a threat to the integrity of the fiberglass and must be repaired or covered as quickly as possible to avoid penetration by moisture, especially in freezing climates.

If the fiberglass has been damaged and contains cracks, tears, or holes, use plastic sheeting and duct tape, if necessary, to prevent moisture from damaging the sidewall material or the interior of the coach.

### Protective Film –If Equipped

Your coach may be equipped with a protective film to defend against everyday road hazards. This film creates a barrier against bugs, road grime, bird droppings, and other harmful elements.

### Further Information

See the manufacturer's information provided in your InfoCase for complete care and maintenance instructions.

---

---

## EXTERIOR GRAPHIC CARE

The pressure-sensitive graphics on your vehicle require very little maintenance. In order to allow the graphics to have the longest life possible, the following steps should be taken.

- Wash graphics with plain soap and water or any car wash detergent. Rinse thoroughly.
- High pressure water spray may loosen or damage graphics. Keep spray nozzle at least 1 1/2 feet from the edge of the graphics.
- Test any cleaning solution on a small section of graphic before using.
- Never use aromatic solvents such as acetone, M.E.K., toluene, paint thinner or lacquer thinner on graphics. Solvents may soften the vinyl and smear colors.
- Gasoline or other fuels spilled on graphics should be rinsed off immediately with water.
- Do not apply paint or clearcoat over the graphics.
- Do not apply wax over the graphics, especially wax containing petroleum distillates. Wax that has dried along the edge of a graphic can be removed with cotton swabs after softening it with isopropyl alcohol. Rinse area thoroughly after cleaning.

---

---

## FRONT END MASKS AND PAINT DAMAGE

*NOTE: This information is to make you aware of a potential paint failure that could occur when moisture is trapped between front end masks and painted surfaces.*

If you choose to install an aftermarket protective front end mask, please follow these preventive guidelines:

- The front end mask must be removed if the vehicle sits longer than 5 days without being driven.

- The front end mask must be thoroughly dry before storing or reinstalling on the front of the vehicle.
- When reinstalling the mask, ensure both the mask and the painted surface are free of debris to avoid damage by abrasion.
- Failure to follow recommendations will void any paint warranty.

---

---

## HEADLIGHTS AND EXTERIOR LIGHTS

### Exterior Light Lenses

Most Winnebago Industries® vehicles have polycarbonate lenses on exterior lamps, which are very sensitive to a variety of chemical solvents and cleaners.

Use only soap and water to clean exterior lamp lenses - especially headlights.

- Contact with certain chemicals can cause etching, “crazing”, or cracking of the lens, which can significantly reduce the lens clarity and effectiveness of the lamp and may require replacement of the complete lamp housing.
- Some popular citric acid cleaners may cause bicarbonate lenses to become “hazy” or “foggy”.
- Do not use a pressure washer to clean headlights.
- Inspect and operate the lights regularly to confirm proper operation and mounting condition.

### Headlight Moisture

Your coach is equipped with composite headlights, which contain replaceable halogen “bulb” elements, common to most current automobiles. This type of lamp assembly is not sealed from the atmosphere and is designed with a moisture venting system.

Because they are not sealed, under “dew point” conditions the headlights may exhibit signs of humidity condensation on the reflector surface and lens, such as small droplets of water or “fogging over”.

If this happens, drive with the headlights on so the moisture can evaporate and expel through the venting system designed into the headlamp assembly.

---

---

## PLASTIC PARTS – CLEANING

Many parts in your vehicle, such as the dash, exterior light lenses, and certain exterior body panels are made of high-impact plastic materials that can be damaged by wiping with solvents or improper cleaning products.

Always try cleaning plastic parts with the mildest cleaners first and work your way up to stronger cleaning products. Use the following cautionary lists as a guide when selecting cleaning products to use on plastic parts.

NOTICE
Do not use citrus-based cleaners on polycarbonate finishes. Citric compounds will damage the high-gloss surface, causing it to appear dull or “flat”. Always test a cleaning product on a hidden area to be sure it will not cause damage to the appearance of the part.

Here is a list of mild cleaners that **may be used safely**:

- Car washing soap and water
- Glass cleaners *without ammonia*
- Mineral oil
- Multipurpose cleaners (such as Fantastik®, Formula 409®, etc.)

The following products, compounds, or solvents must be **wiped off immediately** to avoid damage:

- Ammonia
- Brake fluid
- Bathroom basin, tub, and tile cleaners
- Chlorine
- Ethyl alcohol
- Isopropyl (rubbing) alcohol

## SECTION 11 – MAINTENANCE AND STORAGE

---

- Kerosene or gasoline
- Naphthalene
- Pine-type household cleaners

**Do not use** cleaners containing the following products, compounds, or solvents. These products **will damage** the finish.

- Acetic acid
- Acetone (nail polish remover)
- Aromatic solvents (lacquer thinners)
- Benzene
- Butyl alcohol

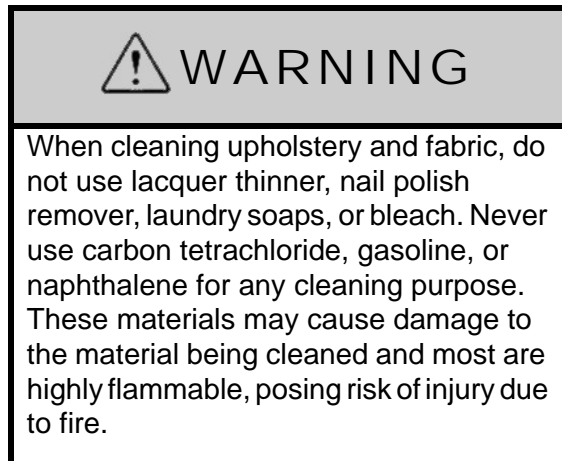

---

---

### INTERIOR SOFT GOODS

We recommend a weekly routine of vacuuming all fabrics and carpet throughout the motorhome to prevent an accumulation of dirt, which can detract from the appearance and shorten the life of carpet and fabrics.

#### Fabric Upholstery

Some fabrics used in this motorhome may contain fire retardant and lightfastness additives, which can be damaged by use of improper cleaning products. Some water-based household cleaning products are not formulated for use on fabrics and may cause excessive shrinkage or fading. Always test any cleaning product on a hidden area of fabric before using on visible areas. For best results, fabric cleaning should be referred to a professional carpet and upholstery cleaner.

*NOTE: To minimize fading of upholstery, carpets and other interior fabrics caused by excessive sunlight, the drapes, blinds, or shades should be closed when the motorhome is parked for an extended period of time.*

#### Ultraleather™ Leather-Like Upholstery

Ultraleather synthetic leather fabric material has the luxurious look and feel of the finest European calfskin, with the durability and resistance to soils and stains of vinyl fabrics. It is also tougher than real calfskin and has superior resistance to punctures, snags, and rips.

For most soils and stains, the fabric manufacturer recommends spot treatment with a solution of water and Tide® brand laundry detergent or equivalent. More stubborn stains may be treated with a water-based multipurpose cleaner/degreaser such as Simple Green® or equivalent. Solvent cleaners such as nail polish remover or other aromatic solvents are not recommended.

#### Care Instructions

- Spot clean with mild soap and water.
- Air dry or, if desired, dry quickly using a hair dryer on warm setting - not hot.
- For stubborn stains, use cleaner-degreaser.



<b>UltraLeather Cleaning Chart</b>		
<b>Type of Stain</b>	<b>Detergent/ Water</b>	<b>Cleaner/ Degreaser</b>
Coffee, Tea	◆	
Red Wine, Liquor	◆	
Cola, Soft Drinks	◆	
Milk	◆	
Ketchup	◆	
Steak/Soy Sauce	◆	
Mayonnaise, Butter	◆	◆
Salad Oil	◆	◆
Chocolate	◆	◆
Cosmetic Makeup	◆	◆
Lipstick	◆	◆
Face Cream	◆	◆
Suntan Oil/Lotion	◆	◆
Shoe Polish	◆	◆
Urine	◆	◆
Machine Oil		◆

### **Vinyl Fabrics (including ceiling)**

Vinyl should be cleaned with a soft, damp cloth, and a mild detergent only. Do not use solvents. Solvents may damage the surface of the vinyl.

### **Draperies, Curtains, and Bedspreads**

These items may be woven from a variety of fabrics. We recommend that these be professionally dry cleaned only. A five percent shrinkage may occur when you have these items dry cleaned.

### **General Stains**

As with any stain or contamination, the quick response is the best, especially when done in conjunction with the proper cleaner for the type of stain.

---



---

## **CABINETRY – CLEANING**

Wooden items may be cleaned with a soft cloth and a good quality wood finish cleaning product.

Vinyl simulated wood panels may be cleaned with a mild, water-based cleaner and a soft cloth. Do not use solvents on vinyl wood panels.

*NOTE: Many cabinetry and furniture items throughout this motorhome are constructed either partially or completely of real hardwoods. Because of natural variations in woodgrain density, slight differences in stain hue may exist between one item and another. This is the distinctive character and beauty of real wood.*

---



---

## **DECORATIVE VINYL WALL PANELING – CLEANING**

Decorative Vinyl Wall Paneling may be cleaned with mild detergent and warm water. The soap product should contain no abrasives, and the use of a soft cloth or sponge with the cleaning liquid should help preserve the finish of the vinyl.

Do not use bleach, cleaning agents with solvents or harsh chemicals, oil based spray cleaners, or other multipurpose cleaners such as Fantastik® or Formula 409® as they could damage the vinyl surface.

---



---

## **SOLID SURFACE COUNTERTOP – CORIAN®**

### **Care and Maintenance**

You can easily maintain the beauty of your countertop with little effort, under most circumstances, by using warm soapy water or an ammonia-based cleaner (not window cleaner) then rinse and wipe dry. You can also use liquid or gel-type cleaners containing bleach. Because the material is nonporous, stains cannot penetrate below the surface and will nearly always disappear using these cleaning methods.

**If a stain has dried on,** allow the cleaner or soapy water time to soften the area, after which the stain will wipe off.

## SECTION 11 – MAINTENANCE AND STORAGE

---

**If the stain is not water-base or oil-base** material, you may need to gently remove it using a plastic scraper (disposable plastic knife for example) followed by normal cleaning methods described above.

**You may want to scrub** the entire surface periodically. Do this lightly and evenly with a mild abrasive powdered or liquid cleaner.

**Always use a cutting board** rather than slicing foods directly on your countertop. The underside of one of your sink covers will provide an easily accessible cutting surface. This will keep your countertop looking its best and minimize care efforts. (An occasional sanding with a medium grade (120 grit) sandpaper will remove any cut marks accumulated on the sink cover bottom).

**To remove cuts and scratches**, use a more aggressive cleaning powder such as Comet<sup>®</sup>, a moistened steel wool soap pad, or green scouring pad. We recommend that you finish the entire surface using the same cleaning material and scrubbing method to maintain a uniform appearance.

**If you prefer a glossier look**, follow up with a good quality furniture polish or a liquid automotive wax (non-cleaner type).

**Use trivets and “hot pads”** under hot cooking pans. Do not set hot pots or pans directly from the stove or oven onto the counter. The solid surface material is extremely heat resistant, but sudden contact by a very hot material with a cold countertop surface could cause a crack that would need to be repaired. Likewise, concentrated high heat sources in a small area, such as a crock pot or an electric griddle may cause a crack. We strongly recommend using a trivet under these. Also, do not allow candles to burn directly on the counter surface.

**Avoid paint remover or oven cleaner.** The solid surface material is also resistant to most chemical substances but exposure to some harsh chemicals and solvents such as these can cause damage that would need professional repair or replacement. If one of these materials does spill or drip onto the counter surface, wipe it up immediately to avoid damage.

---

---

### SOLID SURFACE COUNTERTOP – QUARTZ

#### –If Equipped

You can easily maintain the beauty of your countertop with little effort by routinely wiping with a damp cloth or paper towel. Because the material is non-porous, stains cannot penetrate below the surface and will nearly always disappear using these cleaning methods.

#### Care and Maintenance

- **Clean routinely** with a damp cloth or paper towel and, if necessary, a small amount of non-bleach, non-abrasive cleanser.
- **Wipe up food and liquid spills** as soon as possible to avoid permanent staining.
- **For stubborn or dried spills**, use a nonabrasive cleaning pad such as a white 3M Scotch-Brite<sup>®</sup> scrub pad with Formula 409<sup>®</sup> Glass and Surface Cleaner or a comparable cleaning product. Rinse thoroughly with warm water to remove any cleaner residue.
- **To remove materials that harden as they dry** (such as gum, food, grease, nail polish or paint), you may need to gently remove it using a plastic scraper (disposable plastic knife for example) followed by normal cleaning methods described above.
- **Quartz countertops do not require sealants or waxes.** Quartz countertops keep its lustrous gloss and ultra-smooth surface without polishing or applying sealant.
- **To remove cooking grease** use Greased Lightning<sup>™</sup> or a comparable degreasing product to help loosen and remove the grease from the surface. Follow the cleaner manufacturer’s instructions for use.
- **If permanent marker does not come off with routine cleaning**, use Goo Gone<sup>®</sup>, or a comparable product, and rub it into the stain. Rinse thoroughly with warm water to remove any cleaner residue.

## **Preventing Damage**

- **Always use a cutting board** rather than slicing foods directly on your countertop. This will keep your countertop looking its best and minimize care efforts.
- **Use trivets and “hot pads”** under hot cooking pans. Do not set hot pots or pans directly from the stove or oven onto the counter. The solid surface material is extremely heat resistant, but sudden contact by a very hot material with a cold countertop surface could cause a crack that would need to be repaired. Likewise, concentrated high heat sources in a small area, such as a crock pot or an electric griddle may cause a crack. We strongly recommend using a trivet under these. Also, do not allow candles to burn directly on the counter surface.
- **Keep strong chemicals and solvents** (such as paint removers, furniture strippers, nail polish remover, bleach, bluing, permanent markers or inks, and oil soaps) **away from your countertop.**

---

---

## **STAINLESS STEEL APPLIANCES**

### **–If Equipped**

### **Care and Maintenance**

You can easily maintain the beauty of your stainless steel appliances with little effort, under most circumstances, by performing the following recommendations.

Typically, excellent results can be obtained by washing stainless steel with mild dishwashing liquid and hot water, followed by rinsing thoroughly and drying with a soft cloth. Drying is particularly important if the tap water is very hard and leaves scale deposits.

Stainless steel does not deteriorate due to frequent cleaning, so proper cleaning can be performed whenever necessary. For more stubborn stains, perform the following procedures for your stainless steel appliances to start shining again.

### **Scale**

To remove scale left by water, simply use a multipurpose cream detergent and a soft cloth. Thicker scale may be removed by generously applying 25% vinegar and hot water solution to the stain. Rinse thoroughly with a sodium bicarbonate and water solution, then follow up by rinsing with water. Clean carefully.

### **Oil and Grease Stains**

To remove oil and grease stains, use a mild dishwashing liquid and hot water. Rinse thoroughly with clean water and dry with a soft cloth. For more stubborn stains, ethyl alcohol, acetone, or another non-halogenated solvent may be used with care.

### **Stubborn Dirt and Burnt Grease**

Use a multipurpose cream detergent and a soft cloth.

### **Coffee and Tea Stains**

Prepare a sodium bicarbonate solution and hot water. Apply generously to stain and let sit for 15 minutes. Rinse thoroughly and dry with a soft cloth.

### **Rust Stains**

Apply a multipurpose cream detergent and rub delicately with a soft cloth. If stain persists, it may be necessary to apply a stainless steel-specific product.

### **Fingerprints**

Use a mild dishwashing liquid and warm water. Rub delicately with a soft cloth. Window cleaner may also be used.

### **Scratches**

Apply a stainless steel-specific detergent/polisher and buff with a soft cloth.

### **Important “Don’ts”**

- Do not use hydrochloric acid or any other detergents containing chlorides on stainless steel.
- Do not use abrasive powder detergents that could ruin the surface finish.

## SECTION 11 – MAINTENANCE AND STORAGE

---

- Do not use wool, abrasive brushes, or tools that have previously cleaned other metals, because as well as scratching the surface, they can generate contamination and unattractive stains.
- Do not use silver cleaners.

---

### SINK – STAINLESS STEEL

#### Care and Cleaning Instructions

The stainless steel sink can usually be cleaned with water and soap or detergent using a soft cloth or sponge.

- **Rinse thoroughly** with warm water and wipe dry quickly to avoid spots and streaks.
- **For stubborn stains**, use a mild abrasive cleanser like Soft Scrub<sup>®</sup>, Comet<sup>®</sup>, etc. Work in the direction of the “grain” of the brushed finish lines.
- **Never use steel wool.** Particles of steel from the wool pad can embed into the sink surface, then become rusty and unsightly.
- **Avoid contact with full-strength** bleaches, household chemicals, and acid-based cleaners. If this happens, rinse and wipe dry quickly.
- **Salt, mustard, and mayonnaise** can cause pitting if left on the steel sink surface. If spilled, clean and rinse immediately.
- **A high iron content** in the water (hard water) may result in a brown or rust-colored stained appearance. If noticed, dry towel sink after each use.
- **Do not use rubber mats** in the sink bowl. Material trapped under mats can complicate cleaning.

*NOTE: Improper use may damage this product and void the warranty.*

---

### RANGE AND REFRIGERATOR

For care and appearance maintenance of the range and refrigerator, refer to the appliance manufacturer’s operation and maintenance manuals included in your InfoCase.

---

### CERAMIC TILE – POLISHED

#### Care and Maintenance

You can easily maintain the beauty of your polished ceramic tile flooring with little effort, by routinely cleaning with an everyday cleaner, such as Aqua Mix<sup>®</sup> biodegradable concentrated stone and tile cleaner.

When used regularly, this neutral cleaner prevents soap scum and hard water deposits, along with leaving your coach smelling fresh and clean.

*NOTE: Before use, test a small area according to the application instructions. Read entire label before using.*

- Sweep, vacuum, or dust surface.
- Apply solution to surface with mop or sponge (see Aqua Mix label for concentration to water parts recommended).
- Allow solution to dwell 1 to 2 minutes.
- Agitate with a natural-bristle brush or white nylon scrub pad. Do not allow solution to dry on surface.
- Mop up dirty solution.

---

### BATHROOM

#### Toilet

For instructions on the care of your toilet, refer to the information in your InfoCase.

#### Tub and Shower Walls – Fiberglass –If Equipped

The tub and shower walls in the bathroom should be cleaned with mild soap and warm water. Do not use an abrasive cleaner on the tub and shower walls, as scratching and discoloration may occur. Stubborn stains may be removed with an automotive-type cleanser.

After cleaning, you can return the soft glow to your tub and shower walls by applying a light application of an automotive-type wax.

## **Shower Walls – Corian®**

### **–If Equipped**

You can easily maintain the beauty of your shower walls with little effort, under most circumstances, by using warm soapy water or an ammonia-based cleaner (not window cleaner) then rinse and wipe dry. You can also use liquid or gel-type cleaners containing bleach. Because the material is nonporous, stains cannot penetrate below the surface and will nearly always disappear using these cleaning methods.

**You may want to scrub** the entire surface periodically. Do this lightly and evenly with a mild abrasive powdered or liquid cleaner.

**If a stain has dried on**, allow the cleaner or soapy water time to soften the area, after which the stain will wipe off.

**To remove cuts and scratches**, use a more aggressive cleaning powder such as Comet®, a moistened steel wool soap pad, or green scouring pad. We recommend that you finish the entire surface using the same cleaning material and scrubbing method to maintain a uniform appearance.

## **Lavatory Sink**

Do not use abrasive cleaners, harsh detergents, or solvents.

**General Cleaning.** Rinse all food, beverage, or cosmetic residue from the sink as soon as possible. Some residues, if left to sit in the sink, may require the use of detergent or a mild liquid or gel abrasive cleaner.

### **Hard-to-Remove Food and Beverage**

**Residue.** Use an abrasive cleanser such as Ajax®, Comet®, Bon Ami® or Bar Keeper's Friend® to remove mild stains and for routine cleaning. Use an abrasive pad such as Scotch-Brite® to remove most of the tougher stains.

For the most stubborn stains, fill the sink about one quarter full with a 50/50 solution of bleach and water. After 10 or 15 minutes of soaking, drain solution from the sink as you rinse both sides and bottom.

*NOTE: Do not use steel wool or metal scouring pads.*

**Mineral-Based Stains.** Cleaners designed to remove iron or rust should not harm the sink, nor will solvents such as denatured alcohol, mineral spirits, or acetone.

**Marks or Discoloration.** White automotive rubbing compound may be used to remove stubborn marks or discoloration. Use of these products will not damage the solid surface. Always follow label directions.

---

---

## **DOORS AND WINDOWS**

Windows may be periodically cleaned with a good quality glass cleaner or mild soap solution using a soft cloth.

Use care when removing ice or frost from the windows. Always use a plastic ice scraper, never one made of metal. Use care when removing ice from the mirrors to protect the reflective surfaces.

Door locks and hinges should be lubricated periodically with powdered graphite to ensure trouble-free operation and to protect against freeze-up.

---

---

## **VEHICLE STORAGE – PREPARATION**

Properly preparing your vehicle for storage will lessen the possibility of damage to your vehicle. Prepare the motorhome for vacancy just as you would if you were leaving your house for an extended period.

### **Clean and Prep Coach for Storage**

1. Turn off the propane gas tank.
2. Turn the electronic thermostat switch OFF.
3. **Remove all foods and items that may cause odors from cabinets and refrigerator.**
4. Clean and defrost the refrigerator. Prop the door open slightly to allow any odors to dissipate. Place an open box of baking soda inside the refrigerator to help absorb odors.
5. **Fully charge the batteries. Batteries must have at least 80% charge to survive freezing temperatures and long period of non-use.** We recommend that you connect a battery charger or plug in the shoreline once a

## SECTION 11 – MAINTENANCE AND STORAGE

---

month during long-term storage periods to maintain battery charge and to avoid sulfating. If connecting a charger directly to batteries, turn the House/Coach Battery Disconnect switch off to avoid electrical arcing when attaching and detaching charge clamps.

*NOTE: We do not recommend leaving the shoreline plugged in continuously during storage.*

6. After charging batteries, turn the House/Coach Battery and Chassis Battery Disconnect switches off to disconnect the batteries and avoid parasitic\* drain.  
*\* Parasitic battery drain is the gradual drain by items connected directly to battery power such as clocks, radio memory, and the engine computer.*
7. Have the vehicle chassis completely serviced and lubricated. Be sure radiator antifreeze protection level is sufficient for the lowest anticipated temperatures.
8. Wash and wax the coach.
9. Inspect all seams and seals around doors, windows, vents, and any other joints. Replace or repair any that are damaged. Sealing materials and compounds can be purchased from your dealer. Badly damaged weather seals may need to be replaced by your dealer.
10. Close all windows and roof vents. Protect all appliance vent openings from contamination by animals or insects (e.g. bird nest, wasp nests, etc.)
11. Lubricate all door hinges and locks.
12. Clean the interior of the coach. Dirt and stains are more easily removed when fresh.

If you are storing your vehicle through the winter or in cold climates, extra preparations must be made to protect equipment and systems that can be damaged by freezing temperatures. See “Winterizing Procedure” in *Section 7 - Plumbing*.

---

---

## VEHICLE STORAGE – REMOVAL

1. Completely air out the motorhome.
  2. Have the entire LP gas system checked for leaks.
  3. Check window operation.
  4. Check cabinet and door hinges. Lubricate with penetrating oil, if necessary.
  5. Close all faucets and drain valves that are open.
  6. Add a few gallons of water to the fresh water tank and turn on the water pump to check for leaks, especially at fittings.
  7. Open all faucets in turn to release trapped air and check to be sure faucet washers have not hardened during storage.
  8. Sanitize the water system as outlined under “Disinfecting the Fresh Water System” in *Section 7 - Plumbing*, then flush the waterlines thoroughly with fresh water.
  9. After flushing fresh waterlines, install a new water filter cartridge on the galley sink water filter and/or full-coach water filtration system (if equipped). See appropriate filter installation instructions in *Section 7 - Plumbing*.
- NOTE: Always purge a new filter with clean running water before using. See filter manufacturer’s directions included with the filter cartridge.*
10. Check the toilet for proper operation.
  11. Add water to the holding tank using the toilet flush pedal (or the “Normal Flush” switch if your coach is equipped with an electric flush toilet) and galley sink faucet. Check to be sure dump valves seal tightly.
  12. Check around all appliances for obstructions and ensure that all vent openings are clear.
  13. Start refrigerator and check for proper cooling.
  14. Clean wall and counter surfaces.
  15. Replace batteries, if necessary, and check out electrical system to make sure all lights and electrical components operate.

16. Check tires for proper cold inflation pressure. See “Vehicle Certification Label” in *Section 1 - Introduction*
17. After washing accumulated winter grime from the vehicle, it is important to carefully inspect the seams and sealants for separation or cracks that may have appeared around the window frames, vents, and any other joints. See *Sealants – Inspection and General Information* at the beginning of this section. Re-sealing is quite simple and the material is quickly and easily applied. Appropriate compounds are available from your dealer. See *Sealants – Recommended Application* page in the Supplement Manual provided in your InfoCase.  
Also inspect weather seals around doors, etc., and if necessary, have a dealer replace immediately.

### Ice Maker Start-Up

- Flush antifreeze from the waterlines (if antifreeze fill winterization procedure was performed).
- Close all drain valves.
- Turn Ice Maker Winterization Drain valve to the CLOSED position.
- Turn the water supply ON.
- Ensure the ice bin is in place and the wire shut-off arm is lowered to the ON position.
- Allow the refrigerator to cool down to ice making temperature. Remember, this can take up to 24 hours.

*NOTE: Discard the first two batches of ice cubes. It will take approximately three cycles for the Ice Maker to produce fully formed, clean ice cubes.*

### Washer/Dryer (if equipped)

See “Winterizing Optional Appliances” in *Section 7 – Plumbing* for information on how to remove from storage.

---

---

## CHASSIS SERVICE AND MAINTENANCE

Consult the appropriate sections in the chassis manual for specific information regarding operating safety, service recommendations, and maintenance schedules for the chassis section of your vehicle.

---

---

## CHASSIS FUSES AND RELAYS –Freightliner® Chassis

Chassis and dash component fuses and relays are located in the 12-volt electrical compartment at the left front of the coach.

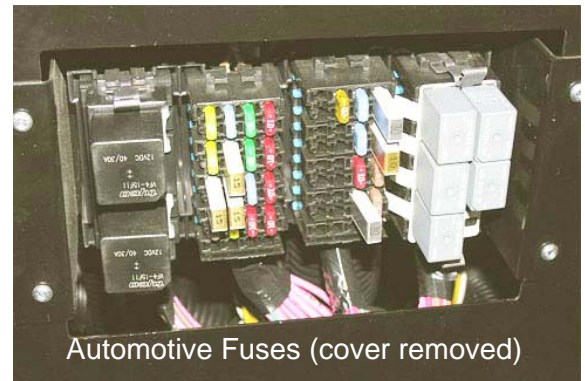
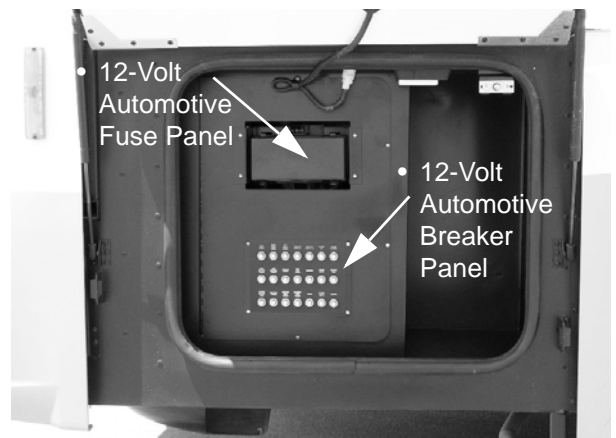

## SECTION 11 – MAINTENANCE AND STORAGE



Fuse Diagram (inside of cover)

See the chassis manufacturer's fuse allocation chart on the inside of the fuse block cover.

### Towing Fuses

The fuses for the chassis supplied towing package are located inside the driver side rear compartment.



Towing Package Fuses  
(Located in driver side rear compartment)  
-Typical View

- Unhook (3) latches to remove cover.
- See chassis manufacturer's information on inside of cover.

### CHASSIS DIAGNOSTIC CONNECTORS

The Chassis Diagnostic Connectors are located near the steering column support plate beneath the dash and in the rear engine compartment, as shown in the following photos.



Diagnostic Plug  
(Located on steering column support beneath left side of dash)  
-Typical View

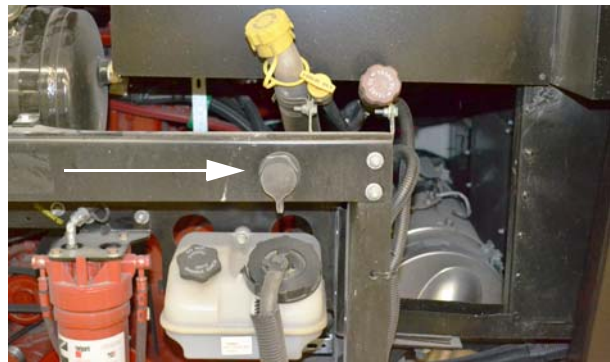

Diagnostic Plug  
(Located on rear engine compartment shroud)  
-Typical View



**SECTION 11 –  
MAINTENANCE AND STORAGE**

**COACH MAINTENANCE CHART**

These recommendations apply for normal recreational use. Heavy duty or full-time use may require more frequent maintenance intervals.

Always use specified sections or manufacturer's guide for further information and instructions.	Before Each Use	Weekly	Monthly	Every 3 Months	Every 6 Months	Every Year	As Necessary
<b>Propane Gas System (if equipped)</b>							
Have propane gas system checked for leaks						◆	◆
Pressure Regulator - inspect and adjust if needed						◆	
Check propane tank condition, mounting, and fittings						◆	
<b>Electrical System</b>							
Check Battery Condition Meter	◆						
Check battery fluid level and connections			◆				
Check 12V fuses and 120V breakers							◆
Check GFCI receptacles			◆				
<b>Generator</b>							
Visually inspect generator and compartment	◆						
See generator manufacturer's maintenance guide							◆
<b>Plumbing System</b>							
Sanitize plumbing system							◆
Winterize plumbing system							◆
Clean water pump strainer filter						◆	◆
<b>Slideout &amp; Leveling System</b>							
Check and adjust							◆
Check hydraulic oil level			◆				◆
Check hydraulic lines (routing, leaks, etc.)						◆	
Inspect slideout room seals (bulb seals), clean as necessary				◆			
Check and inspect electric slideout lock drain line(s)							◆
<b>Exterior</b>							
Clean roof				◆			◆
Clean sidewalls			◆				◆
Clean windows							◆
Flush underside of vehicle				◆			◆

# SECTION 11 – MAINTENANCE AND STORAGE

## COACH MAINTENANCE CHART

These recommendations apply for normal recreational use. Heavy duty or full-time use may require more frequent maintenance intervals.

Always use specified sections or manufacturer's guide for further information and instructions.	Before Each Use	Weekly	Monthly	Every 3 Months	Every 6 Months	Every Year	As Necessary
<b>Safety Equipment</b>							
Check operation of the following items:							
Headlights, Taillights, and Marker Lights	◆		◆				
Turn Signals	◆		◆				
Horn	◆		◆				
Hazard Warning Flashers	◆		◆				
Windshield Wipers and Washers	◆		◆				
Fire Extinguisher - check charge indicator	◆		◆				
Smoke Alarm - test operation *	◆		◆				
Carbon Monoxide Alarm - test operation *	◆		◆				
Propane Gas Leak Detector - test operation (if equipped)	◆		◆				
(*replace battery if needed)							
<b>Appliances</b>							
<b>Refrigerator</b>							
See refrigerator manufacturer's maintenance guide							◆
Inspect and clean exterior vent/drip tray drain tube	◆						◆
<b>Furnace</b>							
See furnace manufacturer's maintenance guide							◆
Inspect and clean exterior vent	◆						◆
<b>Air Conditioner</b>							
See A/C manufacturer's maintenance guide							◆
Inspect for exterior damage				◆			◆
Check/replace filter			◆				
<b>Range Top</b>							
See range manufacturer's maintenance guide							◆
Inspect and clean/replace range hood grease filter							◆

**SECTION 11 –  
MAINTENANCE AND STORAGE**

**COACH MAINTENANCE CHART**

These recommendations apply for normal recreational use. Heavy duty or full-time use may require more frequent maintenance intervals.

Always use specified sections or manufacturer's guide for further information and instructions.	Before Each Use	Weekly	Monthly	Every 3 Months	Every 6 Months	Every Year	As Necessary
<b>Sealants</b>							
Inspect (see "Sealants - Inspection and General Information" at the beginning of this section for proper inspection technique)					◆		◆
Replace (see "Sealant Call-out Sheet" in the supplement manual provided in your InfoCase)							◆
<b>Frame &amp; Chassis</b>							
Follow chassis manufacturer's maintenance guide (refer to chassis manual)							◆
Inspect hitch receiver (if towing)	◆						
<b>Tires</b>							
Check and adjust air pressure	◆						◆
Check tread wear	◆						◆
Check front end alignment and adjust if needed							◆
<b>Miscellaneous</b>							
Lubricate locks, hinges, and latches						◆	◆



## SECTION 12 – MISCELLANEOUS

---

---

---

### LOADING THE VEHICLE

*NOTE: Your motorhome's load capacity is designated by weight, not by volume, so you cannot necessarily use all available space when loading your motorhome.*

- Store or secure all loose items inside the motorhome before traveling. Possible overlooked items such as canned goods or small appliances on the countertop, cooking pans on the range, or free-standing furniture items can become dangerous projectiles during a sudden stop or evasive maneuver.
- Be aware of GVWR, GAWR, and individual load limit on each tire or set of duals.

When loading the vehicle, distribute the cargo load equally so that you do not exceed either the Front or Rear Gross Axle Weight Rating (GAWR) or the Gross Vehicle Weight Rating (GVWR). The Gross Axle Weight Rating (GAWR) means the weight value specified by the chassis manufacturer as the load carrying capacity of a single axle system as measured at the tire-to-ground interfaces. This is the total weight a given axle is capable of carrying. Each axle has its own rating.

Have your vehicle weighed to determine the proper load distribution for your vehicle. Also distribute cargo side-to-side so the weight on each tire or dual set does not exceed one half of the GAWR for either axle.

For example, if the Front GAWR is 6,000 lbs., there should be no more than 3,000 lbs. on each tire. (If the left side weighs 3,100 lbs. and the right side weighs 2,700 lbs., at least 100 lbs. of the load must be shifted from the left side to the right side.) The GVWR is listed on the Vehicle Certification Label. (See sample in *Section 1 - Introduction*).

The GCWR (Gross Combination Weight Rating) means the maximum allowable loaded weight of this motorhome and any towed trailer or towed vehicle.

*NOTE: We recommend that you dump all holding tanks before traveling to avoid carrying unnecessary weight.*

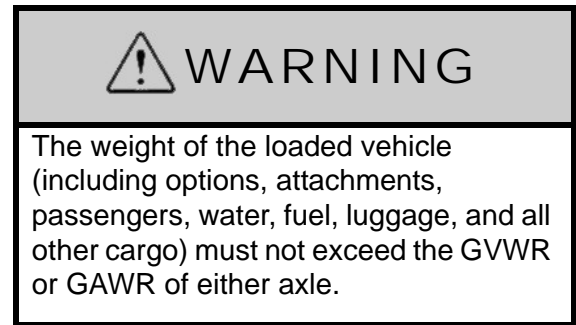

---

---

### WEIGHING YOUR LOADED VEHICLE

To check the weight of your fully loaded coach, locate a commercial weighing scale that is capable of weighing large trucks.

*NOTE: Sales literature may give approximate or standard weights. Your actual coach weight may differ based on added factory and/or dealer options.*

#### **Loading**

Load your vehicle completely as if you were going on a long trip with everything you would carry, including food, clothing, bedding, lawn chairs, etc., a full fuel tank, full propane tank, and a partial tank of fresh water, but empty holding tanks. Remember, tongue weight must be included in the GVWR.

#### **Finding a Scale**

In urban areas, the most common places to find a public access scale are commercial truck stops. In rural areas, most grain storage elevators have scales available. Most scales charge a nominal fee for weighing a vehicle.

#### **Weighing**

There is typically a scale operator to direct you but the basic routine is to take three separate weights - front axle, whole vehicle, and rear axle.

## SECTION 12 – MISCELLANEOUS

You will first drive only your front wheels onto the scale pad, then drive ahead so that the whole vehicle is on the scale, then finally pull off until just the rear wheels are on the pad.

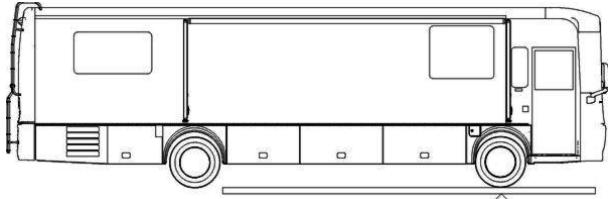

Front GAWR (Front Axle Only)

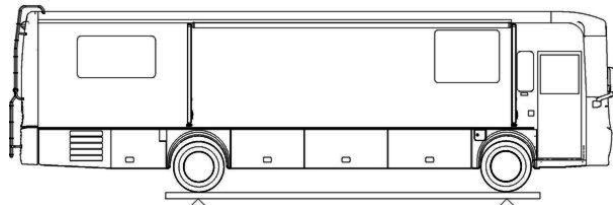

GVWR - Whole Vehicle (All Axles)

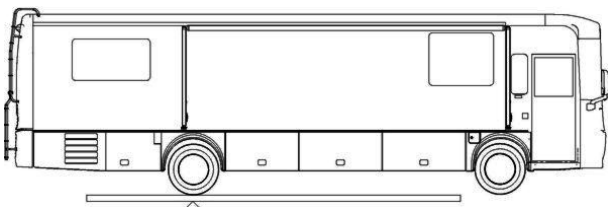

Rear GAWR (Rear Axle Only)

You will receive a weight “ticket” that states your current Front Gross Axle Weight, Rear Gross Axle Weight, and Gross Vehicle Weight. You can compare these weights to the weight ratings listed on your Vehicle Certification Label to use as a guideline for future loading limits and weight distribution.

The gross weight of the vehicle must not exceed the Gross Vehicle Weight Rating (GVWR) specified on the Vehicle Certification Label. The front and rear axle weight also should not exceed the corresponding Axle Weight Rating specified on the Vehicle Certification Label.

### Corner Weighing (Side-to-Side)

The most accurate method of weighing a motorhome is to weigh each “corner” of the coach separately (single L/R front wheels or L/R rear dual sets.) This method will help you determine how to distribute your cargo to avoid overloading, especially on tires.

To determine the weight distribution on each tire or dual set, you will need to find a scale capable weighing side-to-side, or all four “corners” of the vehicle, separately.

A truck scale may be used if the ground is level with the scale surface and the scale has clearance to drive one side of the coach onto the scale as shown.

Drive the coach on the level area next to the scale and straddle the scale so that only one side of the coach will be on the scale pad.

*NOTE: Wind and precipitation can also cause weight inaccuracies.*

Pull only the right front wheel onto the scale pad as shown.

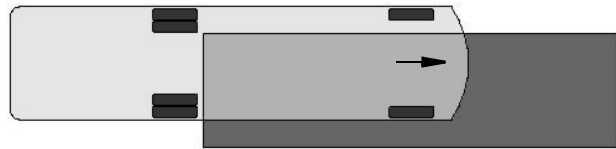

Weighing Right Front Corner

When the front wheel has been weighed, pull the coach straight ahead until only the right rear wheel/dual set is on the scale pad as shown.



Weighing Right Rear Corner

Now, turn the coach around and repeat the process for the other side.

The load on each wheel or dual-wheel set should not exceed one-half of the corresponding GAWR. For example, if the GAWR for the rear

axle is 12,000 lbs., then the load on each rear dual set (left rear duals or right rear duals) should not exceed 6,000 lbs.

Tires must be filled to the recommended air pressure for the highest loaded tire set on that axle. For example, on the rear axle, if the left side weighs more than the right, fill the left tires to the pressure required for that weight, then fill the right tires to the same pressure as the left ones.

If your actual weight is considerably less than GAWR, you may be able to lower your tire pressure. See a tire dealer for a load/pressure chart.

*NOTE: The Hitch Load from a Towed Vehicle or carrier box must also be counted on the Rear GAWR and subtracted from the rear axle cargo capacity.*

Be aware that hitch load can affect handling characteristics. The more weight on the hitch, the lighter the front end will feel at the steering wheel.

---

---

## CAR OR TRAILER TOWING

### **Hitch Capacity\***

**15,000 lbs. max.**

### **Tongue Weight\***

**1,500 lbs. max.**

The factory installed towing hitch on this coach is capable of pulling 15,000 lbs. (max). However, the vertical (tongue) weight may vary according to chassis and model combinations (\*see label on hitch). Towing capacity may be less than hitch rating.

When towing a trailer or vehicle, do not exceed either the GVWR, the rear axle GAWR, or the chassis GCWR by the combined loaded weight of the coach and the towed vehicle. *See preceding items “Loading the Vehicle” and “Weighing Your Loaded Vehicle” for explanation of weight ratings.*

Because of individual vehicle use and loading habits, we recommend weighing the vehicle while fully loaded to avoid exceeding any of the

listed Gross Weight Ratings. See “Vehicle Certification Label” in the Introduction section for information on gross weight ratings.

Towing will affect vehicle handling, durability, and fuel economy. Exceeding any of the listed Gross Weight Ratings will result in unacceptable overall vehicle performance. Maximum safety and satisfaction when towing depends on proper use of correct equipment.

When towing a vehicle behind your motorhome, the tow bar should be level or pointing slightly upward towards the tow vehicle.

When coupling the vehicle tow bar to the Factory Receiver Hitch using a “drop receiver” or a conventional “ball mount” (commonly referred to as a “stinger” or a “draw bar”), do not exceed a 4” drop, nor one that the centerline of the hitch pin to the centerline of the ball exceeds 8”. See the following Hitch Assembly illustration.

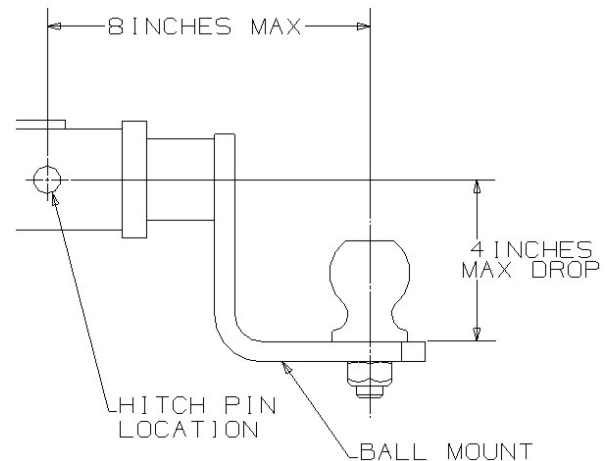

**Hitch Assembly**

If a towing “brake system” is required, we recommend that a “modulated” towed vehicle braking device be installed. This means that when the motorhome brakes are applied, whether hard or soft, a mirror effect occurs in the braking of the towed vehicle. In other words, the more force applied to the motorhome brakes, the more force will be applied to the rear vehicle’s braking system.

## SECTION 12 – MISCELLANEOUS

We do not recommend the usage of a “surge-style” braking device. The usage of a surge brake (especially when coupled with a hitch ball located outside our recommended limits) places excessive stress on the hitch. This abuse of the ball mount and the hitch may cause premature hitch assembly failure.

Finally, do not forget to consider the actual tongue weight. This should not exceed the stated hitch vertical load for your vehicle. This weight is typically defined as the tongue weight of a towed vehicle hitch, boat trailer tongue weight, or a receiver-mounted carrier rack.

Check state regulations on trailer weight and trailer brake requirements to be sure you select the right equipment before towing.

Before descending a steep or long grade when towing a trailer, reduce speed and shift into a lower gear to control vehicle speed. Avoid prolonged or frequent application of brakes which could cause overheating and brake failure.



### WARNING

For safe towing and vehicle handling, maintain proper trailer weight distribution. The total weight of the motorhome and the vehicle towed must not exceed the Gross Combined Vehicle Weight rating. See the “Body and Chassis Specification” chart in the Introduction section.

### NOTICE

Exceeding any of the recommended gross vehicle weight ratings may result in vehicle damage. Do not install a frame equalizing-type hitch on your vehicle.

## TRAILER WIRING CONNECTOR

Your coach is pre-wired for trailer or car towing lights with a 7-pin socket.

The following diagram shows proper connection of trailer or tow vehicle wiring to the coach light system. The “pigtail” assembly with the (car/trailer end) connector plug should be wired by a qualified technician.

The trailer brake controller connector is located to the left of the steering column.

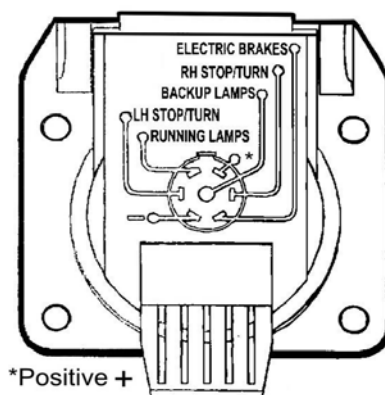

## TOWING GUIDELINES

### Gross Vehicle Weight Rating (GVWR)

This is the maximum allowable weight of the fully loaded vehicle. Included are fuel, water, LP, passengers, cargo, tools, and optional equipment installed by the motorhome manufacturer, dealer, or owner. This value is found on the VIN label, typically placed near the driver position.

### Gross Axle Weight Rating (GAWR)

This is the total weight a given axle is capable of carrying, measured at the ground. Each axle has its own rating. These values are also found on the Vehicle Certification Label: front and rear.

### Gross Combination Weight Rating (GCWR)

This is the maximum allowable weight of the motorhome and loaded trailer, including the items noted in GVWR above. For purposes of



this definition, the “trailer” can be a trailer, a vehicle towed on a dolly, or a vehicle towed by means of a tow bar. GCWR is typically specified based on durability and performance of the tow vehicle drive train: engine and cooling systems, transmission, drive line, drive axle, and others. The tow vehicle brakes may be rated for operation at GVWR, not GCWR.

*NOTE: State or provincial laws/regulations may require the “trailer” to be equipped with brakes that are activated when the motorhome brakes are applied. The user is responsible to know and understand the laws of the state or province being traveled. The Department of Transportation in a given state or province should be able to provide specific information.*

## Hitch Ratings

SAE Standard J684 defines:

- Class 1 trailers as “GVWR not to exceed 2,000 lbs”.
- Class 2 trailers as “GVWR over 2,000 lbs. and not to exceed 3,500 lbs. GVWR”.
- Class 3 trailers as “GVWR over 3,500 lbs. and not to exceed 5,000 lbs. GVWR”.
- Class 4 trailers as “GVWR over 5,000 lbs. and not to exceed 10,000 lbs. GVWR”.

Although no SAE standard above Class 4 exist, Class 5 trailers are generally referred to in the industry as GVWR over 10,000 lbs. Winnebago Industries® provides a Class 5 hitch on some tag axle vehicles with 15,000 lbs. maximum trailer weight and 1,500 lbs. maximum vertical tongue weight. Since no SAE standard exists today, the ratings of Class 5 and higher hitch ratings may vary from manufacture to manufacture. The Winnebago® Class 5 hitch is 15,000/1,500.

Hitches are to be permanently marked with “Maximum trailer GVWR to be drawn” and “Maximum vertical tongue weight to be imposed.” The SAE standard does not specify a vertical load rating.

Traditionally, hitches are labeled 3,500/350 as Class 2, 5,000/500 as Class 3, and 10,000/1,000 as Class 4. The vertical tongue load value of 10 percent of drawn rating comes from the collective experience that 10 percent is the minimum value that provides stable towing of a trailer.

Ford’s towing guide suggests 10 to 15 percent for trailers over 2,000 lbs. Within GCWR, a Class 3 hitch allows “dingy” towing a large car or mid-size SUV; a Class 4 hitch allows “dingy” towing a large SUV or pickup. (Hitch ratings are independent of towing vehicle ratings.)

*NOTE: Some Winnebago Industries models equipped with a Class 3 hitch may have a label limiting vertical tongue load to 350 lbs. Some Winnebago Industries models equipped with a Class IV hitch have a label limiting vertical tongue load to 500 lbs. On a 228" wheelbase, a 500-lb. load on a hitch 11' from the rear axle will apply about 800 lbs. at the axle.*

The user must verify that the hitch equipment being used is adequate for the application.

---

---

## FIREPLACE

### -If Equipped



-Typical View

- The fireplace can be operated by either the remote control or the control panel. The control panel is located on the upper right hand corner of the fireplace.

## SECTION 12 – MISCELLANEOUS

### Remote Operation

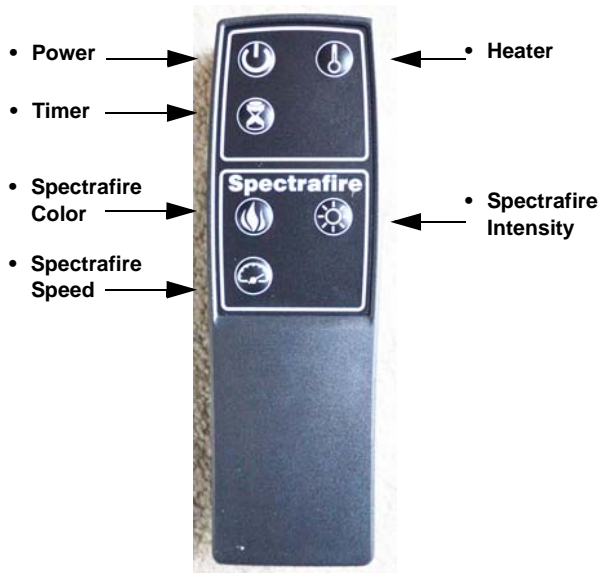

Fireplace Remote Control  
(Located inside InfoCase)

- **POWER:** The POWER button supplies power to all the functions of the fireplace.
- **HEATER:** Turns the heater function ON and OFF. The thermostat is adjustable by 2°F increments. The button on the remote only turns the heater on/off to the thermostat setting selected with the control panel.
- **SPECTRAFIRE COLOR:** Press to cycle through the (5) flame effects: Spectrafire, Sapphire, Amethyst, Campfire, and Midnight Fire. You can also select Auto Cycle to fade in and fade out a new color flame effect periodically.
- **SPECTRAFIRE INTENSITY:** This feature is only adjustable from the remote control. Each flame color has (5) intensity options available.
- **SPECTRAFIRE SPEED:** This feature is only adjustable from the remote control. Each flame color has speed options available. Setting 1 is slowest ranging up to setting 5 which is the fastest.
- **TIMER:** Press the TIMER button to cycle through the (10) timer settings (30 minutes, 1 Hour to 9 Hours) and the OFF setting.

### Further Information

Refer to the Fireplace user guide provided in your InfoCase for complete operating and maintenance instructions, as well as safety precautions.

### FIREPLACE -If Equipped



-Typical View

*NOTE: The fireplace can be operated by either the remote control or the control panel.*

### Remote Operation



Fireplace Remote Control  
(Located inside InfoCase)

- **POWER:** The POWER button supplies power to all the functions of the fireplace. The POWER button will put the insert in standby mode. This will turn off all functions at once but will hold the settings in the memory. By pressing the POWER button again the unit will turn on at the same settings.

- **FLAME:** Each time the flame button is pressed, the intensity of the flame decreases. There are (6) brightness levels you can cycle through and the OFF setting.
- **HEATER:** Turns the heater function ON and OFF. The thermostat is adjustable by 2°F or 1°C increments by pressing the up or down arrows.
- **SIDELIGHTS:** Press the sidelights button to change the sidelight between (4) settings: amber, blue, blue/amber, auto-cycling, and off.
- **UPLIGHTS:** Press the uplights button to change the uplight between (4) settings: white, blue, white/blue, auto-cycling, and off.
- **TIMER:** Press the TIMER button to cycle through the (10) timer settings (30 minutes, 1 Hour to 9 Hours) and the OFF setting.

### Control Panel



Fireplace Control Panel  
(Located on right side of fireplace)

*NOTE: Holding the POWER button on the control panel for ten seconds will disable the heater function.*

### Further Information

Refer to the Fireplace user guide provided in your InfoCase for complete operating and maintenance instructions, as well as safety precautions.

## FIREPLACE -If Equipped



-Typical View

*NOTE: The fireplace can be operated by either the remote control or the control panel.*

### Remote Operation

- Power
- Flame
- Heater

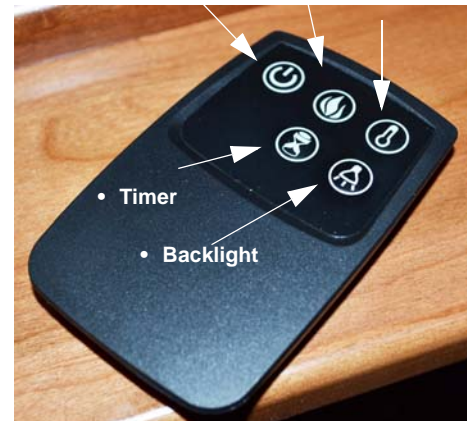

Fireplace Remote Control  
(Located inside InfoCase)

- **POWER:** The POWER button supplies power to all the functions of the fireplace. The POWER button will put the insert in standby mode. This will turn off all functions at once but will hold the settings in the memory. By pressing the POWER button again the unit will turn on at the same settings.
- **FLAME:** Each time the flame button is pressed, the intensity of the flame decreases. There are (6) brightness levels you can cycle through and the OFF setting.

## SECTION 12 – MISCELLANEOUS

- **HEATER:** Turns the heater function ON and OFF.
- **TIMER:** Press the TIMER button to cycle through the (10) timer settings (30 minutes, 1 Hour to 9 Hours) and the OFF setting.
- **BACKLIGHT:** Pressing this button will change the backlight between the (5) settings: blue, yellow, blue/yellow, auto, and OFF.

### Control Panel



- Power
- Flame
- Heater
- Timer
- Backlight

*NOTE: Holding the POWER button on the control panel for ten seconds will disable the heater function.*

### Further Information

Refer to the Fireplace user guide provided in your InfoCase for complete operating and maintenance instructions, as well as safety precautions.

---

---

## COUNTERTOP EXTENSION

### –If Equipped

#### (Typical view – your coach may differ)

Your coach may be equipped with a countertop extension that provides additional galley prep space.

- **To extend galley countertop extension,** pull release lever (located underneath countertop extension lip) outward while pulling countertop extension out.



Countertop Extension Release Lever  
(Located underneath countertop extension lip)  
-Typical View



-Typical View

- **To retract galley countertop extension,** pull release lever outward while pushing countertop extension back into stored position.

*NOTE: Ensure the countertop extension is in the stored position before retracting the slideout room to prevent possible property damage.*

STEP (ENTRY) - ELECTRIC

 <b>WARNING</b>
<p>Do not use step unless fully extended. Do NOT stand on step when vehicle ignition switch is turned to either the “On” or “Start” position. The step will automatically retract, which may cause personal injury.</p>

The power switch for the electric entry step is located to the left of the main entry door as you enter the coach.



Entry Step Switch  
(Located near entrance door)  
-Typical View

- These switches illuminate when the House/ Coach Battery Disconnect switch is ON.

The step has several automatic extend/retract functions that are controlled by the position of a sensor mounted on the inner edge (hinge side) of the screen door.

**Automatic Mode - Entry Step Switch ON**  
**(Step Operates with Door)**

With the Step switch in the ON position, the step is in Automatic Mode. This means it will extend and retract automatically whenever the screen door is opened or closed.



Red Activation Lever

- The red Activation Lever located on the Step switch must be depressed in order to put the step switch in the ON position.

**Stationary Extended Mode - Step Switch OFF**  
**(Step Remains Extended)**

With the Step switch in the OFF position, the step will extend when the screen door is opened and will stay extended whether the door is opened or closed.

*NOTE: The Step switch is “locked” in the OFF position.*

This position is normally used to keep the step extended when parked at a campsite or whenever people will be going in and out the vehicle frequently.

**Automatic Retraction Feature**

The step is equipped with an automatic retraction feature that stores the step automatically if the main entry door is closed and the Ignition Switch key is turned to the On or Run positions.

The step WILL RETRACT even if the Step switch is OFF.

This feature is intended to prevent injury or damage by an extended step while the vehicle is moving.

**Further Information**

For additional information on the step, see the manufacturer’s user guide provided in your InfoCase.

## SECTION 12 – MISCELLANEOUS

### STEPWELL COVER

The stepwell cover can be extended to cover the stepwell area and increase usable floor space in the front of the coach while the entrance door is not in use.

- Press and Hold “EXT” to Extend and “RET” to Retract (located on passenger side cabinet or driver side trim panel). Release when the stepwell cover has extended or retracted fully.



Step Cover Switch  
(Located on passenger side cabinet)  
-Typical View

*The switch will illuminate blue when the switch is on. White illumination indicates the switch is off.*



Step Cover Switch  
(Located on driver side trim panel)  
-Typical View

*The switch will illuminate blue when the switch is on. White illumination indicates the switch is off.*

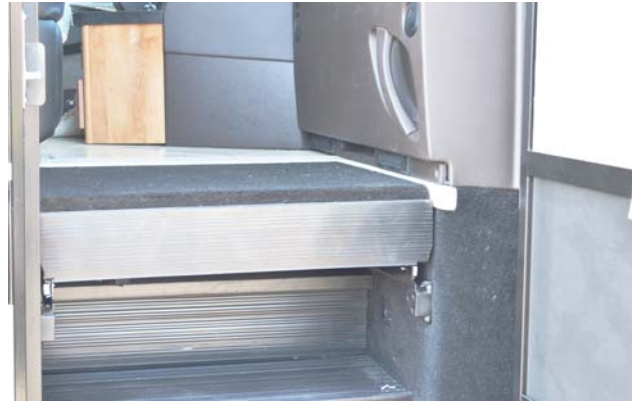

Stepwell Cover shown in extended position  
-Typical View



**CAUTION**

Stay clear of the entrance step area when the step cover is being extended or retracted. Loose clothing may catch on components of the mechanism when entering or exiting the coach. Failure to observe can cause injury.

### Emergency Retract Feature

The stepwell cover is equipped with an Emergency Retract feature in event of an emergency exit situation and/or the stepwell cover fails to retract while in the extended position.

Do not use the Emergency Retract feature unless necessary for an emergency.

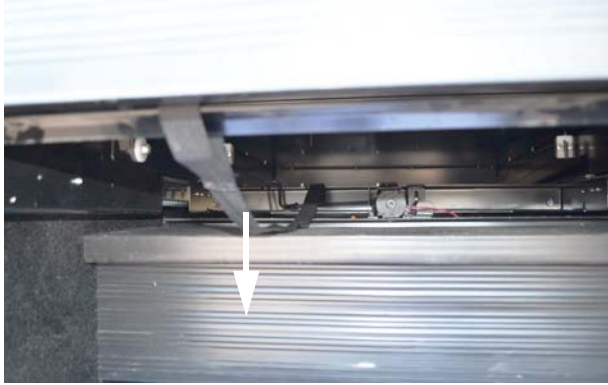

**Emergency Retract Strap**  
(Located underneath stepwell cover)  
Typical View

- To retract the stepwell cover for an emergency exit, pull the Emergency Retract Strap (located underneath the stepwell cover) DOWN. Then push the step IN to store.

---

---

## WINDOWS

### **Crank-Out Windows**

#### **–If Equipped**

- To open, pull out the lever on the window handle and begin cranking the window out “counter-clockwise” to desired position.



-Typical View

- To close, crank the window in snugly (by turning the window handle “clockwise”), then back off 1/4 turn to help avoid glass warping, which can result in wind noise.
- Push the lever back in on the window handle.

If the window will not open after three or more full turns of the knob, the glass may be stuck to the sealing gasket. Go to the outside of the coach

and gently free the glass with your fingers. A periodic light dusting of talcum powder on the gasket should prevent this from recurring.

### **Horizontal Slider Windows**

#### **–If Equipped**

Swing the latch handle straight out or up (depending on the style of window). Grasp the sliding window edge frame and slide the window to the side. Ensure the latch is open before trying to slide the window closed.

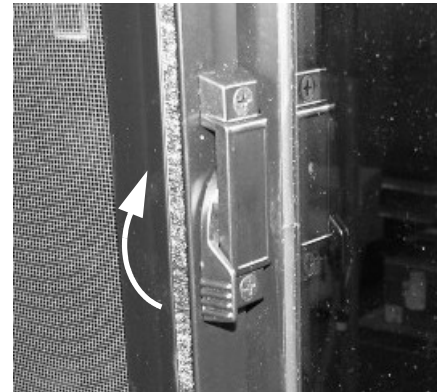

-Typical View

### **Vertical Slider Windows**

#### **–If Equipped**

Vertical windows have spring-loaded catches on both sides of the window that pop out to hold the window in its fully raised position. Press both catches inward while opening and closing the window.

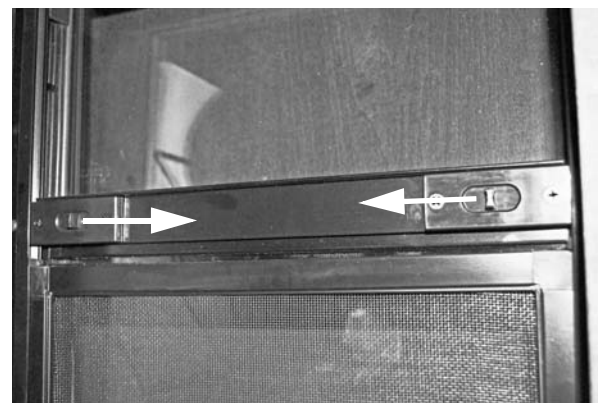

-Typical View

## SECTION 12 – MISCELLANEOUS

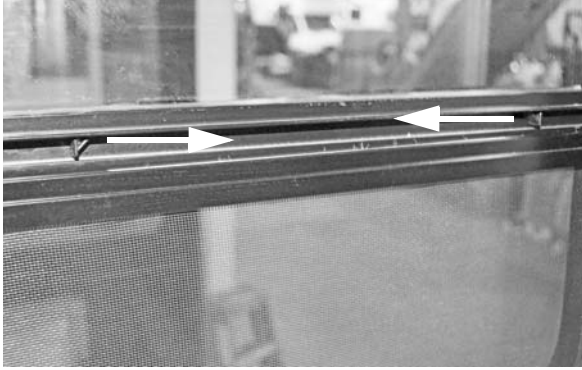

-Typical View

---

---

### POWER ROOF VENTILATOR

#### -If Equipped

The vent is controlled by a switch on the wall, switch on touch tablet (if equipped), or keypad controls on the vent.

*NOTE: In event of power failure, the ventilator dome may be opened or closed manually using the Dome Crank knob.*

#### To Operate Ceiling Ventilator with keypad controls on vent

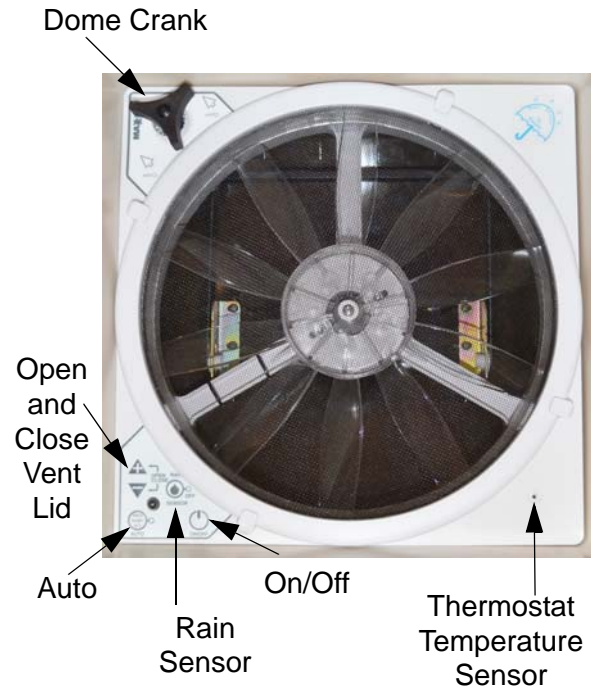

#### Power Roof Ventilator

- **On/Off** - turns the fan on or off.
- **Dome Crank** - manually opens and closes vent lid.
- **Rain Sensor** - turns the rain sensor off (the light will illuminate red when deactivated).
- **Open/Close Arrows** - In Auto Mode, use the (+) and (-) buttons to adjust the thermostat. In Manual Mode, use the (+) and (-) buttons to adjust the fan speed.
- **Auto** - The thermostat will turn the fan on and off depending on the thermostat setting. Press once for less than three (3) seconds. You will hear three (3) quick beeps to confirm Auto Mode (the green light will illuminate). To exit Auto Mode, press the On/Off button.



**To Operate Ceiling Ventilator with wall switch**

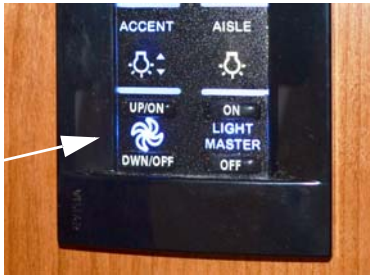

Power Roof Ventilator Switch

- Press the UP/ON switch to turn on and open the vent lid.
- Press the DWN/OFF switch to turn off and close the vent lid.
- Open a window or door to provide airflow. Direction of airflow is determined by which window or door is opened.

*NOTE: For best results, close all other roof vents, windows, and doors, then open one (1) window the farthest distance from the roof ventilator. The fan speed selector allows you to control the amount of circulation you need at any time.*

**To Operate Ceiling Ventilator with Touch Tablet (if equipped)**



Touch Tablet Main Menu

- Tap on “Bath” or “Lounge” (selection displays in white).



Power Roof Ventilator Switch  
(Located on touch tablet “Bath” screen)  
-If Equipped

- Tap on the Mid Bath or Rear Bath Vent Fan Switch to turn vent ON/OFF.

When multi-speed fans are on, tap the ON button to toggle between speeds.



Power Roof Ventilator Switch  
(Located on touch tablet “Lounge” screen)  
-If Equipped

- Tap on “LIGHTS”
- Tap on Vent Fan Switch to turn galley vent ON/OFF.

When multi-speed fans are on, tap the ON button to toggle between speeds.

**Rain Sensor**

The ventilator features a Rain Sensor; when it detects moisture it will turn off the fan and close the lid. After the rain sensor has dried, turn the fan on.

*NOTE: If the lid is opened Manually, the Rain Sensor will not close the vent lid.*

## SECTION 12 – MISCELLANEOUS

---

### Further Information

See the power ventilator manufacturer's operating instructions supplied in your InfoCase for further instructions, care, and cleaning information.

---

---

### SKYLIGHT SHADE

The Skylight features a sliding shade for privacy and light control. The skylight shade switch is located on the dash.



Skylight Shade (Closed Position)  
(Located on dash)



Skylight Shade Control Switch  
(Located on dash)

- Push switch up to open shade.
- Push switch down to close shade.

### Further Information

See the skylight shade manufacturer's operating instructions supplied in your InfoCase for further instructions, care, and cleaning information.

---

---

### STORAGE COMPARTMENT DOORS

The high-density gaskets used on the exterior storage compartments are designed to provide a more positive seal against dust and weather. Sometimes this seal firmness can inhibit complete latching of the compartment doors if they are simply “dropped shut” or closing force is applied only to the center of the door.

To ensure that exterior storage compartment doors have latched properly, press firmly on the bottom edges (side edges - if equipped) of the doors with the palms of your hands. If the door is ajar you will hear and feel a loud “click” when the latches engage properly.

---

---

### COMPARTMENT LIGHTS SWITCH

The Compartment Light switch powers the lights inside of the compartments. This switch is located near the entrance door and inside a driver side compartment.

*NOTE: The Compartment Lights switch provides power to the compartment lights. You must manually turn each individual compartment light on or off inside of the compartments.*

We recommend turning this switch OFF when the coach is not in use to avoid battery drain if a compartment light is left on accidentally.



Compartment Lights Switch  
(Located near entrance door and/or inside  
a driver side compartment)  
-Typical View

*The switch will illuminate blue when the  
switch is on. White illumination indicates  
the switch is off.*

---



---

## AWNING – POWER

Your coach is equipped with entry door and patio power awnings to provide protection against outdoor elements, such as sun, light rain, and wind. The Power Awnings feature built in LED Lights.

The Awning Control switches and LED Light switches are located on the switch panel just inside the entrance door. The Door Awning and LED light switches are also located on the touch tablet (if equipped).



Power Awning Control Switches  
(Located near the entrance door)  
-Typical View

## Power Awning Controls

All function buttons are press and release, it is not necessary to hold down the buttons. The auto-functions continue until the awning is extended or retracted to the desired position.

- **Power On** - The On position activates the Patio Awning switches and the Auto-Retract system.
- **Power Off** - The Off position shuts down the system. The awning cannot be extended or retracted in this mode. The Auto-Retract system is also disabled.
- **Stop** - Press this button (during extend or retract functions) to stop the awning.

## Awning Position Controls

- **Close** - The awning fully closes.
- **Slide-Out** - The awning extends to provide cover for your slide-out room.
- **Window** - The awning extends to provide window shade to cool the inside of your coach.
- **Patio** - The awning fully extends to provide a full patio awning.

## Wind Sensor Auto-Retract Feature

If the Wind Sensor is activated, the system will automatically retract the Patio Awning during windy conditions. Sensitivity threshold is set on the control panel.

## Wind Speed (Awning Sensitivity) Switch

Low requires the least amount of motion before automatically closing the awning. High requires more motion before the system automatically closes the awning. You may want to experiment first to find the setting that best suits your needs.

*NOTE: The Windsensor Auto-Retract system is on when the Awning Power switch is On and is off when the Awning Power switch is set to Off. If the power is shut off while the awning is extended, the awning is not protected by the Auto-Retract system.*

## SECTION 12 – MISCELLANEOUS

The Direct Response system detects awning motion caused by windy conditions. The awning operates in two stages:

- The first stage applies when the awning is extended past the slide-out position. When persistent motion exceeds the factory preset threshold for two seconds or longer, the awning will retract to the slide-out position. This stage is controlled on the keypad settings.
- The second stage applies when the awning is in the slide-out cover position. The awning will fully retract when the motion of the awning exceeds the extreme weather threshold. This stage is not controlled by the keypad settings.

Gust detection is incorporated into the Direct Response software. When the motion value is suddenly and sharply increased above a safe maximum value, the two second persistence measure is overridden and the awning will close immediately.

**CAUTION**

The Auto-Retract feature provides protection against adverse elements, but no Auto-Retract system is a guarantee against severe or destructive weather. The effects of wind and rain on an awning are unpredictable and may cause severe damage to the awning and/or vehicle. If a situation arises where wind or extended periods of rain are expected, retract the awning.

### Entry Door Awning and Awning Light Switch Operation

The entry door awning and awning lights can be operated by either the switch panel located near the entrance door or the touch tablet (if equipped).

Your coach is equipped with one of the switches shown below.

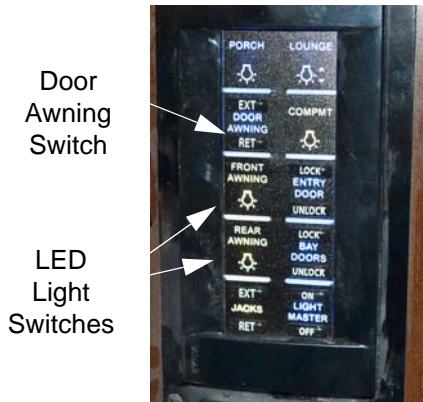

Power Door Awning and LED Light Control Switches  
(Located near the entrance door)  
-Typical View

*The switch will illuminate blue when the switch is on. White illumination indicates the switch is off.*

#### Power Door Awning:

- **EXTEND** - Press and Hold the EXT button on the Door Awning switch until the awning is in the desired position, then release the switch.
- **RETRACT** - Press and Hold the RET button on the Door Awning switch until the awning is in the desired position, then release the switch.

#### Front and Rear Awning Light Switches:

- Press to turn lights ON/OFF.



Touch Tablet Main Menu

- Tap on "Exterior" (selection displays in white).



### Power Door Awning and LED Light Control Switches

(Located on touch tablet “Exterior” screen)

#### Power Door Awning:

- Press and Hold to Extend or Retract awning.
- Release to Stop.

#### Front and Rear Awning Light Switches

- Tap to turn lights ON/OFF.

-If Equipped

### Manual Override (Entry Door Awning)

In the rare event that the Entry Door Awning will not retract, a Manual Override procedure may be performed.

*NOTE: The Manual Override procedure cannot be used to extend the awning.*

- Remove three screws from the front inward end of the Entry Door Awning End Cap.
- Remove end cap and set aside.

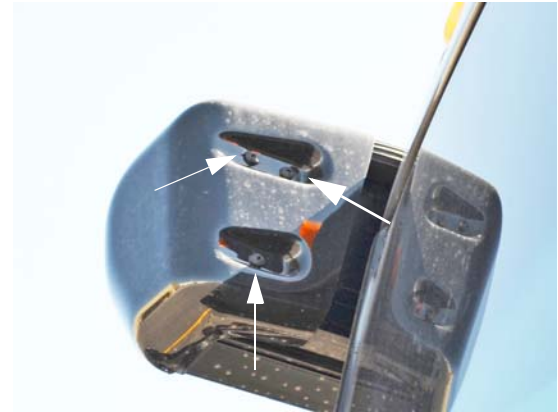

### Entry Door Awning End Cap (Located on front inward end of Entry Door Awning)

*Remove three screws and end cap to access idler end of the awning for Manual Override.*

- Refer to the “Manual Override” section of the awning manufacturer’s user guide provided in your InfoCase for complete instructions to safely retract the awning.

*NOTE: After the Entry Door Awning has been manually retracted, ensure that the end cap and screws have been reinstalled.*

### Ignition Lockout System

The Ignition Lockout System will disable the extend function while the vehicle ignition key is in the On position. With this feature, the awning will only extend when the vehicle ignition key is in the Off position. The awning can retract anytime regardless of the ignition key position.

### Further Information

Refer to the awning manufacturer’s user guide provided in your InfoCase for complete operating instructions and safety precautions.

---

---

## AIR HOSE CONNECTOR

### -If Equipped

For convenience, your coach may be equipped with a Quick-Connect Air Coupler, which you can connect an air hose for inflating tires or sports and camping equipment, if needed.

## SECTION 12 – MISCELLANEOUS

---

*NOTE: Air hose and inflation or blowing attachments are not supplied and must be obtained separately.*

The Quick-Connect Air Coupler is located behind the hood panel at the front end of the vehicle. Instructions for connection and disconnection are shown on the label at the coupler.

 **WARNING**

Compressed air can be hazardous. Proper eye protection must be worn. Close valve before connecting or disconnecting hose. Direct air discharge away from self and others.



Quick-Connect Air Coupler  
(Located behind front hood panel)  
-Typical installation shown

The air is supplied by the chassis air brake/suspension system air accumulator tank.

When the air pressure is less than what you need to inflate an item, you must start the coach engine to run the system air compressor to refill the tank.

---

---

## EFFECTS OF PROLONGED OCCUPANCY

Your motorhome was designed primarily for recreational use and short-term occupancy. If you expect to occupy your coach for an extended period, be prepared to deal with condensation and humid conditions that may be encountered.

### Humidity and Condensation

Moisture condensing on the inside of windows is a visible indication that there is too much humidity inside the coach. Excessive moisture can cause water stains or mildew, which can damage interior items such as upholstery and cabinets.

When you recognize the signs of excessive moisture and condensation in your coach, you should take immediate action to minimize their effects.

You can help reduce excessive moisture inside the motorhome by taking the following steps:

#### Ventilate with outside air

Partially open one or more windows and a roof vent to circulate outside air through the coach. In cold weather, this ventilation may increase use of the furnace, but it will greatly reduce the condensation inside the coach.

#### Minimize moisture released inside the coach

Run the range hood fan while cooking and open a bath vent while bathing or showering to carry water vapor out of the coach. Avoid making steam from boiling water excessively or letting hot water run. Avoid bringing extra moisture into the coach by way of soaked clothing or snow on shoes. Do not hang-dry wet overcoats or clothing inside the coach.

# INDEX

---

About this Manual .....	1-1
Accent LED Light Strips (Front) .....	3-6
Air Conditioner Filters .....	4-15
Air Conditioner/Heater – Automotive (Dash) .....	3-22
Air Horns .....	3-23
Air Hose Connector .....	12-17
Audio/Video System Basic Operation .....	8-3
Awning – Power .....	12-15
Bathroom .....	11-10
Battery Access .....	6-10
Battery Boost Switch .....	3-21
Battery Care .....	6-11
Battery Information .....	6-10
Bed – Power Lift .....	9-9
Before Driving .....	1-2
Bose® Sound Bar System .....	8-4
Brake/Accelerator Pedals – Adjustable .....	3-18
Cabinetry – Cleaning .....	11-7
Car or Trailer Towing .....	12-3
Carbon Monoxide Alarm .....	2-4
Carbon Monoxide Warning .....	2-4
CB Radio Power Wiring .....	3-14
Central Vacuum Cleaner .....	4-18
Ceramic Tile – Polished .....	11-10
Chassis Battery Disconnect Switch .....	3-28
Chassis Diagnostic Connectors .....	11-14
Chassis Fuses and Relays .....	11-13
Chassis Service and Maintenance .....	11-13
Checking Hydraulic Oil Level (HWH®) .....	10-15
Circuit Breakers – House 120-Volt AC .....	6-5
Circuit Breakers – House 12-Volt .....	6-13
Circuit Breakers and Fuses – Chassis/Dash Automotive 12-Volt .....	3-29
Coach Maintenance Chart .....	11-15
Cold Water Filter .....	7-5
Cold Water Filter .....	7-6
Collision Avoidance System .....	3-6
Compartment Lights Switch .....	12-14
Countertop Extension .....	12-8
Decorative Vinyl Wall Paneling – Cleaning .....	11-7
Defrost Fans .....	3-22
Diesel Exhaust Fluid Fill .....	3-27
Digital Sleep Air Bed .....	9-9

---

# Index

---

Dishwasher .....	4-17
Disinfecting Your Fresh Water System .....	7-8
Doors and Windows .....	11-11
Drainage System (P-Traps) .....	7-11
Driving Safety .....	2-1
Effects of Prolonged Occupancy .....	12-18
Electrical .....	2-6
Electrical Cautions .....	6-1
Electrical Generator .....	6-7
Electrical Outlets – House 120-Volt AC .....	6-6
Electrical System – House 120-Volt AC .....	6-1
Electrical System – House 12-Volt DC .....	6-9
Emergency Exits .....	2-7
Engine Access Covers – Rear Bath .....	3-25
Engine Block Heater – Diesel Engine .....	3-24
Engine Brake System .....	3-14
Engine Cooling System .....	3-28
Engine Overheat .....	2-10
Engine Service Access Grille – Rear .....	3-24
Extendable Sectional Sofa/Sleeper .....	9-7
Exterior Automotive Paint Finish .....	11-2
Exterior Entertainment Center (Adjustable) .....	8-12
Exterior Graphic Care .....	11-4
Exterior Shower/Wash Station .....	7-10
Filling the Fuel Tank – Diesel Engine .....	3-23
Fire Extinguisher .....	2-6
Fireplace .....	12-5
Fireplace .....	12-6
Fireplace .....	12-7
Formaldehyde Information .....	2-8
Fresh Water System .....	7-1
Front Axle Tire Alignment .....	1-2
Front Drop-Down Solar/Night Shade (12-Volt) .....	3-8
Front End Masks and Paint Damage .....	11-4
Front Service Access .....	3-30
Front TV Ignition Switch Interlock .....	8-3
Fuel and Propane Gas .....	2-2
Fuel Selection – Diesel Engine .....	3-23
Fuel/Water Separator – Diesel .....	3-27
Full-Coach Water Filtration System .....	7-7
General Slideout Care .....	10-10
General Warnings .....	2-1
Ground Fault Circuit Interrupter .....	6-6
Hazard Warning Flashers .....	3-16
HDMI Video Selection System .....	8-1

---



---

HDMI Video Selection System .....	8-2
Headlight Switch .....	3-16
Headlights and Exterior Lights .....	11-5
House/Coach Battery Disconnect Switch .....	6-10
Hub Cover .....	3-31
Hydronic Heating System .....	4-12
Ice Maker .....	4-2
Ice Maker Water Filter .....	7-7
Infotainment Center (House Mode) .....	8-6
Infotainment Center/GPS .....	3-11
Infotainment Center/GPS .....	3-9
Interior Soft Goods .....	11-6
Inverter/Charger Unit – 2800W (Pure Sine Wave) .....	6-4
Jump Starting .....	2-10
KeyOne™ Lock System .....	3-4
Leveling System (Air and Hydraulic) .....	10-13
Leveling System (Hydraulic) .....	10-10
Lights .....	3-32
Loading .....	2-6
Loading the Vehicle .....	12-1
Lounge Chair – Swivel .....	9-1
Maintenance .....	2-7
Microwave/Convection Oven With Range Hood .....	4-5
Mirrors – Power Electric .....	3-7
Mold, Moisture, and Your Motorhome .....	2-8
Monitor Panel .....	4-5
Monitor Panel (Touch Tablet) .....	4-6
Occupant and Cargo Carrying Capacity Label .....	1-3
Owner and Vehicle Information .....	1-6
Parking Brake .....	3-14
Plastic Parts – Cleaning .....	11-5
Power Control System (PCS) .....	4-8
Power Cord – External .....	6-1
Power Cord Reel .....	6-3
Power Door Locks .....	3-4
Power Roof Ventilator .....	12-12
Power Shades – Night (12-Volt) .....	9-10
Power Sofas and Beds .....	2-7
Pre-Delivery Inspection .....	1-2
Propane Accessory Connection .....	5-2
Propane Gas Leak Detector .....	2-3
Propane Gas Leaks .....	2-3
Propane Gas Pressure Regulator – Removable LP Tank .....	5-5
Propane Gas Supply – Removable .....	5-1
Propane Gas Warnings and Precautions .....	5-4

---

# Index

---

Propane Vaporization in Cold Weather .....	5-6
Range and Refrigerator .....	11-10
Range Top (Electric) .....	4-4
Refrigerator – Residential .....	4-1
Refrigerator Service Access Compartment – Residential .....	4-3
Refrigerator/Freezer – Portable .....	4-4
Reporting Safety Defects .....	1-2
Roadside Emergency .....	2-9
Roller Shades (Manual) – Solar/Blackout .....	9-11
Roof .....	11-1
Roof .....	2-9
Safe Use of the Propane Gas System .....	5-3
Safety Messages Used in this Manual .....	1-1
Satellite Dish and Cable TV Connections (Input) .....	8-10
Sealants – Inspection and General Information .....	11-1
Seat Belts .....	3-3
Seats – Driver/Co-Pilot .....	3-1
Service and Assistance .....	1-2
Shower Hose Vacuum Breaker .....	7-10
Signal Lever/Headlight High-Low Beam .....	3-17
Sink – Stainless Steel .....	11-10
Skylight Shade .....	12-14
Sleeping Facilities .....	9-3
Slideout Emergency Retraction – Bedroom (Power Gear®) .....	10-9
Slideout Emergency Retraction (Power Gear®) In Wall Slideout .....	10-8
Slideout Emergency Retraction (Power Gear®) Under Floor Slideout .....	10-8
Slideout Room – Extreme Weather Precaution .....	10-5
Slideout Room Lock System .....	10-1
Slideout Room Operation – Electric .....	10-3
Slideout Room Retraction (with Power Lift Bed) .....	10-2
Slideout Room Travel Locks – Electric .....	10-1
Slideout Room Troubleshooting (Power Gear®) In Wall Slideout .....	10-6
Slideout Room Troubleshooting (Power Gear®) Under Floor Slideout .....	10-6
Slideout Rooms .....	2-7
Sliding Buffet Table and Chairs .....	9-1
SmartWheel™ Steering Wheel Control System .....	3-19
Smoke Alarm .....	2-5
Sofa/Dinette (Super Lounge) .....	9-3
Sofa/Sleeper .....	9-5
Solar Charge Panel .....	4-8
Solid Surface Countertop – Corian® .....	11-7
Solid Surface Countertop – Quartz .....	11-8
Sound Bar System .....	8-3
Specifications and Capacities .....	1-5
Stainless Steel Appliances .....	11-9

---

---

Starting and Stopping Diesel Engine .....	3-23
Steering Column Adjustment .....	3-18
Step (Entry) – Electric .....	12-9
Stepwell Cover .....	12-10
Storage Compartment Doors .....	12-14
Suspension Alignment and Tire Balance .....	3-32
Tag Axle Suspension System .....	3-15
Tailgate Package .....	4-3
Thermostat (Touch Tablet) .....	4-10
Tires .....	3-31
Toilet – Electric Flush .....	7-10
Toilet .....	7-10
Towing Guidelines .....	12-4
Trailer Wiring Connector .....	12-4
TV (Dining Buffet) – Power Lift .....	8-7
TV Antenna – Digital .....	8-8
TV Antenna – Digital .....	8-9
TV Digital Satellite System – Automatic .....	8-11
TV Digital Satellite System Wiring .....	8-10
TV Signal Amplifier .....	8-10
Undercarriage .....	11-1
Utility Light .....	7-14
Vehicle Certification Label .....	1-4
Vehicle Storage – Preparation .....	11-11
Vehicle Storage – Removal .....	11-12
Washer/Dryer – Prep Package .....	4-17
Washer/Dryer – Stackable .....	4-16
Waste Water System .....	7-11
Water Pump .....	7-3
Water System Drain Valve Locations .....	7-21
WaterLine and Tank Drain Valves .....	7-15
Weighing Your Loaded Vehicle .....	12-1
Windows .....	12-11
Windshield Washers and Wipers .....	3-31
Winterizing Optional Appliances .....	7-18
Winterizing Procedure .....	7-16
Wood Furniture and Cabinetry .....	9-12
Yamaha® Sound Bar System .....	8-5

---