



# TABLE OF CONTENTS

---

## INTRODUCTION 1

About this Manual .....	1-1
Safety Messages Used in this Manual .....	1-1
Pre-Delivery Inspection .....	1-2
Front Axle Tire Alignment .....	1-2
Service and Assistance .....	1-2
Reporting Safety Defects .....	1-2
Specifications and Capacities .....	1-4
Owner Information .....	1-6
Emergency Information .....	1-6
2007 New Vehicle Limited Warranty .....	1-7

## SAFETY/ PRECAUTIONS 2

General Warnings .....	2-1
Driving Safety .....	2-1
Propane Gas Leak Detector .....	2-1
Carbon Monoxide Warning .....	2-2
Carbon Monoxide Alarm .....	2-2
Smoke Alarm .....	2-3
Fire Extinguisher .....	2-3
Emergency Exits .....	2-4
Formaldehyde Information .....	2-5
Mold, Moisture and Your Motor Home .....	2-5
Roadside Emergency .....	2-6
Wheel Mounting Nuts (Lug Nuts) .....	2-7
Jump Starting .....	2-8
Engine Overheat .....	2-8

## DRIVING YOUR VEHICLE 3

Front Seats .....	3-1
Seat Belts .....	3-1
Child Restraints .....	3-2
Keys .....	3-2
Remote Keyless Entry .....	3-3
Automatic Door Re-lock Feature .....	3-3
Hazard Warning Flashers .....	3-3
Rearview Monitor System .....	3-3
Auto Air Conditioner/Heater .....	3-3
In-Dash Radio .....	3-4

---

Battery Boost Switch .....	3-4
Engine Cooling System .....	3-5
Lights .....	3-5
Tires .....	3-5
Suspension Alignment and Tire Balance .....	3-5
Rear Auxiliary Air Springs .....	3-6
Mountain Driving .....	3-6

**APPLIANCES & SYSTEMS 4**

Refrigerator .....	4-1
Refrigerator Service Access Compartment .....	4-2
Range Top .....	4-2
Microwave Oven .....	4-3
Range Hood .....	4-3
Systems Monitor Panel .....	4-3
Water Heater – Gas .....	4-5
Water Heater - Gas/ Electric .....	4-5
Motor Aid Water Heater .....	4-6
Pressure-Temperature Relief Valve .....	4-6
Propane Gas Furnace .....	4-7
Heat Pump .....	4-8
Ducted Roof Air Conditioning System .....	4-9
Air Conditioner Filter .....	4-9
Furnace-A/C Thermostat Operation Chart .....	4-10

**PROPANE GAS 5**

Propane Gas Supply .....	5-1
Safe Use of the Propane Gas System .....	5-2
Propane Gas Warnings and Precautions .....	5-3
Propane Gas Pressure Regulator .....	5-4
Propane Vaporization in Cold Weather .....	5-5

**ELECTRICAL 6**

Electrical Cautions .....	6-1
120-Volt AC System .....	6-1
External Power Cord .....	6-1
Power Center .....	6-3
120-Volt Circuit Breakers .....	6-4
120-Volt Receptacles (Outlets) .....	6-4
Ground Fault Circuit Interrupter .....	6-4
Electrical Generator .....	6-5
12-Volt DC System .....	6-6
Auxiliary Battery Disconnect Switch .....	6-7
House Battery Access .....	6-7

---

---

Battery Care .....	6-7
12-Volt House Fuses and Circuit Breakers .....	6-9
<b>PLUMBING 7</b>	
Fresh Water System .....	7-1
Water Pump .....	7-2
Disinfecting Your Fresh Water System .....	7-3
Shower Hose Vacuum Breaker .....	7-5
Exterior Shower / Wash Station .....	7-5
Toilet .....	7-5
Waste Water System .....	7-5
Holding Tank Heater .....	7-7
Water Line and Tank Drain Valves .....	7-7
Water Heater Bypass Winterization Valve .....	7-8
Water System Drain Valve Locations .....	7-14
<b>ENTERTAINMENT 8</b>	
TV – 12-Volt LCD .....	8-1
Audio-Video System Basic Operation .....	8-1
DVD Player with Deluxe Sound .....	8-2
TV Sound through Deluxe Speakers .....	8-3
Dash Radio through Deluxe Sound Speakers .....	8-3
Cable TV Hook-Up .....	8-4
TV Satellite System Wiring .....	8-5
<b>FURNITURE &amp; SOFTGOODS 9</b>	
Sleeping Facilities .....	9-1
Front Bunk .....	9-1
Rear Bunk .....	9-2
Couch/Bed Conversion .....	9-2
Dinette/Bed Conversion .....	9-3
Day/Nighter Pleated Blinds .....	9-4
Wood Furniture and Cabinetry .....	9-4
<b>SLIDEOUT ROOM 10</b>	
Slideout Room Operation – Electric .....	10-1
Slideout Room – Extreme Weather Precaution .....	10-3
Slideout Emergency Retraction .....	10-3
General Slideout Care .....	10-3
<b>MAINTENANCE &amp; STORAGE 11</b>	
Sealants .....	11-1
Roof .....	11-1
Underbody .....	11-1
Exterior Finish .....	11-2

---

---

Care of Appliques and Decals .....	11-3
Plastic Parts - Cleaning .....	11-3
Exterior Lights .....	11-4
Interior Softgoods .....	11-4
Ceiling Fabric Care .....	11-5
Cabinetry .....	11-6
Tables and Countertops .....	11-6
Galley Sink .....	11-6
Range and Refrigerator .....	11-6
Bathroom .....	11-6
Doors and Windows .....	11-7
Day/Nighter Pleated Blinds – Care/Adjustment .....	11-7
Preparing Vehicle for Storage .....	11-7
Removal from Storage .....	11-8
Coach Maintenance Chart .....	11-10
Recommended Sealant Application .....	11-13

**MISCELLANEOUS 12**

Loading the Vehicle .....	12-1
Roof Loading .....	12-1
Weighing Your Loaded Vehicle .....	12-1
Car or Trailer Towing .....	12-3
Trailer Wiring Connector .....	12-4
Towing Guidelines .....	12-4
Electric Entrance Step .....	12-5
Overhead Reading Light Switch .....	12-5
Windows .....	12-6
Skylight .....	12-6
Power Roof Ventilator .....	12-7
Roof Ladder .....	12-8
Awning & Door Props .....	12-9
Effects of Prolonged Occupancy .....	12-9

---

## SECTION 1 - INTRODUCTION

---

Congratulations! We welcome you to the exciting world of motor home travel and camping. You will find it convenient and enjoyable to have all the comforts of home and still enjoy the great outdoors wherever you choose to go. Your motor home has been carefully designed, engineered and manufactured to provide years of enjoyment.

Before sliding into the driver's seat, please become familiar with operations and features. In addition, spend some time with the dealer when you take delivery to learn all you can about your new motor home.

---

---

### ABOUT THIS MANUAL

This operator manual was prepared to aid you in the proper care and operation of the vehicle and equipment.

Please read this manual completely to understand how everything in your coach works before taking it on its "maiden voyage."

*NOTE: This manual describes many features of your motor home and includes instructions for its safe use.*

*This manual, including photographs and illustrations, is of a general nature only.*

***Some equipment and features described or shown in this manual may be optional or unavailable on your model.***

*Because of Winnebago Industries' continuous program of product improvement, it is possible that recent product changes and information may not be included.*

*The instructions included in this manual are intended as a guide, and in no way extend the responsibilities of Winnebago Industries beyond the standard written warranty as presented in this manual.*

*The descriptions, illustrations, and specifications in this manual were correct at the time of printing. We reserve the right to change specifications or*

*design without notice, and without incurring obligation to install the same on products previously manufactured.*

The materials in your InfoCase contain warranty information and operating and maintenance instructions for the various appliances and components in your motor home.

*NOTE: Many of the instruction sheets and manuals for the various appliances and components have been incorporated into the Operator Manual Supplement for your convenience.*

*Please read the FAQ in section 1 of the Operator Manual Supplement for more details.*

Throughout this manual, frequent reference is made to the vehicle chassis manual that is provided by the manufacturer of the chassis on which this motor home is built.

Consult the chassis manual for operating, safety and maintenance instructions pertaining to the chassis section of the motor home.

---

---

### SAFETY MESSAGES USED IN THIS MANUAL

Throughout this manual, certain items are labeled Danger, Warning, Caution or Note. These terms alert you to precautions that may involve damage to your vehicle or a risk to your personal safety. Read and follow them carefully.



DANGER indicates a directly hazardous situation which, if not avoided, will result in death or serious personal injury.

 **WARNING**

WARNING indicates a potentially hazardous situation which, if not avoided, could result in death or serious personal injury.

 **CAUTION**

CAUTION indicates a potentially hazardous situation which, if not avoided, could result in damage mainly to equipment or property, but in some cases may also result in minor or moderate personal injury.

*NOTE: A 'Note' is not necessarily safety related but indicates a recommendation or special point of information that could assist in understanding the use or care of a feature item.*

---

---

## PRE-DELIVERY INSPECTION

This motor home has been thoroughly inspected before shipment. Your dealer is responsible for performing a complete pre-delivery inspection of the chassis and all motor home components.

As a part of the pre-delivery inspection procedure, the dealer is responsible for road testing the motor home; noting and correcting any problems before delivery.

---

---

## FRONT AXLE TIRE ALIGNMENT

We recommend that you have the front suspension and steering alignment checked and adjusted after you have fully loaded the vehicle according to your needs. Thereafter, have alignment inspected periodically to maintain vehicle steering performance and prevent uneven tire wear.

---

---

## SERVICE AND ASSISTANCE

Your dealer will be glad to provide any additional information you need, as well as answer any questions you might have about operating the equipment in your motor home. When it comes to service, remember that your dealer knows your vehicle best and is interested in your satisfaction. Your dealer will provide quality maintenance and any other assistance that you may require during your ownership of this vehicle.

If you need warranty repairs while traveling you may take your motor home to any authorized Winnebago or Itasca dealership and request their assistance.

See the Motor Home Service Dealer directory in your InfoCase.

---

---

## REPORTING SAFETY DEFECTS

If you believe that your vehicle has a defect which could cause a crash or could cause injury or death, you should immediately inform the National Highway Traffic Safety Administration (NHTSA) in addition to notifying Winnebago Industries, Inc.

If NHTSA receives similar complaints, it may open an investigation, and if it finds that a safety defect exists in a group of vehicles, it may order a recall and remedy campaign. However, NHTSA cannot become involved in individual problems between you, your dealer, or Winnebago Industries.

To contact NHTSA, you may either call the Vehicle Safety Hotline toll-free at 1-888-327-4236 (TTY: 1-800-424-9153) or go to their website at <http://www.safercar.gov> or write to:

Administrator, NHTSA  
400 Seventh St SW  
Washington, D.C. 20590

You can also obtain other information about motor vehicle safety from the NHTSA website at <http://www.safercar.gov>

### VEHICLE CERTIFICATION LABEL

This label is affixed to the lower driver side armrest panel, driver door or the driver side door jamb, depending on model. It contains vehicle identification numbers and other important reference information.

MANUFACTURED BY		INCOMPLETE VEHICLE MANUFACTURED	
		BY	<u>1</u> <u>2</u>
GAWR: <u>3</u>		GVWR <u>4</u> LB	KG
SUITABLE TIRE AND RIM CHOICE		COLD INFLATION PRESSURE	
FRT	<u>5</u> LB	TIRE	<u>6</u>
RR	<u>5</u> LB	RIM	<u>7</u>
	KG		<u>8</u> PSI
	KG		KPA
THIS VEHICLE HAS BEEN COMPLETED IN ACCORDANCE WITH THE PRIOR MANUFACTURERS' IVD, WHERE APPLICABLE. THIS VEHICLE CONFORMS TO ALL APPLICABLE FEDERAL MOTOR VEHICLE SAFETY STANDARDS IN EFFECT ON THE DATE OF MANUFACTURE SHOWN ABOVE.		SING <u>9</u>	
SERIAL NO. <u>10</u>		VIN <u>11</u>	
TYPE <u>12</u>	MODEL <u>13</u>	COLOR <u>14</u>	

#### EXPLANATION OF DATA

1. Chassis manufacturer.
2. Chassis manufacture date.
3. Month and year of manufacture at Winnebago Industries.
4. Gross Vehicle Weight Rating: Total permissible weight of the vehicle, including driver, passengers, total cargo carried (including all liquids) and equipped with all options.
5. Gross Axle Weight Rating: Total permissible weight allowed for the front and rear axles (listed in pounds and kilograms).
6. Suitable Tire Choice: Tires recommended to meet handling and safety requirements. When replacing any of the tires on your vehicle, always replace with a tire that meets these specifications.
7. Suitable Rim Choice: Wheel rims recommended to meet handling and safety requirements. When replacing any of the rims on your vehicle, always replace with a rim that meets these specifications.
8. Cold Inflation Pressure: Inflation pressures at Gross Axle Weight Ratings recommended (while Cold) for the tires originally equipped on your vehicle. These pressure levels must be maintained to assure proper handling, safety and fuel economy.
9. Rear Axle Wheel Configuration: Single or Dual as it relates to the inflation.
10. Serial Number: This is the serial number assigned to the completed vehicle by Winnebago Industries.
11. Vehicle Identification Number (VIN): This number identifies the chassis on which the motor home is built. The 10th digit of the VIN designates the chassis model year. (6=2006, 7=2007, etc.). This information is useful when ordering chassis repair parts.
12. Type: States the NHTSA designated usage classification for your motor home. MPV signifies a Multi-purpose Passenger Vehicle.
13. Model: Lists the Winnebago product model number of your vehicle.
14. Color: Signifies the color code number of the decor used throughout the vehicle. This number is necessary for ordering replacement cushions, curtains, carpet, etc.

**SPECIFICATIONS AND CAPACITIES**

<b>Model</b>	<b>23B</b>	<b>23H</b>	<b>23J</b>
<b>Length</b>	23' 5"	23' 5"	23' 5"
<b>Exterior Height<sup>1</sup></b>	10' 9"	10' 9"	10' 9"
<b>Exterior Width</b>	7' 6.25"	7' 6.25"	7' 6.25"
<b>Exterior Storage<sup>2</sup> (cu. ft.)</b>	37.9	17.8	25.3
<b>Awning Length</b>	10'	10'	10'
<b>Interior Height</b>	6' 8"	6' 8"	6' 8"
<b>Interior Width</b>	7' 3"	7' 3"	7' 3"
<b>Freshwater Capacity w/Heater<sup>3</sup> (gal.)</b>	33	34	34
<b>Holding Tank Capacity - Black/Gray<sup>3</sup> (gal.)</b>	30/32	33/32	31/38
<b>LP Capacity<sup>4</sup> (gal.)</b>	18	18	18
<b>Fuel Capacity (gal.)</b>	26.4	26.4	26.4
<b>GCWR<sup>5</sup> (lbs.) †</b>	13,700	13,700	13,700
<b>GVWR (lbs.)</b>	10,200	10,200	10,200
<b>GAWR - Front (lbs.)</b>	3,859	3,859	3,859
<b>GAWR - Rear (lbs.)</b>	7,056	7,056	7,056
<b>Wheelbase</b>	159"	159"	159"

SEE NOTES ON FOLLOWING PAGE.



**Specifications and Capacities Notes:**

**Dodge® Sprinter Chassis** - 2.7L CDI 5-cylinder, turbo-diesel, 154-hp, automatic 5-speed transmission w/tip shift, 4-wheel ABS w/skid control, 150-amp. alternator, dual rear wheels, **Trailer Hitches** 3,500-lb. drawbar/350 lbs. maximum vertical tongue weight & 6-pin wiring connector, **Wheelcovers** 16.0" (4)

<sup>1</sup>The height of each model is measured to the top of the tallest standard feature and is based on the curb weight of a typically equipped unit. The actual height of your vehicle may vary by several inches depending on chassis or equipment variations. Please check with your dealer for further information.

<sup>2</sup>The load capacity of your motor home is designated by weight, not by volume, so you cannot necessarily use all available space when loading your motor home.

<sup>3</sup>Capacities are based on measurements prior to tank installation. Slight capacity variations can result due to installation applications.

<sup>4</sup>Capacities shown are tank manufacturer's listed water capacity (W.C.). Actual filled LP capacity is 80% of listing due to overfilling prevention device on tank.

<sup>5</sup>Actual towing capacity is dependent on your particular loading and towing circumstances, which includes the GVWR, GAWR, and GCWR as well as adequate trailer brakes. Please refer to the chassis operator's manual of your vehicle for further towing information.

† See "Towing Guidelines" in Miscellaneous section.

---

---

**OWNER INFORMATION**

Owner's Name \_\_\_\_\_

Street Address \_\_\_\_\_

City, State/Province, and Zip \_\_\_\_\_

Motor Home Serial Number \_\_\_\_\_

Vehicle Chassis Identification Number (VIN) \_\_\_\_\_

Vehicle Mileage at Time of Delivery \_\_\_\_\_

Selling Dealer Name and Address \_\_\_\_\_

**EMERGENCY INFORMATION**

**YOUR WINNEBAGO INDUSTRIES DEALER**

Name \_\_\_\_\_

Address \_\_\_\_\_

Contact Person \_\_\_\_\_

Phone \_\_\_\_\_

**CHASSIS DEALER/SERVICE CENTER**

Name \_\_\_\_\_

Address \_\_\_\_\_

Contact Person \_\_\_\_\_

Phone \_\_\_\_\_

**INSURANCE POLICY**

Company \_\_\_\_\_

Policy Number \_\_\_\_\_

Phone \_\_\_\_\_

**2007 NEW VEHICLE LIMITED WARRANTY  
WINNEBAGO INDUSTRIES, INC.**



**WARRANTY COVERAGE TO OWNER**

Winnebago Industries, Inc. of Forest City, Iowa, ("Winnebago") warrants each new Winnebago and Itasca recreational motor home to the owner for use in the U.S.A. and Canada as follows:

**BASIC LIMITED WARRANTY**

**WINNEBAGO'S RESPONSIBILITY**

Any part of the vehicle subject to this warranty that is found to be defective in material or workmanship under normal use and maintenance will be repaired or replaced at Winnebago's option without charge to the customer for parts or labor upon notice of the defect.

**WARRANTY PERIOD**

The basic Warranty Period is 12 months or 15,000 miles (24,135 kilometers), on the odometer, whichever occurs first. The Warranty Period for all coverages begins on the date the vehicle is delivered to the first retail purchaser or first placed in service as a demonstrator or company vehicle.

**ONLY WARRANTY**

This limited warranty is the only warranty made or authorized by Winnebago. Winnebago makes no other promises, representations or warranties concerning the vehicle or other matters set forth herein. Winnebago does not authorize any person to create for it any other obligations or liability in connection with this vehicle.

**DEALER'S REPRESENTATIONS EXCLUDED**

Winnebago shall not be bound by any undertaking, representation, or warranty made by any dealers selling its product to any purchaser of its products.

**EXCLUSIVE REMEDY**

THE PERFORMANCE OF REPAIRS IS THE EXCLUSIVE REMEDY UNDER THIS LIMITED WARRANTY OR ANY IMPLIED WARRANTY. ANY IMPLIED WARRANTY OF MERCHANTABILITY OR FITNESS FOR A PARTICULAR PURPOSE APPLICABLE TO THIS VEHICLE ARISING BY WAY OF STATE LAW IS LIMITED IN DURATION TO THE DURATION OF THIS WRITTEN WARRANTY AS HEREINBEFORE OR HEREINAFTER PROVIDED.

**LIMITATION ON LIABILITY**

WINNEBAGO SHALL NOT BE LIABLE FOR INCIDENTAL OR CONSEQUENTIAL DAMAGES RESULTING FROM BREACH OF THIS WRITTEN WARRANTY OR ANY IMPLIED WARRANTY. SUCH DAMAGES INCLUDE, BUT ARE NOT LIMITED TO, LOSS OF TIME, INCONVENIENCE, OR OTHER CONSEQUENTIAL DAMAGE INCLUDING EXPENSE FOR GASOLINE, TELEPHONE, TRAVEL, LODGING, LOSS OR DAMAGE TO PERSONAL PROPERTY, OR LOSS OF REVENUE.

Some states do not allow limitations on how long an implied warranty will last or the exclusion or limitation of incidental or consequential damages, so the above limitations or exclusions may not apply to you.

**ITEMS NOT SUBJECT TO WARRANTY COVERAGE**

- Chassis, drivetrain and related components\*
- Wheels\*
- Tires\*
- Any other part or component covered by a written warranty issued by its manufacturer\*
- Service Items, such as Windshield Wiper Blades, Lubricants, Fluids & Filters
- Adjustments

\*These items are covered under the manufacturer's individual warranty.

**ADDITIONAL EQUIPMENT NOT COVERED**

Winnebago cannot and does not accept any responsibility in connection with any of its motor homes for additional equipment or accessories installed at any dealership or other place of business, or by any other party other than Winnebago. Such installation of equipment or accessories by any other party will not be covered by the terms of this warranty.

**36 MONTH/36,000 MILE STRUCTURAL WARRANTY**

At the expiration of the Basic Coverage and for the remainder of the period of 36 months or 36,000 miles (57,924 kilometers), on the odometer, whichever occurs first, Winnebago Industries warrants the following:

1. Structural defects of the subfloor, floor, and slide-out room assembly. Floor lamination failure and lamination failure of the subfloor panels and risers are covered by the structural warranty.
2. Body Thermo-Panel® Lamination of the sidewalls and backwall against delamination. Body Thermo-Panel® Lamination is the bonding of the exterior skin and the interior paneling to an insulating core material. Delamination (separation of layers) caused by other factors such as physical damage or failed sealants is not covered by this warranty.

This warranty gives you specific legal rights and you may also have other rights which vary from state to state.

Also, this warranty shall not apply to failures, damage or malfunctions resulting from normal wear, misuse, abuse, negligence, alteration, accident, fire, improper repair of the vehicle or failure to follow recommended maintenance requirements.

**OWNER'S RESPONSIBILITY-CARE AND MAINTENANCE**

It is the owner's responsibility to perform the care, maintenance and proper load distribution described in the operator's manual which accompanies your motor home. Any damage which results to your vehicle as a result of your failure to perform such duties, is not covered.

Damage to appearance items such as fiberglass, metal, paint, fabrics and trim, may occur during manufacturing or transporting. Normally, any factory defect or damage is corrected at the factory. In addition, dealers are obligated to inspect each vehicle upon delivery to them and prior to delivery to you. You should also immediately inspect appearance items and advise your selling dealer of any discrepancies. Damage and normal deterioration due to use and exposure is not covered by this warranty.

## OBTAINING WARRANTY REPAIRS

While any Winnebago Industries motor home dealer can perform warranty service, we recommend you return to the dealership that sold you your vehicle. If you are touring or have moved, contact any Winnebago Industries motor home dealer in the United States or Canada for warranty service.

If a part of the system covered by this limited warranty fails to function or requires service during the warranty period:

1. Promptly take the vehicle to the selling dealer for repair or inspection.
2. Written notice of defects must be given to the selling dealer and manufacturer.
3. If the dealer is incapable of making the repairs, request that he contact Winnebago Industries, Inc.
4. If, after the above steps are completed and the repair is not made, the customer should contact Winnebago Industries, Inc., 605 West Crystal Lake Road, P.O. Box 152, Forest City, Iowa 50436, Attention: Owner Relations Department (800-537-1885) and furnish the following information:
  - The complete serial number of the vehicle
  - Date of retail purchase
  - Selling dealer's name
  - Nature of the service problem, and a brief explanation of the steps or service the dealer has performed, and the results obtained. The customer may be directed to another dealer or service center for repairs to be completed, if such a dealer or service center is better able to complete the repair.

Winnebago Industries may, at its option, request the vehicle be returned to Forest City, Iowa for repair. If the customer refuses to allow repairs to be performed at the Forest City, Iowa facility, the warranty on that repair will be voided.

5. If after the above steps are completed and the repairs are not satisfactory, the customer may contact the Service Administration Manager of Winnebago Industries, and request a customer relations board meeting to resolve the problem. This action, however, is not mandatory.
6. Certain components are covered by warranties provided by individual component manufacturers. Please refer to the component's information supplied in the vehicle's InfoCase.

## COMMENCEMENT OF ACTIONS

Any action for breach of The Basic Limited or Structural Warranty or any implied warranty shall be commenced within one-year after expiration of the warranty.

## CHANGES IN DESIGN

Winnebago Industries, Inc. reserves the right to make changes in design and changes or improvements upon its products without imposing any obligation upon itself to install the same upon its products theretofore manufactured.

## NEW YORK:

If your motor home has been repaired three or more times for the same nonconformity, defect, or condition, or if your motor home has been out of service by reason of repair for twenty-one days, Section 198-a of the General Business Law of the State of New York requires you to provide written notice by certified mail, return receipt requested, to Winnebago Industries or its authorized dealer before making any claim under that section of the law. If you do have problems with your motor home, you should provide written notice to Winnebago Industries at the following address:

Winnebago Industries, Inc.  
605 West Crystal Lake Road  
P.O. Box 152  
Forest City, Iowa 50436

Attn: Owner Relations

## CALIFORNIA:

Winnebago Industries participates in the Consumer Arbitration Program for Recreation Vehicles (CAP-RV). This third-party dispute resolution program is available, at no charge to you, to settle unresolved warranty disputes for recreational vehicles. This dispute resolution program reviews eligible product and service related complaints involving warranty covered components.

To find out more about the program, or to request an application/brochure, please call the Arbitration Administration office toll-free 800-279-5343.

The CAP-RV program operates as a certified mechanism under the review of the California Arbitration Certification Program. You must utilize the arbitration program before claiming rights conferred by 15 USC section 2310 (Uniform Commercial Code) or Civil Code section 1793.22(b) (Tanner Consumer Protection Act). You are not required to use the program if you choose to seek redress by pursuing rights and remedies not created by those laws.

## SECTION 2 - SAFETY/ PRECAUTIONS

---

---

---

### GENERAL WARNINGS

- Only seats equipped with seat belts are to be occupied while the vehicle is moving.
- Make sure all passengers have seat belts fastened. Lap belts should fit low on the hips and upper thighs. The shoulder belt should be positioned snug over the shoulder.
- For pregnant women, the lap belt should be placed under the abdomen and across the upper thighs. The shoulder belt should be positioned across the center of the chest. Consult your doctor if you have any questions.
- Child restraints should be installed properly according to manufacturer's instructions. See "Child Restraints."
- All moveable or swiveling seats should be placed and locked in forward facing positions while the vehicle is moving.
- Never let passengers stand or kneel on seats while the vehicle is moving.
- Sleeping facilities are not to be utilized while vehicle is moving.
- Examine the escape window and be familiar with its operation.
- Inspect the fire extinguisher monthly for proper charge and operating condition. This should also be done before beginning a vacation or any extended trip.

---

---

### DRIVING SAFETY

- Do not attempt to adjust the driver's seat while the vehicle is moving.
- Do not adjust tilt steering in a moving vehicle.
- Do not operate the cruise control on icy or extremely wet roads, winding roads, in heavy traffic, or in any other traffic situation where a constant speed cannot be maintained.
- Use care when accelerating or decelerating on a slippery surface. Abrupt speed changes can cause skidding and loss of control.

- Driving through water deep enough to wet the brakes may affect stopping distance or cause the vehicle to pull to one side. Check brake operation in a safe area to be sure they have not been affected. Never operate any vehicle if a difference in braking efficiency is noticeable.
- Adverse weather conditions and extremes in terrain may affect handling and/or performance of your vehicle. Refer to your chassis manual for related information.

---

---

### PROPANE GAS LEAK DETECTOR

Your coach is equipped with one of the propane gas leak detectors shown below. The leak detector sounds an alarm if an unsafe amount of propane gas is present inside the coach.



Propane Gas Leak Detectors (typical)

Because propane gas is heavier than air, the leak detector is located on a cabinet face near the floor of the coach.

 **WARNING**

Never use an open flame to test for gas leaks. When testing for gas line leaks with a soapy water solution, DO NOT use a detergent containing ammonia or chlorine. These substances may generate a chemical reaction causing corrosion to gas lines, resulting in dangerous leak conditions.

**Power Connection**

The propane gas leak detector is powered by the house batteries. If the auxiliary battery switch is shut off or the battery cable is disconnected from the batteries, the alarm will not work. The propane gas leak detector fuse or circuit breaker is located in the 12-volt house electrical load center.

Because the propane gas leak detector is connected to the house battery, it is always drawing a small amount of current. Even though this current draw is slight, it could drain the house battery during storage periods when the house battery will not be charged regularly by the engine or shoreline. Turn the Aux. Batt switch OFF to avoid current drain during storage periods.

**Further Information**

See the manufacturer's information in your InfoCase for further instructions on nuisance alarms and care and testing of the propane gas leak detector.

**CARBON MONOXIDE  
WARNING**

 **WARNING**

Avoid inhaling exhaust gases, as they contain carbon monoxide, which is a colorless, odorless and poisonous gas.

The best protection against carbon monoxide entry into the vehicle body is a properly maintained engine exhaust and ventilation system. It is recommended that the exhaust system and body be inspected by a qualified motor home service center.

- Each time the vehicle is serviced for an oil change.
- Whenever a change in the sound of the exhaust system is noticed.
- Whenever the exhaust system, underbody or rear of the vehicle is damaged.

To allow proper operation of the vehicle's ventilation system, keep front ventilation inlet grill clear of snow, leaves or other obstructions at all times. **DO NOT OCCUPY A PARKED VEHICLE WITH ENGINE RUNNING FOR AN EXTENDED PERIOD.**

Do not run engine in confined areas, such as a garage, except to move vehicle into or out of the area.

**CARBON MONOXIDE ALARM**

Your coach is equipped with a carbon monoxide (CO) alarm located on the ceiling in the bedroom area. The CO alarm is powered by a 9-volt battery and has a sensor that is designed to detect toxic carbon monoxide gas fumes resulting from incomplete combustion of fuel. It will detect CO gas from any combustion source such as the furnace, gas range/oven, water heater, refrigerator, chassis engine, and electric generator engine.



Carbon Monoxide Alarm



Smoke Alarm

The following label is affixed to the smoke alarm.

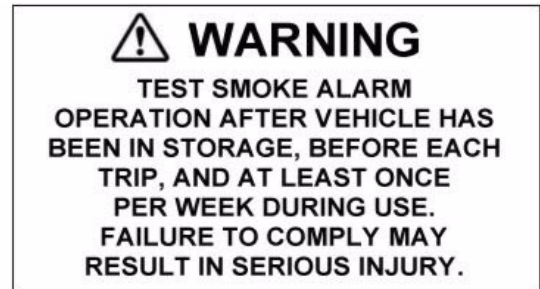
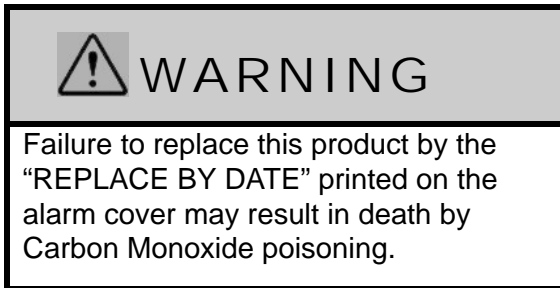

**Further Information**

Please read the information provided by the manufacturer, which is included in your InfoCase. It includes information on precautions, operational testing, and battery replacement.

**Replacement**

When replacing this alarm, we recommend replacing only with a similar model. Other brands may not be recommended for RV application.

**Further Information**

See the manufacturer’s information in your InfoCase for further instructions on battery replacement and testing of the smoke alarm.

**Replacement**

When replacing this alarm, we recommend replacing only with a similar model. Other brands may not be recommended for RV application.

We recommend obtaining a replacement from your Winnebago Industries dealer.

---



---

**SMOKE ALARM**

Your motor home is equipped with a smoke alarm located on the ceiling in the lounge area. The smoke alarm is powered by a 9-volt battery and has a sensor that is designed to detect smoke.

---



---

**FIRE EXTINGUISHER**

A dry chemical fire extinguisher is located on the wall or floor near the main entrance door.



**Fire Extinguisher**  
(typical installation - your coach may vary according to model and floorplan)

We recommend that you become thoroughly familiar with the operating instructions displayed on the side of the fire extinguisher or in the information supplied in your InfoCase.

We also recommend that you inspect the fire extinguisher for proper charge at least once a month in accordance with National Fire Protection Association (NFPA) recommendations as stated on the label.

If the charge is insufficient, the fire extinguisher must be replaced.

**! WARNING**

Do not test the fire extinguisher by discharging it. Partial discharge can cause leakage of pressure or contents which would render the unit inoperative when needed. When using the fire extinguisher, aim the spray at the base of the fire.

**Replacement**

If, for any reason, you must replace the fire extinguisher, the replacement must be the same type and size, or larger, as the one originally supplied in your coach. We recommend obtaining a replacement only from your Winnebago Industries dealer or a reliable RV parts supplier.

**EMERGENCY EXITS**

**! WARNING**

Use care when exiting emergency window, as broken glass may be present in the exit area.

**Escape Window**

The bedroom escape window is secured by two red safety latches at the bottom of the window.

To open, lift both latches up and toward the center of the window, then push outward near the bottom of the window.



Escape Window - Lift latch handles upward to open.

**Using Slider Windows As  
Emergency Exits**

Some coaches are required to have a slider window as an alternate exit. This window will be marked EXIT and have a red handled latch.





Pull latch outward to slide window open

Most slider windows along the side of any motor home can also be used as alternate emergency exits, should the need arise.

To use a slider windows as an exit, first slide the window open, then either slide the screen open or push the screen material out, depending on window construction.

---



---

## FORMALDEHYDE INFORMATION

 <b>WARNING</b>
<p>Some components in this vehicle contain formaldehyde based adhesives which may release formaldehyde fumes into the air for an unknown period of time until total dissipation occurs. Individuals who are allergic to formaldehyde gas fumes may experience irritation to eyes, ears, nose and throat. Reaction in infants may be more severe. Although long range effects are not well understood, testing to date has not revealed any serious health effects in humans at the level of emission from these products.</p>

---



---

## MOLD, MOISTURE AND YOUR MOTOR HOME

### What is Mold?

Molds are part of the natural environment. They are as old as the Earth itself. And mold spores are almost everywhere at some level waiting to grow. Mold plays a part of nature by breaking down dead organic matter such a fallen leaves and dead trees. Indoors, however, mold growth should be avoided. Molds reproduce by means of tiny spores. Those spores are invisible to the naked eye and float throughout the outdoor and indoor air. Because of the nature of the use of a motor home, it is natural for a motor home to be introduced into an environment with mold spores.

Mold is a plant and requires its own special environment to grow. That environment includes organic materials, nutrients, moisture, and proper temperature.

### How Can I Avoid Mold?

To reduce the ability for mold to grow, you must reduce what constitutes its growth environment. Mold can grow with the smallest of a nutrient base. Just small amounts of dirt or dust on the carpet can be enough to allow the mold process to begin. Keep the environment as clean as possible. Vacuum the carpet. Clean food spills thoroughly and quickly. Avoid grease buildup near the stove or sink. Clean the exhaust fan above the stove often.

Minimize moisture in your motor home and keep humidity low. Clean spills quickly. Do not allow condensation to build up. You can open windows and vents to minimize condensation. Use of the air conditioner can assist in removing moisture from the air. Avoid leaks and if leaks do occur, make repairs promptly.

Avoid bringing mold into your motor home. Plants, cloths, books, and other household items may already have mold present. It is easy to transfer mold into your motor home environment.

Monitor your motor home. Periodically check those hidden areas in corners, closets, and cabinets to assure mold is not present.

### **What if I Have Mold?**

If mold develops, clean the area with a concentrate of soap and bleach. Items that contain mold that cannot be cleaned should be removed from the vehicle.

### **Can Mold Harm Me?**

The effects of mold and airborne mold spores may cause irritation to some people. Experts disagree on the level of exposure that may cause health concerns.

### **If Mold Is Present, What Will Winnebago Industries Do?**

If Winnebago Industries determines that mold is present in the Winnebago/Itasca motor home as a result of a manufacturing defect reported to Winnebago Industries within the limited warranty period, Winnebago will clean the affected areas and/or replace affected items as it deems necessary. This is the extent of coverage provided by Winnebago Industries. Winnebago Industries, however, will not assume responsibility for mold deemed to be a result of a motor home users lack of timely and appropriate action to mitigate circumstances should a problem occur.

If Winnebago Industries determines that mold is present due to conditions it determines is not a result of a manufacturing defect found within the warranty period, Winnebago Industries will not provide any financial assistance to the repair of the condition.

© Copyright Winnebago Industries, Inc. All rights reserved.

---

---

## **ROADSIDE EMERGENCY**

Because of the size and weight of this vehicle and its tires, and the possible complications involved in tire changing, we strongly advise obtaining professional road service to change a flat tire whenever possible. However, if an

emergency requires you to change the tire yourself, please exercise extreme caution and read all tire changing information in the chassis manual.

Never get beneath a vehicle that is held up by a jack only.

### **If You Get A Flat Tire**

- DO NOT panic.
- Grip the steering wheel firmly and steer the vehicle as straight as possible. Avoid quick maneuvers. You may need to counter-steer to compensate for “pull” created by the failed tire.
- DO NOT stomp on the brake. This abruptly shifts the vehicle’s weight forward, making it nose-dive and pull toward the blown-out side.
- DO NOT jerk your foot off the accelerator. Just ease back on the accelerator slowly and gently to continue momentum. The deflated tire will slow the vehicle.
- If you must change lanes to get to a safe stopping place, use your signals to warn other motorists and change lanes smoothly and carefully after you are certain the lane is clear.
- Let the vehicle coast to a stop, gently steering to a safe stopping place off the traffic lanes of the road. Don’t worry about damaging the tire or wheel rim by driving on it. A tire or wheel replacement is cheaper than damaging the vehicle or injuring yourself.
- When you have come to a stop, activate your hazard flashers to warn other motorists, then exit the vehicle carefully.
- Set out flares or other warning devices.

Check your tires for proper inflation before each trip and at least once a month with an accurate tire gauge.

### **Recovery Towing**

When calling a professional towing service, we recommend that you advise them of your coach length and approximate front axle weight listed on your Vehicle Certification Label. This will allow the towing operator to determine the proper towing equipment to use.

We recommend that you ask for an underlift (wheel lift or frame lift) type towing assembly for safe towing.

Winnebago Industries does not assume responsibility for damage incurred while towing this vehicle.

*NOTE: Consult the chassis manual for any additional towing instructions or precautions provided by the chassis manufacturer.*

 **CAUTION**

Do not lift on bumper. Damage will result to front end body parts.

 **WARNING**

Stay out from beneath the motor home while it is suspended by the towing assembly unless the vehicle is adequately supported by safety stands. Do not allow passengers to occupy a towed vehicle.

### WHEEL MOUNTING NUTS (LUG NUTS)

The mounting bolts and nuts for the standard steel wheels are designed specifically for the type of wheel. See the following information and photos.

*Note: The Sprinter chassis manual (Daimler-Chrysler Corp. #81-326-0599, First Edition) does not show wheel lug nut information for the 10,200 GVWR chassis that this coach is built on. See your chassis manual along with the following supplemental information.*

### Steel Wheels

- The lug nut for steel wheels is a non-plated, hat-shaped, flange nut. The accompanying dome-shaped, split cone washer should be positioned 'dome first' onto the wheel stud before the nut as shown.



Steel Wheel Front

Steel Wheel Rear



Steel Wheel Lug Nut and Washer (Hex Flange Nut with Split Cone Washer)

### Spare Tire Mounting

The spare tire is mounted to the back of the coach as shown.



---

---

## JUMP STARTING

If your coach will not start from the chassis battery, try using the battery boost switch to divert power from the house batteries to the starter. (See either “Battery Boost Switch” or “Aux Start Switch.”)

If you wish to try jump starting the engine using another vehicle or booster system, see your chassis manual for connecting jumper cables to the automotive electrical system.



### WARNING

Do not attempt to push start this vehicle. Damage to the transmission or other parts of the vehicle will occur.

---

---

## ENGINE OVERHEAT

If you see or hear steam escaping from the engine compartment or have any other reason to suspect an extreme engine overheating condition, pull the vehicle over to the roadside as soon as it is safe to do so, stop the engine and get all passengers out of the vehicle.



### WARNING

Operating a vehicle under a severe overheating condition can result in damage to the vehicle and may result in personal injury.

For information on what to do in case of overheating, consult your chassis manual.

## SECTION 3 - DRIVING YOUR VEHICLE

---

The information in this section refers only to features installed or adapted to the dash and driver compartment area by Winnebago Industries. It also includes passenger seating in the living area of the coach.

See your chassis manual for all original chassis related controls, instrumentation, switches and other features. This includes items such as cruise control, climate controls, gauges, wipers, lights, front seats and three-point safety belts, etc.

---

---

### FRONT SEATS

The driver and co-pilot seats may be independently adjusted to suit individual preference.

See your chassis manual for instructions on seat adjustments.

---

---

### SEAT BELTS

Seats intended for occupancy while the vehicle is in motion are equipped with seat belts for the protection of the driver and passengers.

#### Lap Belts

The lap belts must be worn as low as possible and fit snugly across the hip area. Always sit erect and well back into the seat. To gain full protection of the safety belt, never let more than one person use the same safety belt at any one time, and do not let the safety belts become damaged by pinching them in the doors or in the seat mechanism. After any serious accident, any seat belts which were in use at the time must be inspected and replaced if necessary.

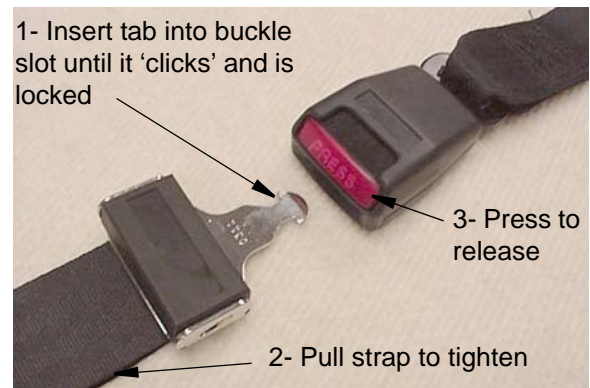

#### Adjustment:

To lengthen belt, swivel the tab end at a right angle to belt and pull strap to desired length. To shorten, pull loose end of belt.

#### To Fasten:

Be sure belt is not twisted. Grasp each part of the belt assembly and push tongue into buckle. Adjust to a snug fit by pulling the loose end away from the tongue.

#### To Release:

Press button in center of buckle and slide tongue out of buckle.

 <b>WARNING</b>
Snug and low belt positions are essential. This will ensure that the force exerted by the lap belt in a collision is spread over the strong hip area and not across the abdomen, which could result in serious injury. Only seats equipped with seat belts are to be occupied while vehicle is in motion.

#### Lap/Shoulder Belts

See your chassis manual for instructions on proper fastening, adjustment and releasing of lap/shoulder belts.

### Seat Belt Care and Cleaning

- Be careful not to damage the belt webbing and hardware. Take care not to pinch them in the seat or doors.
- Inspect the belts and hardware periodically. Check for cuts, frays, and loose parts. Damaged parts should be replaced. Do not remove or modify the belt system.
- Keep belts clean and dry. If the belts need cleaning, use only a mild soap and water solution. Do not use hot water. Do not use abrasive cleaners, bleach or dyes. These products may weaken the belts.
- Replace any belt assembly that was used during a severe impact. Replace the complete assembly even if damage is not apparent.

---

---

### CHILD RESTRAINTS

A properly installed and secured child restraint system can help reduce the chance or severity of personal injury to a child in an accident or during a sudden maneuver. Children may have a greater chance of being injured in an accident if they are seated in a child restraint system which is not properly secured.

A child restraint system is designed to be secured in a vehicle seat by a lap belt or the lap belt portion of a lap-shoulder belt.

When purchasing a child restraint system, follow these guidelines:

1. Look for the label certifying that it meets all applicable safety standards.
2. Make sure that it will attach to your vehicle and restrain your child securely and conveniently so that you are able to install it correctly each time it is used.
3. Be certain that it is appropriate for the child's height, weight and development. The instructions and/or the regulation label attached to the restraint typically provides this information.
4. Review the instructions for installation and use of the restraint. Be sure that you understand them fully and can install the restraint properly and safely in your vehicle.

### Tether Anchor Loop

If your coach has a dinette, it may be equipped with a child seat tether anchor loop located on the floor directly behind the forward facing dinette seat.



The dinette table must be in the lowered position when a child seat is in use.



1. Lower the dinette table.
2. Route the tether over the top of the dinette seat back and hook it to the anchor loop on the floor.
3. Fasten the lap belt.

See the child seat maker's specific instructions for proper attachment and adjustment of the tether and seat belts.

---

---

### KEYS

Your motor home is supplied with several keys. In addition to the chassis manufacturer's ignition key, you receive keys for the entrance door and exterior compartment doors.

Keys have an identification number, either a small metal tag or stamped into the key head. These numbers are recorded on the vehicle's

component model/serial sheet which is included in your InfoCase. In case keys are lost or stolen, your dealer or a locksmith can provide you with duplicate keys or modify the locks.

---



---

### REMOTE KEYLESS ENTRY

The keyless entry system is chassis supplied for the cab doors; however, we have also connected the coach entry door lock to this system. This means your keyless remote transmitter will lock and unlock the entry door as well as the cab doors.

---



---

### AUTOMATIC DOOR RE-LOCK FEATURE

The doors are programmed to re-lock automatically if either one of the front (driver or passenger) doors is not opened within 30-40 seconds after unlocking with the keyless remote transmitter. This is a chassis designed safety feature which cannot be reprogrammed.

This means if you use the keyless remote to unlock and enter the coach through the side entry door, you must also immediately open one of the front doors to disable the re-lock feature and avoid a potential lockout situation. If you open only the entrance door and then shut it behind you, the coach will be locked.

Make a habit of having the keys with you when you exit the coach and of opening the passenger door first before opening the entry door whenever unlocking with the keyless remote.

### Further Information

See your chassis manual for detailed instructions on using the Remote Keyless Entry system and for battery replacement information.

---



---

### HAZARD WARNING FLASHERS

The hazard warning flashers provide additional safety when the vehicle must be stopped on the side of the roadway and presents a

possible hazard to other motorists. When the flashers are on, it serves as a warning to other drivers.

See your chassis manual for instructions on activating, operating and canceling hazard warning flashers.

---



---

### REARVIEW MONITOR SYSTEM -If Equipped

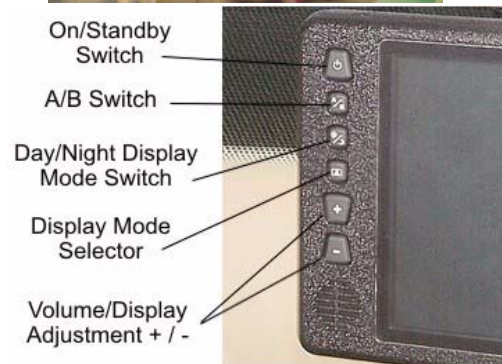

If your motor home is equipped with this optional system, refer to the InfoCase for specific instructions provided by manufacturer.

---



---

### AUTO AIR CONDITIONER/ HEATER

See your chassis manual for operating information on driver and passenger comfort controls – air conditioner, heater, defroster and ventilation.

*NOTE: The dash air conditioner is not designed to cool the entire interior of the coach, but is intended only to provide cooling the cab area.*

---

---

## IN-DASH RADIO

Please refer to the radio manufacturer's operating guide in your InfoCase for detailed instructions on programming preset station buttons and using this full-featured radio/audio system.



in-Dash Radio

## Satellite Radio

### -If Equipped

Your coach may be equipped with a Sirius satellite radio receiver that plays through your radio.

See the receiver manufacturer's information in your InfoCase for programming and operating instructions.

*NOTE: If your Sirius tuner is not activated, follow the instructions in the radio owners manual in your InfoCase for the phone number to call and procedure to access the Sirius Tuner ID Number (ESN).*

## Radio Power Switch

The radio power switch on the dash lets you connect the dash radio to the coach batteries when the ignition switch turned off for listening while parked. This prevents accidental draining of the chassis battery by prolonged use of the radio.



- Press HOUSE to listen to the radio while parked without the ignition key on.
- Press ENGINE to listen while driving.

---

---

## BATTERY BOOST SWITCH

This switch can be used to draw emergency starting power from the house batteries to start the engine if the chassis battery is discharged.

Press and hold in the ON position while turning ignition key for emergency starting power.

*NOTE: The Aux. Battery Disconnect switch near the entrance door must be ON and house batteries must be sufficiently charged for this feature to work.*



Press and hold in the ON position while turning ignition key for emergency starting power.



---



---

## ENGINE COOLING SYSTEM

Do not remove the radiator cap while engine and radiator are still hot. Always check coolant level visually at the see-through coolant reservoir.

*NOTE: Your chassis engine cooling system is filled with special extended-life coolant that is not the same as common anti-freeze available at retail outlets. The coolant system **MUST** be refilled or topped up with the same type of coolant as equipped to maintain the special long-life properties.*

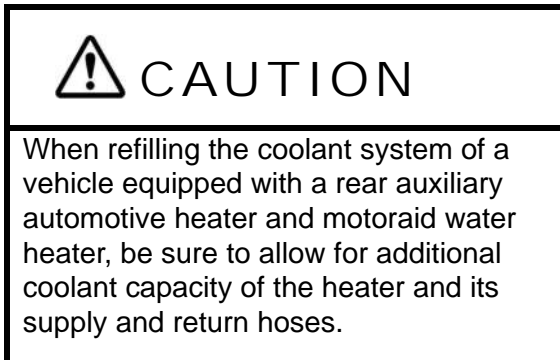

Refer to your chassis manual for information and precautions on filling, servicing and checking the fluid level.

---



---

## LIGHTS

All exterior lights should be checked for proper operation each time the vehicle is prepared for a trip. Any bulbs which fail to light should be checked and replaced, when necessary, with a new bulb of the same size. A failure of more than one light, such as both taillights not operating, may indicate a burned out fuse. Check fuse and replace with one of the same rating when necessary. If a fuse is not the cause of the problem, the wiring system should be checked immediately by an authorized service center.

Refer to your chassis manual for further information.

---



---

## TIRES

Improper tire pressure can result in tire overloading and abnormal wear and also affects handling, ride characteristics and fuel economy.

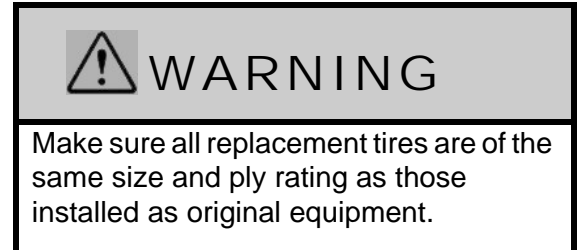

See your Vehicle Certification Label for tire information.

---



---

## SUSPENSION ALIGNMENT AND TIRE BALANCE

The front suspension and steering system of this vehicle was factory aligned using highly accurate equipment prior to delivery to the dealership. However, alignment should be checked and adjusted, after you have fully loaded the motor home according to your personal needs. Thereafter, the alignment should be periodically inspected to help prevent uneven tire wear.

Any excessive or abnormal tire wear may indicate worn or misaligned suspension or steering, unbalanced tire or other tire/suspension problem.

Alignment can be affected by worn steering/suspension parts or by incidents which happen during driving, such as hitting a curb, pothole or railroad track, etc. Improper alignment can cause tires to roll at an angle and wear unevenly. It may also cause the vehicle to “pull” to the right or left. Have your dealer inspect your vehicle’s suspension and steering components periodically for misalignment or wear.

Out-of-balance tires will not roll smoothly and can lead to vibrations and uneven tread wear such as cupping and flat spots. Tires may need to be balanced if uneven wear is detected or if ride comfort decreases noticeably.

See your chassis manual for further information.

---

---

## REAR AUXILIARY AIR SPRINGS

### -If Equipped

The rear air ‘helper’ springs (also commonly called ‘air bags’) are an enhancement to the standard chassis suspension system to provide adjustable load and ride conditions. *This feature is not intended to increase the load capacity of the rear axle or the vehicle.*

The air bag fill valves are located on a panel in the generator compartment behind the right rear tires.



Rear Air Spring Fill Valves  
located on panel in generator compartment

Min. Operating Pressure: . . . . . 20 psi  
Max. Operating Pressure: . . . . . 75 psi

### **Air Spring Adjustment (Air Spring Manufacturer’s Recommendation)**

Start with minimum pressure (20 psi) and load the coach with your belongings for the trip.

Drive down a familiar stretch of road to evaluate handling characteristics. Have a passenger accompany you in the furthest rearward belted seating position to evaluate the ride characteristics.

Add pressure in 5 psi increments on both sides and repeat the test drive until the ride is determined to be ‘rough’ or ‘harsh’, then let out

about 5 psi on each side. This should result in the best combination of ride and handling characteristics for the load.

**Too much** air pressure in the air springs will result in too firm a ride.

**Too little** air pressure will not provide the improvement in handling that is possible and will allow the air spring to ‘bottom out’ over rough road conditions.

The air bags can be adjusted independently if necessary to equalize a load, however we recommend maintaining the same pressure in both air bags whenever possible to ensure that the vehicle remains level.

### **Periodic Checking**

Check and adjust the air bag pressure periodically to maintain optimal ride and handling characteristics according to cargo weight. It is recommended to check the air spring pressure whenever you check tire air pressure.

*NOTE: Keep in mind that, because of the small capacity of the air sleeves, a minimum of 5 pounds of pressure can be lost each time air pressure is checked. The burst of air you hear when pressing an air gauge to the valve is air pressure escaping, so remember to compensate for this pressure loss.*

 <b>CAUTION</b>
If the vehicle must be lifted by the frame, all air pressure must be released from the air springs.

---

---

## MOUNTAIN DRIVING

Special techniques must be used when driving in mountainous or hilly country.

### **Climbing A Hill**

The transmission will automatically downshift as needed to climb most hills. If the hill is long or very steep, however, you may need

to manually shift to a lower gear to keep the transmission from repeatedly upshifting and downshifting. Select the lowest adequate gear range for the duration of the incline. See your chassis manual for specific information.

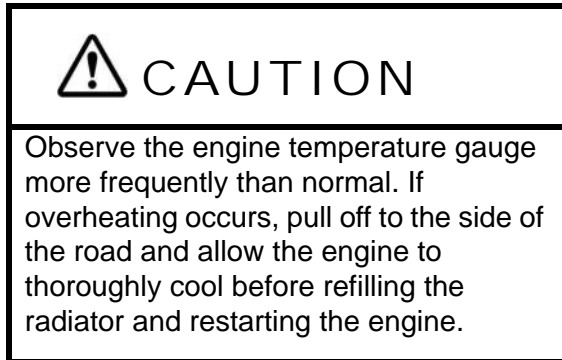

### **Descending A Hill**

When going down a long grade, you may need to manually shift to a lower gear rather than keeping your foot on the brake pedal. A lower gear will allow the engine to provide a degree of braking action. Holding your foot on the brake pedal for an extended period may cause brakes to overheat, which could cause you to lose control of the vehicle. See your chassis manual for specific information.



## SECTION 4 - APPLIANCES & SYSTEMS

The appliances installed in your motor home are manufactured by reputable RV appliance makers and have been tested by independent laboratories to meet all applicable standards and codes set for RV appliances.

---

---

### REFRIGERATOR

The refrigerator in your coach can operate from either of two energy sources available to the motor home:

- 120-Volt AC electric
- Propane gas

To be able to use both types of energy, the refrigerator does not have a compressor like household refrigerators. Instead, it uses an ammonia-water solution for cooling. Basically, ammonia vapor is distilled from the solution by heat produced from either propane gas flame or electrical heat element. The ammonia vapor is then carried to the finned condenser where it liquefies. The liquid then flows to an evaporator where it creates cooling by evaporation. The ammonia circulates back into the water solution and the cooling cycle continues.

### Leveling

Before operating the refrigerator when the motor home is stationary, place a small level on the bottom of the refrigerator and make certain the unit is level. If over 1/2 of the bubble is inside the circle in any direction, the coach is level enough for continuous operation of the refrigerator while parked.



Place bubble level in bottom of refrigerator

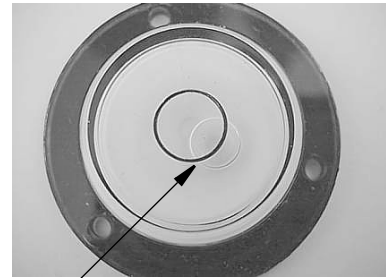

Bubble must be at least 1/2 inside circle

Normal vehicle leveling to provide comfort for the occupants is satisfactory for refrigerator operation.

### CAUTION

To prevent permanent damage to the refrigerator cooling unit, turn the refrigerator off if the vehicle will be parked on an incline of over 3° side-to-side or 6° front-to-rear (such as steep driveways or parking lots, etc.) for more than one hour.

### Basic Operation

Slide the control switches to the operating positions described and observe the indicator lights.



- **Gas-** Refrigerator will operate on gas from the propane tank if the main valve is open and the tank contains gas.

- **Auto-** Refrigerator will operate on 120-VAC household current if the shoreline is connected or the auxiliary generator is running. If electricity is lost, it will automatically switch over to Gas operation if gas is available.
- **Temperature Setting-** Start at the ‘coldest’ setting to ensure coldest temperature in the freezer compartment, then adjust warmer as necessary after cold\* food has been added.
- **‘On’ Indicator Light-** Glows steady when refrigerator is operating properly.
- **‘Gas’ Indicator Light-** Will flash if gas is not available. To operate the refrigerator you must provide 120VAC then switch to Auto operation.

*\* The refrigerator will retain temperature more efficiently if food is cold before placing inside.*

**Further Information**

For further information and operating cautions, see the refrigerator operating instructions included in your InfoCase.

---

---

**REFRIGERATOR SERVICE  
ACCESS COMPARTMENT  
(Exterior)**

The exterior refrigerator service compartment allows access to the rear of the refrigerator for inspection, maintenance and service.

**To Open:**

1. Use a screwdriver or coin to turn the latch knobs to the vertical position as shown.



Refrigerator Access Door Latches

2. Remove the door from the opening.

**To Close:**

1. Replace the door into the opening.
2. Push the latch knobs in while turning to the horizontal position as shown.

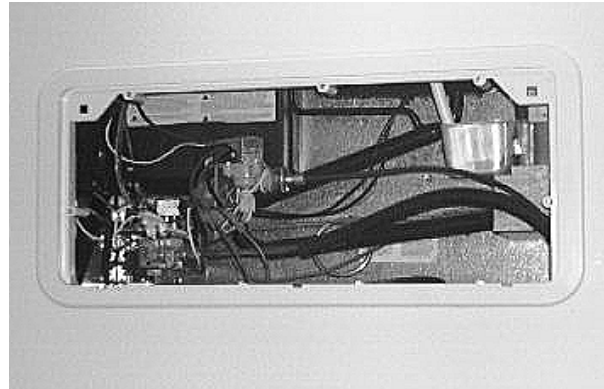

Refrigerator Access Compartment

---

---

**RANGE TOP**

The range in your motor home operates on propane gas and will provide most of the functions of the range in your home.



**To Light Range Top Burners**

- Turn the desired burner knob to HI LITE position
- Immediately spin the IGNITOR knob clockwise at least one full turn to light the burner

**Avoiding Asphyxiation**

The following warning label has been located in the cooking area to remind you to provide an adequate supply of fresh air for combustion.

**⚠ WARNING**

IT IS NOT SAFE TO USE  
COOKING APPLIANCES  
FOR COMFORT HEATING

Cooking appliances need fresh air for safe operation. Before operation

1. Open overhead vent or turn on exhaust fan.
2. Open window

FAILURE TO COMPLY COULD RESULT IN DEATH OR SERIOUS INJURY.

Unlike homes, the amount of oxygen supply is limited due to the size of the recreational vehicle, and proper ventilation when using the cooking appliances avoids dangers of asphyxiation.

It is especially important that cooking appliances not be used for comfort heating, as the danger of asphyxiation is greater when the appliance is used for long periods of time.

**FAILURE TO COMPLY COULD RESULT IN DEATH OR SERIOUS INJURY.**

**⚠ WARNING**

Portable fuel-burning equipment including wood and charcoal grills and stoves, shall not be used inside the recreational vehicle. The use of this equipment inside the recreational vehicle can cause fires or asphyxiation.

### Further Information

See *USING THE COOKTOP* in the appliance manufacturer's *RV Cooking Appliance Use and Care* guide in your InfoCase.

### MICROWAVE OVEN

Refer to the microwave oven manufacturer's information provided in your InfoCase for complete operating instructions.

### RANGE HOOD

The range hood vent draws cooking odors and airborne grease particles into the filtration grid and recirculates the air or vents it to the outside of the coach.

A light on the underside of the hood provides illumination for cooking and food preparation.

### Further Information

See the manufacturer's information provided in your InfoCase for instructions on replacement of light bulbs and replacement or cleaning of grease filter elements.

### SYSTEMS MONITOR PANEL

The Systems Monitor Panel provides a convenient central location for checking the condition of all utility systems in your coach.



At the touch of a button this panel will display the fresh water and holding tank levels, propane gas tank level, plus the house battery condition. You can start the generator or turn on the water pump and water heater. Indicator lights tell you if the water pump is on or if the water heater pilot light is out.

### Water And Holding Tank Levels

Press and Hold the "Levels Test" switch to show approximate level on the monitor lights.



The approximate fluid levels are measured by electronic sensors on the sides of the tanks. There is generally more fluid in a tank than indicated on the monitor panel.

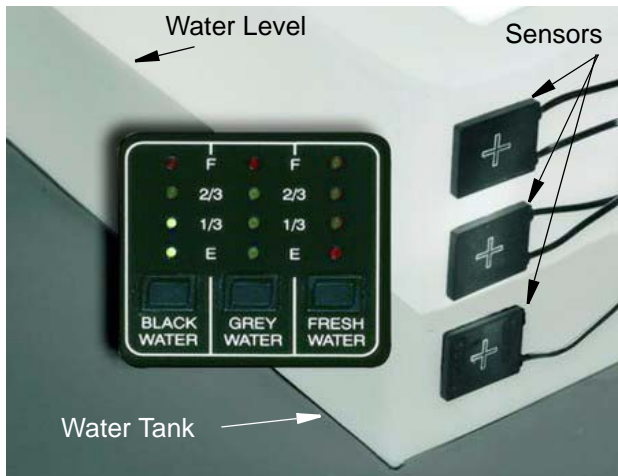

For example, if the fluid level is 1-2" below the FULL sensor, the monitor will show the level to be only 2/3 even though the tank is nearly full.

If a tank is about 1/4 full, the monitor will register an empty tank because the fluid level is below the 1/3 sensor even though there is still fluid in the tank.

However, when the indicator reads FULL, the tank is actually full.

**Tank Capacities**

See "Tank Capacities" in Introduction section.

**Propane Gas Level**

Press and Hold the "Levels Test" switch to show approximate propane tank level.

The propane level is registered by a sending unit on the tank. The gauge mounted on the side of the tank will give a more accurate indication of actual tank level if needed.

**Battery Charge Meter**

Press and Hold the "Levels Test" switch to check the level of charge (voltage) in the 12-volt house battery.

The colored segments (red, yellow and green) will light from the bottom up to the amount of charge the battery contains.

- Green - good or adequate charge.
- Yellow - marginal charge.
- Red - battery needs charging before use.

To get an accurate reading;

1. Both the chassis engine and the generator engine must be shut off and 120 Volt AC shoreline unplugged.
2. An interior light should be turned on to provide a small load which draws off the battery surface charge.

**Water Pump Switch**

When use of the self-contained water system is desired, turn the "Water Pump" switch on. The "Pump On" light will illuminate when the pump switch is on and the system is operable. Water will be available as soon as a faucet is opened. Refer to "Water Pump" for additional information on the water pump and initial start-up.



*(Some models may also have a pump switch in the water system compartment on the outside of the coach.)*



### WATER HEATER – GAS

Read the Water Heater Operating Guide in your InfoCase for complete safety warnings, operating instructions and maintenance information before operating the water heater.

**Be sure the water heater is filled with water before starting either electric or propane operation.**

To fill the water heater, turn the Water Pump switch on and open a hot water faucet anywhere in the coach. When water begins to flow steadily from the faucet, the water heater is full.

#### Propane Gas Operation

- Press the Water Heater switch on the Monitor Panel.



- The “Pilot Out” light will glow for about 10-15 seconds, then it will go out. The “Heater On” indicator will remain lit.
- If the “Pilot Out” light comes on during propane operation, it means that the burner has gone into “lockout” mode and must be restarted. If this happens, turn the Water Heater switch off for about 5 minutes, then turn it back on.

### WATER HEATER - GAS/ ELECTRIC

#### –If Equipped

#### (with Motor Aid water heating system)

The gas/electric water heater has a dual power feature. It can operate from propane gas or 120-volt house current; or it can use both at the same time for quicker recovery at times when you are using a lot of hot water.

*Read the Water Heater Operation Manual for complete Safety Warnings, Operating Instructions and Maintenance Information before operating the water heater.*

**Be sure the water heater is filled with water before starting either electric or propane gas operation.** To fill the water heater, turn the Water Pump switch on and open a hot water faucet anywhere in the coach. When water begins to flow steadily from the faucet, the water heater is full.

#### For Propane Gas Operation

Press the Water Heater switch on the Monitor Panel. The “Pilot Out” light will glow for about 10-15 seconds, then it will go out. The “Heater On” indicator will remain lit. If the “Pilot Out” light comes on during gas operation, it means that the burner has gone into “lockout” mode and must be restarted. If this happens, turn the Water Heater switch off for about 5 minutes, then turn it back on.

See the water heater user’s guide in your InfoCase for further information.



Gas Water Heater Switch on systems monitor panel

### **For Electric Operation**

Turn on the Water Heater electric element switch. The shoreline must be connected or generator running for electric operation.



Electric Water Heater Switch typically located near systems monitor panel

### **For Quick Recovery Operation (Dual Heating)**

Turn On both Water Heater switches; the gas one on the monitor panel and the electric one. This will help reheat the water heater tank more quickly than a single source would alone. Use this mode when you are using a larger than normal volume of hot water.

### **Operating Instructions**

Read the operating and safety information provided in the Water Heater Operation Manual in your InfoCase.

## **MOTOR AID WATER HEATER -If Equipped**

The motor aid uses heat from the chassis engine cooling system to heat water in the water heater while driving. Hoses are routed from the engine to a heat exchanger surrounding the water heater tank.

Under normal conditions, the entire contents of the water heater can be heated in about two hours or 100 miles of driving. This means you can have hot water at the faucets immediately upon arriving at a site.

The motor aid also increases the capacity of the engine cooling system, allowing the engine to run cooler under many conditions.



### **CAUTION**

Any leak in the heat exchanger or its supply or return lines could cause loss of coolant and subsequent engine failure. We recommend that you periodically inspect these connecting lines and the heater to insure that no leaks have developed.

## **PRESSURE-TEMPERATURE RELIEF VALVE**

On occasion, water may be seen seeping from the water heater pressure temperature relief valve. This is no cause for repair or replacement of the valve.



Water Heater Exterior Service Access

Normally there is an air gap at the top of the water heater tank which acts as a pressure buffer. In time, however, heated water may expand and fill this air gap, causing a slight increase in water pressure. This may cause the P-T valve to “weep” until the air gap is manually replaced.

 **CAUTION**

Operate this valve only when the water heater and engine cooling system are cold!

### To Replace the Air Gap:

1. Turn off the water heater switch and incoming water supply (city water and/or demand pump).
2. Open a faucet in the motor home to relieve water pressure.
3. Pull the handle of the P-T valve straight out and allow water to flow until it stops.



Lift handle straight out to open P-T valve when water heater is cold \*

4. Let the handle of the P-T valve snap shut.
5. Close the faucet and turn on the water supply before switching the water heater on.

Manually operate the pressure temperature relief valve at least once a year.

*\*If your water heater is equipped with the Motor Aid system, it uses an extension from the engine cooling system to heat water in the water heater while driving. The engine cooling system must also be cold before opening the pressure-temperature relief valve. See “Motor Aid Water Heater” for more information.*

---



---

## PROPANE GAS FURNACE

### To Start Up:

1. Open the LP gas tank valve by turning fully counterclockwise



Thermostat Switch  
• Move to Heat or Gas position for furnace operation

Temp Selector  
• Press up or down to select temperature

2. Move THERMOSTAT switch from Off to Heat and press the Temp Selector button (Up/Down arrows) until the desired temperature is shown in the display.
3. Furnace fan should start to blow immediately after setting the thermostat.
4. After about 30 seconds, the furnace burner should light.
5. The furnace should now cycle off and on automatically as the thermostat demands just like a household furnace.

*NOTE: If heat does not come out of the heat ducts after a minute or so the burner is not lit.  
Turn thermostat off for 3-5 minutes, check to be sure propane gas tank valve is open and tank is not empty, then try steps 2-4 again.  
If the furnace will not light after three attempts, go to Shut Down steps and contact your dealer or a local RV service center for repair.*

### **To Shut Down:**

1. Slide thermostat switch to Off position.
2. Close propane tank valve if coach will be stored for a period of time.

### **For Further Information**

Please see the furnace operating instructions provided in your InfoCase for further information, including operating precautions, and periodic maintenance. See the Coach Maintenance Schedule for recommended intervals.

*NOTE: If the furnace burner has any residuals of metal protectant or lubricants used during manufacture of the furnace, it may smoke slightly when the furnace is used for the first time and may set off your smoke alarm.  
We recommend that you provide adequate ventilation when using the furnace for the first time to avoid a*

*nuisance smoke alarm.  
We do not recommend removing the smoke alarm battery.*

---

---

## **HEAT PUMP -If Equipped**

Your coach may be equipped with an air source heat pump built into the air conditioning system. Because the heat pump operates on electricity, it provides economical heat inside your coach and helps reduce the use of propane gas for heating in cooler weather.

A heat pump can be thought of as an air conditioner running in reverse. An air conditioner absorbs heat from the air on the inside of the coach and moves it to the outside. The heat pump does exactly the opposite. Even cold air contains some heat, so a heat pump will extract heat from the outside air on a cold day and carry it to the inside of the coach to maintain a comfortable temperature.

The efficiency of a heat pump decreases as the outdoor air temperature drops, so supplementary heat is often needed when the outside temperature nears freezing. This system is set to automatically start the gas furnace to assist the heat pump if room temperature cools to 5 degrees or more below the thermostat set temperature. You may wish to manually switch to furnace heat to maintain a higher temperature when outside temperatures begin to reduce the efficiency of the heat pump. The heat pump will not operate when the outside temperature falls below 36 degrees F.

### **To operate the heat pump:**

See the air conditioning/heat pump manufacturer's information in your InfoCase for complete operating instructions.



- Gas Heat = Gas Furnace
- Electric Heat = Heat Pump
- Cool = Roof Air Conditioner

### Check your Air Filter

Closed or blocked vents and a dirty air filter can hinder the efficiency of a heat pump.

- Be sure ceiling vents are open to distribute heat pump output air.
- The A/C return air filter should be checked monthly for dirt build-up and cleaned or replaced as needed. See “Air Conditioner Filter” elsewhere in this section.

---

### DUCTED ROOF AIR CONDITIONING SYSTEM

The furnace thermostat also controls ducted roof air conditioner operation when the thermostat switch is placed in ‘cool’ position.

All cooling functions controlling to setpoint have a short cycle protection time delay of 3 minutes. There will be no delay if the cycle OFF time exceeds 3 minutes.

*NOTE: The ducted roof air conditioning system has ceiling registers that can be closed if necessary to force more cool air toward a specific area of the coach or to route cool air away from a specific area. If too many vents are closed, however, it can cause the air conditioner unit to shut down, particularly in high humidity conditions.*

### Further Information

Refer to the air conditioner manufacturer’s information in your InfoCase for complete operating instructions.

---

### AIR CONDITIONER FILTER

The washable foam filter should be checked monthly for dirt build-up and cleaned or replaced as needed.

It is located in the ceiling mounted return A/C grille in the lounge area.

**FURNACE-A/C THERMOSTAT OPERATION CHART**

The following chart shows the system functions with the “Heat/Cool” thermostat. Disregard references to heat functions when using the “Cool Only” thermostat in the rear bedroom.

■ Switch position    —■— Switch position does not matter or is inactive for this feature

FAN MODE SWITCH		THERMOSTAT SWITCH				FAN SPEED SWITCH		WHAT HAPPENS
Auto	On	Cool	Off	Gas*	Elec*	Lo	Hi	
			■					If the Thermostat Switch is Off, the whole heating and cooling system is off— nothing is happening.
<b>Gas Furnace Heating:</b>								
—■—	—■—			■		—■—	—■—	Furnace Blower runs along with the LP Gas Furnace which turns on and off as needed according to thermostat setting.
<b>Heat Pump Heating:*</b>								
■					■	—■—	—■—	A/C Fan runs at Low Speed along with the Heat Pump which turns on and off as needed according to thermostat setting.
	■				■	—■—	—■—	A/C Fan runs continuously at Low Speed while the Heat Pump turns on and off as needed according to thermostat setting.
<b>A/C Cooling:</b>								
■		■				■		A/C Fan runs at Low Speed along with the Air Conditioner which turns on and off as needed according to thermostat setting.
■		■					■	A/C Fan runs at High Speed along with the Air Conditioner which turns on and off as needed according to thermostat setting.
	■	■				■		A/C Fan runs continuously at Low Speed while the Air Conditioner turns on and off according to thermostat setting.
	■	■					■	A/C Fan runs continuously at High Speed while the Air Conditioner turns on and off according to thermostat setting.

**\*Note:** These instructions include the optional heat pump, which may not be equipped on your model. If you do not have a heat pump, the Thermostat Switch Gas position is the same as the Heat position on your thermostat— in this case, ignore the Elec Heat switch settings which apply to the heat pump only.

## SECTION 5 - PROPANE GAS

---

---

---

### PROPANE GAS SUPPLY

The propane gas system supplies fuel for the gas range/oven, water heater, furnace and refrigerator (while in gas mode). When used and handled properly, this system is safe and economical and provides modern living conveniences wherever you travel.

### How Propane Gas Works

Propane is a type of LP (Liquefied Petroleum) gas compressed into liquid form for easy transportation and storage. Propane gas may also be called tank gas, bottle gas, or simply LP.

Propane is used by appliances in vapor form only, but is stored in the tank as a liquid under very high pressure. As the liquid gas is released, it reverts back to a vapor and expands to many times its compressed volume.

### Propane Tank System

The storage reservoir for the propane gas system is a horizontally mounted tank which is permanently attached to the vehicle frame. The tank is accessible only from the outside of the vehicle.



### Refilling Propane Tank

Since the propane tank is permanently mounted to the frame, the motor home must be taken to a propane dealership for filling. Do not attempt to remove the propane tank from the vehicle. The tank is equipped with a fill adapter with both internal and external threads which allows easy filling with any propane filling equipment. The tank is full when liquid propane gas appears at the overflow valve.

*NOTE: The propane tank is equipped with an automatic 80% stop-fill device.*

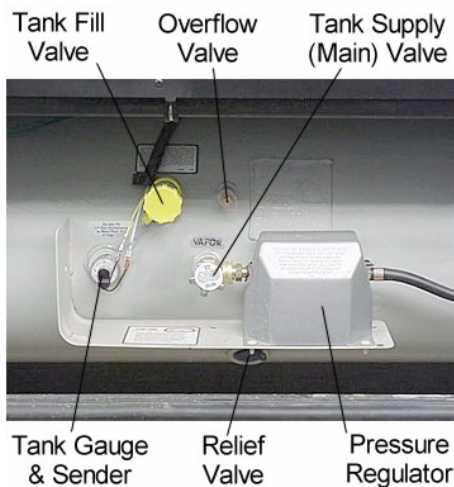

Propane Tank Features (Typical)

 **DANGER**

DO NOT FILL CONTAINER TO MORE THAN 80 PERCENT OF CAPACITY. FAILURE TO COMPLY COULD RESULT IN A FIRE OR PERSONAL INJURY.

Make sure the motor home is level when filling. It is possible to accidentally overfill the tank if the vehicle is not level, with the fill valve on the uphill side. Overfilling the propane gas tank can result in uncontrolled gas flow, which can cause fire or explosion. A properly filled container will contain approximately 80 percent of its volume as liquid propane gas.

**All pilot lights must be extinguished** and appliances and their ignitors turned off, and supply valve closed before refilling propane gas tanks or vehicle fuel tanks.

**Do not smoke or expose an open flame** while near a propane refueling area. Propane gas is heavier-than-air and extremely flammable.

**Never** fill the propane tank with engine or generator running.

Before opening the supply valve, check to be sure all controls for gas appliances are in the "Off" or "Pilot Off" position. If this step is not performed, propane gas could accumulate inside the motor home creating a fire or explosion hazard.

**Never use an open flame** to test for propane gas leaks.

Replace all protective covers and caps on propane system before filling.

## Selecting propane Fuel Types

We recommend using straight propane in your propane tank. Propane gas is commonly available at all propane gas outlets in the U.S. (According to the National propane Gas Association, propane gas outlets in the United States do not offer any other type of liquefied petroleum gas than propane to the general public.) Check local

phone directory yellow pages for locations of local propane gas refilling stations or bulk dealerships.

*NOTE: If you travel outside the U.S. with your motor home, you may find butane or propane/butane mixtures available in addition to propane. Because gas-burning RV appliances are designed to run on propane only, we recommend that you request straight propane only. Butane burns about 30 percent hotter than propane and can overheat some appliances, particularly refrigerators, and cause permanent damage. Other appliances designed to operate on propane can become sooted and lose efficiency by using butane fuel.*

## Air in the Propane Gas Tank

If your gas appliances do not stay lit or require frequent adjustment, even though you know the propane tank contains sufficient fuel, the problem may be air in the propane gas tank. Air in the tank mixes with the propane gas vapors causing them to burn poorly. This condition could linger for weeks if the air is not purged from the tank. Most propane gas dealers have equipment for purging air from propane gas tanks and will purge before refilling the tank.

---

---

## SAFE USE OF THE PROPANE GAS SYSTEM

The propane system is designed and built with strict adherence to federal, state and recreational vehicle industry requirements for mobile propane gas equipment.

For your safety, there are many safety devices and backup systems installed, such as tank fill overflow valves, an interior propane gas detector/ alarm, and an interior carbon monoxide (CO) detector/alarm.

Propane gas also contains an odor additive that you can smell if propane is present in the air.

Here are a few precautions to observe that will help you to use the propane gas system safely:



- Exercise caution at all times. Be familiar with the distinctive odor of propane gas. If a leak is suspected, turn off the supply valve immediately. Have the propane gas system checked by your dealer or other qualified propane gas service center.
- Do not tamper with the propane gas piping system, pressure regulator or gas appliances. Service and maintenance of propane gas system components should be performed only by your dealer or a qualified propane gas service center.
- Never attempt to connect natural gas to the propane gas system.
- Have the entire propane gas system inspected for possible leaks and missing or damaged parts at each tank filling. Also inspect before and after each trip, and any time trouble is suspected.
- Turn the propane supply valve off when not using the propane gas system.
- Never use a wrench to tighten the tank supply valve. It is designed to close leak-tight by hand. If a wrench is required to completely close the valve, it is defective and must be replaced.
- Be sure appliance and outside vents are open and free from obstruction when using the propane gas system.
- Never attach a lock or any device requiring a key to the propane tank compartment door. According to standards set for recreation vehicles, the propane supply valve must be readily accessible in an emergency.
- Exercise caution when drilling holes or attaching objects to the walls. Gas lines and electrical wiring could be seriously damaged and present an extreme safety hazard.

### PROPANE GAS WARNINGS AND PRECAUTIONS

It is illegal for vehicles equipped with propane tanks to travel on certain roadways or through certain tunnels in the U.S. To avoid inconvenience, check state regulations concerning flammable gas transportation.

#### Propane Gas Leaks

The following label is located in the vehicle near the range area. If you smell gas within the vehicle, quickly and carefully perform the procedures listed.

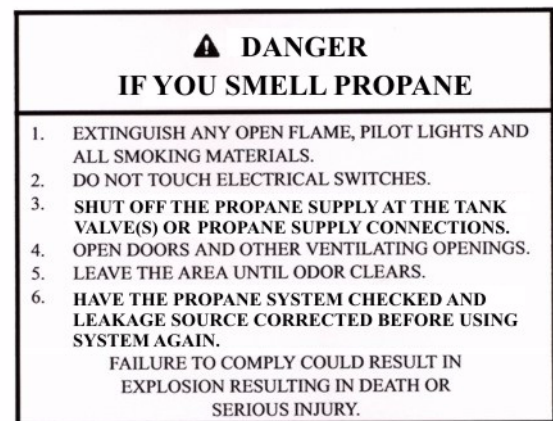

- All pilot lights must be extinguished and appliances and their ignitors turned off while refilling the fuel tank or propane tank.
- Never smoke while refilling vehicle fuel tank or propane gas tank.
- Avoid inhaling exhaust gases produced by burned gasoline, diesel fuel or propane gas in items such as the range, chassis engine, generator engine, refrigerator, furnace and water heater. They contain carbon monoxide, which is an odorless, colorless and poisonous gas.
- Do not bring or store propane gas containers, gasoline or other flammable liquids inside the vehicle because a fire or explosion may result. Propane gas containers are equipped with safety valves which relieve excessive pressure by discharging gas to the atmosphere.

**⚠ WARNING**

Propane cylinders shall not be placed or stored inside the vehicle. Propane cylinders are equipped with safety devices that relieve pressure by discharging propane to the atmosphere.

**FAILURE TO COMPLY COULD RESULT IN DEATH OR SERIOUS INJURY**

- Never use an open flame to test for propane gas leaks. Replace all protective covers and caps on propane system after filling. Make sure valve is closed and door latched securely.
- Portable fuel-burning equipment, including wood and charcoal grills and stoves, shall not be used inside the recreational vehicle. The use of this equipment inside the recreational vehicle may cause fires or asphyxiation.
- Regulators are equipped with a protective cover. Make sure that the regulator vent faces downward and that the cover is kept in place to minimize vent blockage which could result in excessive gas pressure causing fire or explosion.

*NOTE: If your model is equipped with a propane powered electrical generator, there will be two regulators stacked one upon another. One regulates the house propane supply pressure; the other regulates pressure to the generator.*

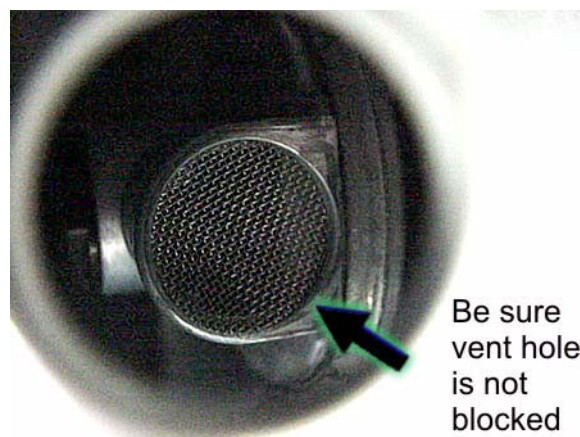

**PROPANE GAS PRESSURE  
REGULATOR**

The pressure regulator is protected from the elements by a plastic cover which should be left in place at all times. Only your dealer or a qualified propane gas service should remove the regulator cover for adjustments.

**⚠ WARNING**

Visually inspect the pressure regulator vent periodically for blockage by accumulated debris or insect nests, etc. Vent obstruction could result in excessive pressure which could cause a fire or explosion.

If any obstruction is apparent, have the regulator serviced by your dealer or a qualified propane gas service center.

**Regulator Freeze-up**

Regulator freeze-ups are caused by the presence of moisture in fuel. This moisture will pass through the cylinder valve and into the regulator where it can freeze. Fuel producers,

tank and bottle manufacturers and propane gas dealers take every precaution to reduce moisture, but sometimes only a fraction of an ounce entering the tank can cause problems. To help avoid the possibility of freeze-up, always keep tank control valve closed when not in use, even when tank is empty, to prevent moisture from collecting on the inside.

If regulator freeze-up should occur, you may attempt to thaw the regulator using a light bulb. **DO NOT USE AN OPEN FLAME OR HEAT LAMP.**

If moisture begins to cause problems, have your propane gas dealer inject a small amount of dry methyl alcohol in your tank (approximately one ounce to 20 pounds or one pint to 100 gallons) to help guard against regulator freeze-ups.

---

---

## PROPANE VAPORIZATION IN COLD WEATHER

Propane gas vaporization increases and decreases in direct relation to ambient temperature. In other words, the lower the temperature, the slower the liquid propane will vaporize into a usable gas for appliances.

This means that in extremely cold weather when a large volume of gas is being used by the furnace for heating, it is possible to experience a loss of gas pressure.

At first, this problem may appear to be caused by an empty tank or a regulator freeze-up, but is actually caused by failure of the liquid gas to vaporize as fast as it is needed by the furnace.

The demand for propane to produce heat increases to the point where the gas cannot vaporize fast enough to keep the furnace going. The only solution to this problem is to reduce gas usage where possible.

Adjusting the temperature on the gas/electric refrigerator may be a first step. Using less hot water will also help, as well as refraining from using the gas cooktop. A final step is to lower the thermostat setting to reduce gas usage by the furnace.



## SECTION 6 - ELECTRICAL

---

Your coach is equipped with an electrical system consisting of two separate voltages:

- 12-volt DC system (battery current) and
- 120-volt AC system (household current)

The 12-volt system consists of two internal power sources, while the 120-volt system is operated from an outside power source or the optional 120-volt generator.

---

---

### ELECTRICAL CAUTIONS

- Careless handling of electrical components can be fatal. Never touch or use electrical components or appliances while feet are bare, while hands are wet, or while standing in water or on wet ground.
- Improper grounding of the vehicle can cause personal injury. Do not plug the utility power cord into an outlet which is not grounded and do not adapt the plug to connect to a receptacle for which it is not designed.
- Do not attach an extension cord to the utility power cord.
- Be sure that all electrical appliances to be used contain 3-prong plugs for proper grounding.
- Avoid overloading electrical circuits. Replace fuses or circuit breakers with those of the same size and amperage rating only. Never use a higher rated fuse or breaker.
- Use caution when handling or working near electrical storage batteries. Always remove jewelry and wear protective clothing and eye covering. Avoid creating sparks.

---

---

### 120-VOLT AC SYSTEM

The 120-volt system operates from the shoreline cord connected to an outside 120-volt utility service such as those at campgrounds, or from the 120-volt generator. When the shoreline cord is connected to an outside power source, or when the auxiliary electric generator is running, the power converter automatically changes a

portion of the 120-volt current to 12-volt DC current. All equipment in the motor home that is normally powered by the house batteries is then powered through the converter.

In addition, the following equipment is entirely dependent on 120-volt current: air conditioner, refrigerator (when placed in AC mode), microwave oven, and any 120-volt electrical equipment used at convenience outlets.

---

---

### EXTERNAL POWER CORD (Shoreline)

The external power cord (commonly referred to as a “shoreline”) is located in a compartment on the left (driver’s) side of the coach.

 <b>WARNING</b>
Do not connect the external power cord to any receptacle until you have contacted the owner and/or attendant of the premises to verify proper polarity and grounding. It is the responsibility of the owner of the electrical receptacle to ensure that the receptacle is properly wired and grounded. Reverse polarity and improper grounding of the vehicle can cause personal injury or death.

The three-prong power cord is designed to ground the electrical system through the receptacle. It is also designed to carry the amperage output of most campground outlets. If the electrical receptacle to be used is designed to mate with the three prongs on the power cord plug, the electrical connection can be expected to carry rated load.

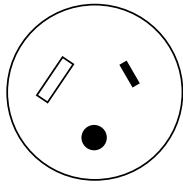

30 Amp Receptacle



## WARNING

Do not plug the power cord into an outlet which is not grounded, or adapt the plug to connect to a receptacle for which it is not designed.

Be sure that all three prongs of the supply cord are properly plugged into the receptacle.

Do not connect the power cord to an extension cord.

### Connecting the Power Cord

To connect to an external power source, remove the power cord from the utility compartment and plug it into a suitable power receptacle.

A flip-down hatch lets you route the power cord out the bottom of the compartment so you can close the compartment door while the power cord is connected.



1. Flip the hatch downward.



2. Swivel the cover section aside to reveal cord notch.



3. Route the cord through the notch and flip the hatch back up into place and close the compartment door.

*NOTE: Always keep service access passage closed while utility connection is not in use.*

### Park Fuses or Breakers

Most campgrounds are equipped with a fuse or circuit breaker at the receptacle. This protects the park's wiring, as well as the power cord on your vehicle, from electrical damage. If electrical power fails, contact the park attendants and have them check the fuse or breaker for your supply receptacle.

After disconnecting the power cord, neatly replace it in the utility compartment.

### POWER CENTER (Converter)

The power converter is generally located in a lower cabinet face in the galley or living area depending on the floorplan of your model.

The converter power panel contains the house electrical system 120-volt circuit breakers and 12-volt fuses.

The power converter changes 120-volt AC current from the auxiliary generator or the shoreline into 12-volt DC current for use by 12-volt equipment in the motor home.

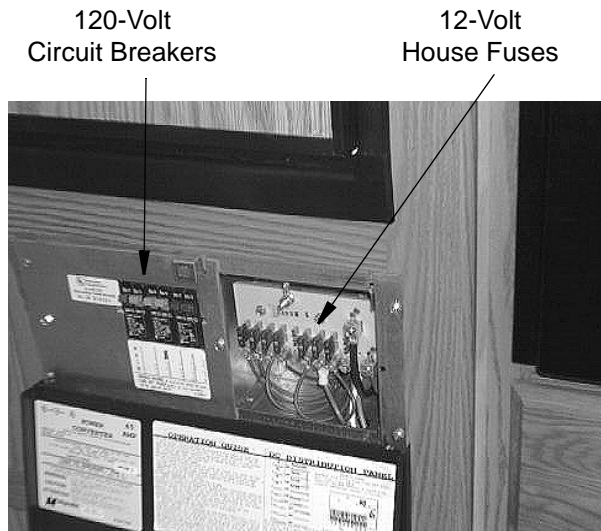

Power Center (Converter)

Certain circuits, however, remain unchanged for use by items which require 120-volt current, such as the air conditioner(s), the refrigerator in AC mode, the microwave oven, etc.

*NOTE: The converter will not change 12-volt DC current to 120-volt AC.*

Current drawn from the house batteries passes through the power converter unchanged, although it is routed through a series of protective fuses located on the power panel.

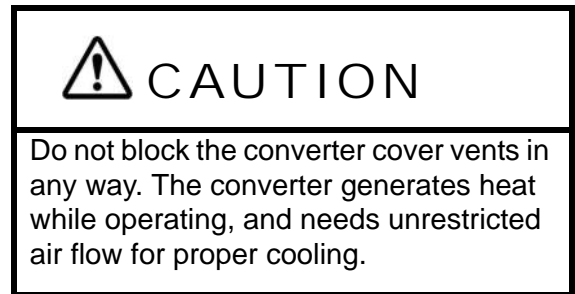

### Further Information

See the manufacturer's operation, care and maintenance information in your InfoCase.

### Charging Section

The converter charges house batteries while 120-volt external power is connected. The converter will automatically "sense" the condition of the battery. If it is below "full charge", the Charging Section will start charging the batteries.

If the house batteries have been extremely discharged, they will accept charge at a relatively high amperage rate. If they are only slightly discharged, they will charge at a lower amperage rate. The rate of charge will decrease as the batteries reach "full charge", then will continue "trickle" charging at a very low amperage rate. If your battery does not charge as described above, it is possible the battery is defective.

### Thermal Overload

A thermal overload will "break" the 120-volt AC power to the converter section of the Power Center if the power converter becomes overheated. This can result from operating above its maximum limit for an extended period of time or by obstruction of ventilation to unit.

*NOTE: The power converter section will automatically route 12-volt lights and motors to house battery power in this event.*

The thermal overload will reset itself after a period of time, and the lights and motors will again resume operation from the power converter section. If the breaker trips again shortly after reset, take immediate steps to correct the cause of

overheating. A portion of the house 12-volt load (lights or motors or both) should be turned off to reduce total load. Also, inspect the power converter to make sure ventilation is not obstructed.

---

---

## 120-VOLT CIRCUIT BREAKERS

The breaker panel protects all 120-volt components in the motor home from either an overload on the circuit or a short in the wiring or component itself. When an overload or short develops, the breaker will open preventing damage to the system.

Shut off the equipment (example: roof air conditioner) and allow a brief cooling period. Then reset the breaker by moving the switch to “Off” and back to “On”. If the breaker is continually tripped and no overload is evident, have the system checked for a short in the wiring or the appliances.

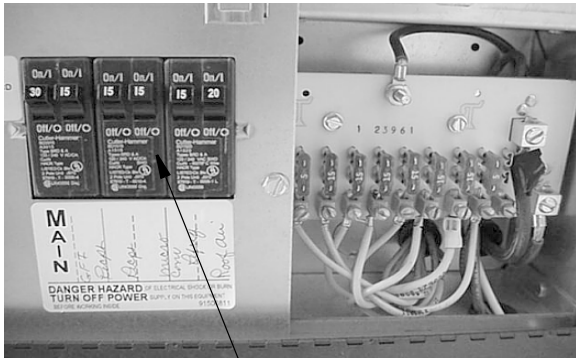

120-Volt Circuit Breakers

*\*Typical view of breaker panel. Breaker arrangement may vary according to appliance and equipment options. Fuses and breakers are labeled on panel.*

---

---

## 120-VOLT RECEPTACLES (OUTLETS)

A number of standard household electrical outlets are provided throughout the coach for connecting small appliances such as televisions, radios, toasters, etc.

An exterior outlet is also located on the outside of the coach near the entrance door or in a storage compartment on the passenger side of the coach.

---

---

## GROUND FAULT CIRCUIT INTERRUPTER

Bath, galley and exterior outlets are connected to a GFCI (Ground Fault Circuit Interrupter), which is an extremely sensitive circuit breaker that will help to protect against severe electrical shock if a ground fault develops. If such a condition occurs, the GFCI will break the circuit by turning off the power to the protected outlets. Should this occur, unplug all the appliances on that circuit and press the reset button on the GFCI equipped outlet.

If the GFCI keeps tripping, have the electrical system checked and repaired, if necessary, before using again.



Push to Reset circuit after monthly testing or ground fault tripping.

Push to Test at least monthly. Should break circuit. Press Reset button to reconnect.

GFCI Outlet  
(Ground Fault Protector)



**! WARNING**

The GFCI will not completely eliminate the risk of electrical shock. Small children and persons with heart conditions or other disabilities which make them especially sensitive to electrical shock may still be injured by a 120-volt receptacles even though protected by a Ground Fault Circuit Interrupter.

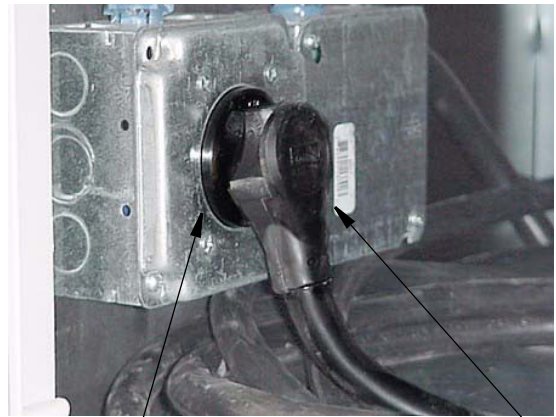

Generator Receptacle

Power Cord

**ELECTRICAL GENERATOR  
-If Equipped**

**! WARNING**

Careless handling of the generator and electrical components can be fatal. Never touch electrical leads or appliances when your hands are wet, or when standing in water or on wet ground. Do not attempt to repair the generator yourself. Service should be performed by an authorized service center. Do not plug the power cord into the generator receptacle while the generator is running.

To use the 120-volt generator, plug the power cord into the generator receptacle within the utility compartment before starting the generator.

**Generator Operation**

See the manufacturer’s operation, care and maintenance in your InfoCase.

**Generator Hourmeter**

This meter is located on the monitor panel. It registers the total number of hours that the generator has been operated.

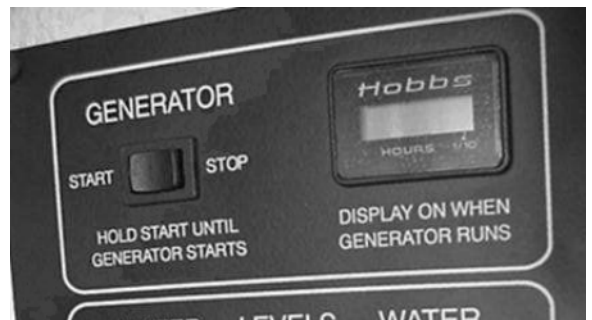

Refer to the hourmeter to determine when periodic maintenance is due and to record services which have been performed.

## Operation Warnings and Cautions



### WARNING

The exhaust of all internal combustion engines contains carbon monoxide (CO). This poisonous gas is colorless, odorless, tasteless, and lighter than air. The exhaust systems of both your motor home engine and your generator engine have been installed with your safety in mind. However, certain precautions must be taken when using them to protect yourself from conditions beyond the control of the manufacturer.

1. Do not simultaneously operate the generator engine and a ventilator which could draw exhaust gases into the vehicle.
2. Do not open windows or ventilators on the end or side of the vehicle where exhaust pipe of the generator is located.
3. Park the vehicle so that the wind will carry the exhaust away from the vehicle. Also, note the position of other vehicles to be sure their exhaust will not enter your vehicle.
4. Do not operate the generator engine while parked if vegetation, snow, buildings, vehicles, or any other object can deflect the exhaust under or into the vehicle.

Check auxiliary generator oil level frequently during periods of use.

Refer to the generator manufacturer's maintenance information in your InfoCase for specific recommendations.



### WARNING

Never check generator oil level while generator engine is running.

---

---

## 12-VOLT DC SYSTEM

The DC voltage system consists of the chassis battery, the 12-volt house batteries, and the 12-volt power converter.

### Converter

See "Power Center."

### Chassis Battery

The chassis battery is used to operate the engine starter and automotive accessories and controls found on the instrument panel. The slideout room systems and the electric step are also connected to the chassis battery.

See your chassis manual for further information on chassis batteries and chassis electrical system.

### House Batteries

The house batteries supply power to 12-volt equipment located in the living area of the motor home. This includes interior lights, range exhaust fan, furnace fan, water pump, water level and holding tank gauges, 120-volt generator starting, refrigerator and bath roof vent fan.

The house batteries may also be used to start the engine if the chassis battery is discharged. (See "Battery Boost Switch" or "Aux Start Switch.")

House batteries are "deep-cycle" type batteries specially designed for recreational vehicle use. They will provide longer lasting power than standard automotive batteries, and will withstand the frequent drain-and-recharge cycles that occur under the demanding conditions of a camping outing.

The house batteries are automatically charged by the chassis alternator while the engine is running.

### AUXILIARY BATTERY DISCONNECT SWITCH (AUX. BATT)

The AUX BATT disconnect switch lets you disconnect the house batteries from the 12-volt system of your coach during storage periods to avoid battery drain by electrical items that are hooked directly to the house batteries, such as clock displays and radio memories, etc.

Always leave this switch ON while using the coach.

*NOTE: Some electronic displays and memory functions may need to be reset after power has been reconnected.*

See also “Battery Care” elsewhere in this section.



Aux. Batt. Switch - typical  
(Near entrance door)

### HOUSE BATTERY ACCESS

The house batteries are located in a compartment beneath the interior entrance steps.

Unfasten the step retainer, then lift the step upward and remove to service batteries.

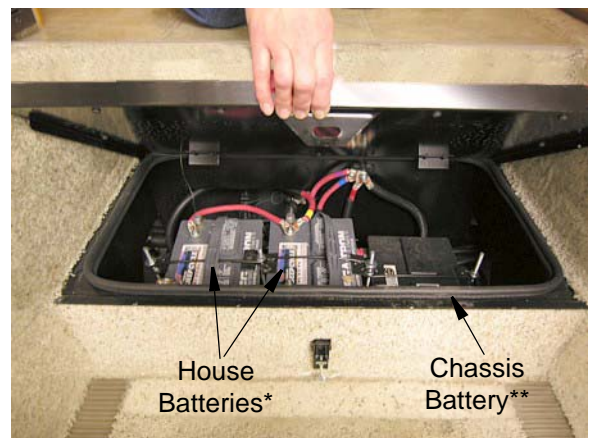

\*Some models may have only one house battery  
\*\*Class-C models located in engine compartment



### BATTERY CARE

Lead -acid type batteries are electro-chemical devices for storing and releasing electrical charge. As such, they are simply an electrical reservoir, not an electrical source. As soon as energy is removed from the battery, it should be replaced by the engine alternator or the RV converter system.

If a battery sits unused for 30 days or more, especially during warm weather, it can develop a deposit of sulfate crystals on the metal plates inside the battery. This condition is called

'sulfating' and prevents the battery from either releasing or accepting a charge. If this condition occurs, the battery must be replaced.

If a battery does not contain at least 80% charge during freezing temperatures, the electrolyte can freeze and crack the battery case.

### The two best defenses against sulfating and insufficient charge are to:

1. Turn off the Auxiliary Battery Disconnect (Aux Batt) switch to avoid parasitic discharge (the trickle discharge caused by directly connected components like propane gas detectors or digital clock displays, etc.)
2. Check the battery and recharge as necessary at least once a month during long storage periods. Turn the Aux Batt Switch off to avoid electrical arcing when attaching or detaching charger clamps.

### WARNING

**California Proposition 65 Warning:** Battery posts, terminals and related accessories contain lead and lead compounds, chemicals known to the state of California to cause cancer and reproductive harm. Wash hands after handling.

*NOTE: We do not recommend leaving the shoreline plugged in continuously during storage periods because the batteries can lose electrolytic fluids and become damaged from continuous charging without periodic use or maintenance. We recommend following regular battery inspection and maintenance, especially in cold weather.*

### Further precautions are:

- Remove the battery from the coach.
- Store it in a cool place on a wooden or rubber pad to inhibit conductive transfer.
- Check the state of charge periodically to avoid discharge or sulfating.

To ensure that the battery will always accept and hold a charge, follow these simple maintenance practices.

- Make sure the batteries always remain securely clamped in the battery tray.
- Make sure battery cable clamps are tight on the terminal posts and are free of corrosion.
- Neutralize corrosion buildup or acid film on top of battery by washing with a baking soda/water solution. Rinse with clear water.

*NOTE: Make sure vent caps are on securely to prevent baking soda solution from entering the battery and contaminating the electrolyte fluid.*

### WARNING

Before removing any battery cables or battery, make sure all 12-volt equipment in the motor home is off and the power cord has been disconnected. Be sure to replace the battery terminal boot back onto the positive terminal after servicing. Care must be taken to avoid pinching the cable between any metal parts. Should the cable be damaged, a short circuit could result in personal injury or damage to equipment. Replace any damaged cables at once. Always remove jewelry and wear protective clothing and eye covering when checking or handling batteries.

- Clean and tighten battery terminals and have the specific gravity checked at least once a year.
- Check the battery fluid level every month, or more often in hot weather. Fill to approximately 3/8 inch above the plates. DO NOT OVERFILL. If fluid is added during freezing weather, the motor home should be driven several miles to mix water and electrolyte to prevent freezing.
- Fluid level check may be omitted if equipped with maintenance-free batteries.

### WARNING

To prevent wiring damage, it is essential when replacing the cables on the battery, or when using a “booster” battery, that the positive post and the positive cable be attached and the negative post and negative cable be attached. The posts are marked (+) plus and (-) minus. If a “boost charger” is used while battery is in the motor home, disconnect both battery cables before connecting the charger to avoid damage to engine electronic components. Never attempt to charge or boost a frozen battery.

### 12-VOLT HOUSE FUSES AND CIRCUIT BREAKERS

All 12-volt circuits and equipment in the coach area of the motor home are protected by either a fuse panel or breaker panel. When a circuit is overloaded or a short develops in any part of the system, a fuse or breaker will shut down that circuit. If this happens, turn off all affected lights or appliances and reset the breaker or replace the fuse with a new one of equal amperage rating.



Chassis/House 12V Circuit Breakers behind cover panel in floor compartment between front seats.

A label on the panel states the amperage rating and circuit protected for each fuse or breaker.

### Fuse Panel

The fuse panel is mounted on the right-hand side of the power converter.

110-Volt Circuit Breakers      12-Volt House Fuses

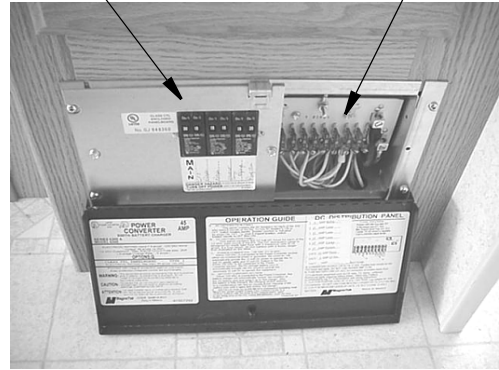

Power Converter

The fuse panel accepts only blade type plug-in fuses. Always replace fuses with those of the same amperage rating.

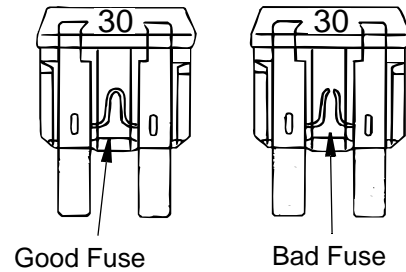

Good Fuse

Bad Fuse



## SECTION 7 - PLUMBING

---

---

### FRESH WATER SYSTEM

The fresh water system provides water to the galley sink, shower, bathroom lavatory, toilet and water heater. Water may be supplied by either of two sources:

- a fresh water tank and water pump located within the motor home, or
- any external fresh water source to which the motor home may be connected, known as “city water.”

### Filling the Fresh Water Tank

Always fill the fresh water tank at an approved potable water filling facility or a known purified drinking water source.

The tank is filled through the city water connection (Fresh Water Inlet) inside the water service center.

The Fresh Water Valve routes the water from the city water hose to the fresh water tank for filling.

1. Attach hose to the Fresh Water inlet.



Fresh (City) Water Connection

2. Turn the Fresh Water Valve to Tank Fill position



Fresh Water Valve in Tank Fill position  
(located in water service center)

3. Turn city water supply on.
4. Tank is full when water flows from tank vent tube beneath coach.
5. Turn off city water supply and disconnect from city water connector.
6. Turn Fresh Water Valve to Normal position to use the water pump. *The Tank Fill position is only for pressure filling the water tank from the city water hose connection.*



Fresh Water Valve in Normal use position  
(located in water service center)

### Using City Water

When connected to an outside source of water, the water bypasses the demand pump and storage tank and supplies pressure directly to individual faucets and toilet. A check valve built into the pump prevents water from entering the pump and filling the storage tank.

1. Connect hose to city water connection as described in previous steps.

2. Turn Fresh Water Valve to Normal position and turn the water pump switches OFF.



Fresh Water Valve in Normal use position  
(located in water service center)

*NOTE: Always keep the tank fill valve in Normal position unless you are filling the tank. If this valve is left in the Tank Fill position while using the city water, water will keep flowing into the tank and out the tank vent tube onto the ground and the water pump will run without delivering water to faucets.*

### Disconnecting from City Water:

1. Turn the city water source off.
2. Open a faucet on the coach (such as the exterior wash station if equipped) to relieve line pressure.
3. Disconnect the city water hose from the coach and replace the cap on the fresh water inlet.

*NOTE: Be sure the Fresh Water Valve is in Normal position to use the water pump. If the valve is in Tank Fill position, the pump will run continuously without delivering water.*

### Pressure Regulators

Because city water pressure varies from location to location, we recommend obtaining an in-line water pressure regulator to prevent damage to any components, connections and seals in your fresh water system.

We recommend a regulator that controls water pressure to **40 psi. max.**

These devices simply connect in-line between the supply hose and the city water input on the coach.

Water pressure regulators are commonly available at any well stocked RV dealership and many large retail discount or home supply centers.

---

---

## WATER PUMP

When your coach is not connected to a city water supply, water is supplied from the fresh water tank by a water system demand pump. A demand pump is designed to run only when you are using water. When you open a faucet, the water line pressure drops and the pump begins to run, and it will continue to run as long as the faucet is open. When you close the faucet, the line pressure backs up to the pump, and it shuts itself off.

The pump is self-priming and will run briefly to build up line pressure when the Water Pump Switch is first turned on. See “Initial Water Line Priming” for instructions on using the water system for the first time.

### Further Information

See the water pump manufacturer’s operation, care and maintenance information in your InfoCase.

### Pump Strainer

The pump is equipped with a cleanable strainer to capture any possible tank borne particles that could damage pump components.

*NOTE: We recommend that you check and clean the strainer after each tankful of water during the first few uses of the water pump system. Thereafter, remember to check it at least yearly, and be sure to empty water from it during winterization procedures.*



Unscrew bowl and remove to clean strainer



Water Pump Strainer  
in Water Service Center (typical)

### To Clean Pump Strainer

- Be sure all water pump switches are OFF.
- Twist the inlet cap (bowl) counterclockwise to unscrew from the strainer assembly.
- Remove the bowl and pull the strainer screen out of the bowl to tap out any particles and rinse clean.
- Insert the strainer screen back into the bowl, then screw the bowl back onto the strainer assembly.

*NOTE: You must also empty the strainer when winterizing your coach to avoid water freezing and cracking the filter bowl.*

### Water Pump Switch

The water pump switch is located on the systems monitor panel. (Some models may have an additional switch in the water service center.)

While the switch is “ON”, the pump will automatically supply water as it is needed.

We recommend that you turn the water pump switch off whenever you will be away from the vehicle or not using the water system. In time, a slow leak in a faucet could drain the water tank, fill the holding tank and discharge the house batteries.

### Initial Water Line Priming

1. Make sure that all water drain valves are closed, including water heater valve.
2. Turn water pump switch to “OFF” position.
3. Fill water tank.
4. Open all faucets, hot and cold.
5. Turn on pump switch.
6. Close each faucet as it begins to deliver a steady stream of water (close cold water first). Leave hot water faucets on until they also deliver a steady stream of water. This will ensure that the water heater is filled with water.
7. Check to be sure pump stops soon after all faucets have been closed.
8. Pump is now ready for automatic operation. Pump will start when a faucet is opened and stop when the faucet is closed.

---



---

### DISINFECTING YOUR FRESH WATER SYSTEM

To assure complete disinfection of the potable water system, it is recommended that the following procedure be followed on a new system, one that has not been used for a period of time, or one that could have become contaminated.

This procedure is also recommended before long periods of storage such as over winter.

### Models with City Water Tank Fill

The fresh water tank must be filled through the city water connection in the water center.



These models require temporarily connecting an external cartridge type water filter assembly in-line between the city water hose and the city water fill to add disinfecting solution to the tank. These filters are commonly available at RV supply stores.

1. Remove the filter cartridge and pour 1/2 cup of household bleach (sodium hypochlorite solution) for each 30 gallons of tank capacity into the empty filter canister and screw the canister back onto the filter base.

This solution will result in a residual chlorine concentration of approximately 50 ppm in the water system. *(If a 100 ppm concentration is required as discussed in step 3, use 1 cup of household bleach for each 30 gallons of tank capacity.)*

The bleach will be drawn into the tank when the city water is turned on and the Fresh Water Valve is turned to Tank Fill position.



**NOTE: Alternate Method** – If you do not have an in-line cartridge filter, bleach can be added using your water hose. This method has the additional benefit of disinfecting the city water hose at the same time.

-Connect the water hose to the city fill connection on your coach. Do not connect to city water faucet yet.

-Use a funnel to pour the required amount of bleach into the open end of the hose. Hold the hose up to allow enough room for the bleach to flow into the hose.

-Connect the hose to the city water faucet and turn on so the water will force the bleach into the tank and continue filling the tank with water.

2. Fill the tank completely, then open each faucet in the coach and run the water until a distinct odor of chlorine can be detected in the water discharged. Do not forget the hot water faucets.
3. Let the system stand at least 4 hours when disinfecting with 50 ppm residual chlorine. *(If a shorter time period is desired, then a 100 ppm chlorine concentration should be allowed to stand in the system for at least 1 hour.)*
4. Drain the fresh water tank.
5. Install the filter cartridge into the filter canister, then refill the tank with fresh water.
6. Open each faucet again and run fresh water to flush chlorinated water from the lines. Run the water until there is no odor of chlorine detected in the water discharged. Do not forget the hot water faucets. (It may take some time to flush the water heater with clean water.)
7. Water system disinfection procedure is done.



### WARNING

Chlorine is poisonous. Recap bottle and clean all utensils after use.

### Continuous Tank Disinfection (Superchlorination)

Some RVers like to ensure continuous sanitation of their fresh water tank by 'superchlorination' – maintaining an effective low level of chlorine in the tank at all times. The chlorine is then removed from drinking water by the Filtered Water Faucet.

Add 1 teaspoon of chlorine bleach (sodium hypochlorite) to your tank for each 10 gallons of tank capacity. When you fill the tank, this will result in a 6.7 ppm level of chlorine, which should kill harmful bacteria and slime-forming organisms.

Super chlorination does not affect city water usage– only the water tank.

### SHOWER HOSE VACUUM BREAKER

After using the shower, you may notice water dripping from the shower faucet assembly. The dripping results when vacuum in the shower hose (after closing the shower faucet) slowly releases and allows water remaining in the hose to drain down. This is a normal function of the shower valve assembly and is not a leak or defect.

	<h2>CAUTION</h2>
<p>If items are placed into the shower tub before shower valve vacuum release is complete, they may become wet.</p>	

### EXTERIOR SHOWER / WASH STATION

#### -If Equipped

The exterior wash station feature allows you to do things such as rinse off sand or salt after a swim, rinse off muddy boots, or bathe your pet outside the coach. Some models may have a water pump switch located near the shower faucet for convenience.



Exterior Shower/Wash Station  
(Typical)

### TOILET

The toilet in your motor home is very similar to the household type, except that it is designed to use only a small amount of water per flush. It uses a high velocity jet of water producing a swirl effect to efficiently cleanse the bowl.

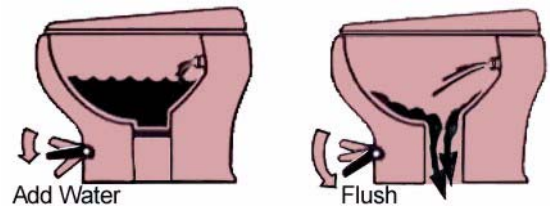

#### Important “Don’ts”

- Don't use facial tissue or regular toilet tissue in the RV toilet. These will not disintegrate sufficiently and will often cling to the sides of the holding tank. Toilet tissue made specifically for use in RV toilets and holding tanks is available at most RV supply centers.
- Don't dispose of sanitary napkins or other non-dissolving items in the toilet.
- Don't put automotive antifreeze or caustic chemicals, such as laundry bleach or heavy detergents into the toilet or holding tank. These products may damage plastic or rubber parts in the system.

See winterizing instructions at the end of this section to prepare the toilet for storage in freezing conditions.

#### Further Information

See the toilet manufacturer's operation information in your InfoCase for complete operating, care, and maintenance information.

### WASTE WATER SYSTEM (Holding Tanks)

The drainage system is self-contained and uses two separate holding tanks to contain the waste water until it can be dumped at an appropriate waste water disposal site. This means you can use the toilet, sinks, and shower even in areas where utility hookups are not available.

The black water holding tank contains the sewage from the toilet and may include bathroom lavatory on some models. The gray water holding tank contains the waste water from the galley sink and shower, and may include bathroom lavatory.

See “Specifications” in the Introduction section for tank capacities for your model.

### Dumping Holding Tanks

1. Remove drain hose from water service center.
2. Remove dust cap from drain and connect sewer hose. Be sure it is firmly attached.

*NOTE: The dump valve drain outlet swivels downward when necessary to avoid bends in the drain hose which could trap solids while dumping or to provide more direct drainage while using on-site sewer hookups.*

3. Place the outlet end of sewer hose into disposal opening.



Holding Tank Dump Valves (Typical)

*Note: Black and Gray tank valve positions may be reversed depending on floorplan and tank location.*

*The center outlet section may be swiveled downward for better hose alignment and drainage.*

4. Open the black water valve (black handle) with a quick pull and make sure there are no sags in the hose. Move the hose gently about to dislodge any waste and ensure complete drainage. Close black water valve as soon as tank is empty.

*NOTE: DO NOT OPEN BOTH VALVES AT ONCE. Do not open the gray tank valve until the black tank is drained and dump valve closed to avoid sewage back-up into gray tank. Gray water also rinses any black water solids from the drain hose.*

5. Open the gray water valve (gray handle). Be sure there are no sags in the hose to ensure complete drainage. Close gray water valve as soon as tank is empty.
6. Add an odor control chemical to the sewage holding tank through the toilet. These chemicals are available at most RV stores.
7. Rinse sewer hose thoroughly with water and stow.

*NOTE: We recommend that you dump all holding tanks before traveling to avoid carrying unnecessary weight.*

### Using On-Site Sewer Hookups

The drain hose may remain attached to the dump outlet and be routed out the bottom of the compartment while the motor home is parked and connected to an on-site sewage hookup.

*The center outlet section may be swiveled downward for better hose alignment and drainage.*

*NOTE: Always keep service access passage closed while utility connection is not in use.*

When using a sewer hookup, keep the dump valves closed until a tank becomes full or when preparing to leave the site. This keeps the solids in suspension, allowing them to be carried out with the liquids when the dump valve is opened. If the valve is left open, the liquids will drain off, leaving solids in the tank. Should this accidentally happen, disconnect the hose, fill the tank about half full with water, and drive a few miles to dislodge the solids. A few starts and stops will aid in the process. Then reconnect the hose and drain in the normal manner.

## Holding Tank Level Indicators

See “Systems Monitor Panel” in the Appliances section for further information on the monitor panel and checking tank levels.

See “Specifications” in the Introduction section for tank capacities for your model.

---



---

## HOLDING TANK HEATER

### –If Equipped

Your coach may be optionally equipped with black water and gray water holding tank heaters to allow use of waste utilities in freezing temperatures. The holding tank heater power switch is located near the monitor panel. The illuminated switch will glow when the power is on.



DO NOT operate the holding tank heater unless you are providing a supplemental 12-volt power source to recharge the house batteries. This means either the shoreline cord must be plugged into a 120-volt source, or the auxiliary generator must be operating, or the chassis engine must be running (such as when driving down the road). This will prevent excessive discharge of the house battery.

*NOTE: The holding tank heater pads are electrical resistance type heating elements. This type of heating element typically uses a large amount of current while operating. If the tank heaters are used without a recharging source, they will drain the house batteries in a relatively short period. Typically the batteries would not support overnight heating without a supplemental charging source.*

---

## WATER LINE AND TANK DRAIN VALVES

The water drain valves are used to drain water from the water tank and the water supply lines when preparing the motor home for storage or when sanitizing the water system.

To open or close the drain valves, turn the handles in the directions indicated by the following illustration.

Drain valve locations are listed on the following pages.

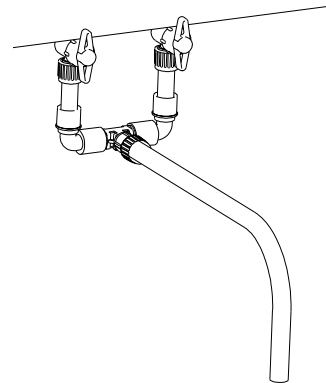

Water Line Drain Valves

**NOTE:** This water line drain valve is NOT used with the exterior shower option. With the exterior shower option, water lines run through the showerhead.



Water Tank  
Drain Valve  
(Typical)



**CAUTION**

Leave bypass valve handle in **NORMAL FLOW** position if draining water and blowing out water lines. Place in **BYPASS** position **ONLY** when using antifreeze solution in water lines.

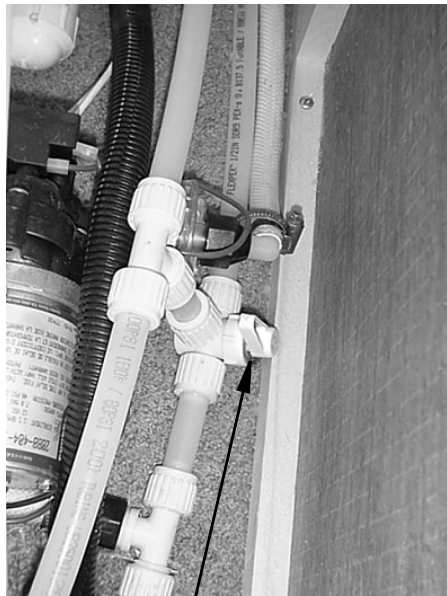

Water Heater By-Pass Valve (Typical)

**WATER HEATER BYPASS  
WINTERIZATION VALVE**

Your coach may be equipped with a water heater bypass valve for easier winterization of water lines using RV antifreeze. See Water System Drain Valve Locations chart at the end of this section for valve location on your model.

Turn the handle as shown to either Bypass or Normal flow through the water heater.

**WINTERIZING PROCEDURES**

You can winterize the water and plumbing system of your coach using one of the following two methods – 1) Blow out waterlines using compressed air or – 2) Fill waterlines with RV water system antifreeze.

**Method 1 – Blow Out Procedure  
(Drain and purge waterlines using  
compressed air)**

1. **Level the Motor Home.** If the coach is not level, there may be “low points” in waterlines that can trap water in the lines and prevent it from draining properly.
2. **Drain Fresh Water Tank and Waterlines.** Open all waterline drain valves and drain fresh water tank. (See “Water System Drain Valve Locations” chart at end of this section for locations of drain valves on your model.)
3. **Drain Exterior Shower/Wash Station.** Open exterior shower knobs and lay shower head on ground as shown to drain any water left in the shower line. Also place the tip of your finger into the city water inlet and gently

press the backflow valve “button” in the center of the inlet to drain any water trapped in the inlet line.



Using Exterior Shower to drain waterline  
(Typical View- appearance on your coach may differ)

4. **Remove the Water Filter Cartridge (if equipped).** Remove the filter cartridge from the filter assembly below the galley sink.  
*(If your coach is not equipped with a filtered water faucet, proceed to the next numbered step.)*



Water Filter Assembly  
(Located below galley sink)

\* Typical View - your coach may vary

- Twist the filter cartridge counter-clockwise (left) about a quarter-turn and pull it down and out of the filter socket.
5. **Remove Full-Coach Water Filter (if equipped).** Remove the filter canister from the full-coach water filtration system in the

water center compartment (if equipped) and discard the filter cartridge.

*(If your coach is not equipped with a full-coach water filtration system, proceed to the next numbered step.)*

After emptying the canister, remount it onto the filter assembly and continue the blow-out procedure.

6. **Open Faucets.** Turn on the water pump and open all sink faucets and shower head knobs. Leave open after water stops flowing.
7. **Drain Toilet.** Press the toilet flush pedal and hold until water stops flowing in the toilet. Then turn water pump switch off.
8. **Drain Optional Appliances.** At this time, if your coach is equipped with an optional refrigerator ice maker, dishwasher, or washer/dryer, the waterlines for these appliances must also be drained.  
*(See “Winterizing Optional Appliances” instructions at the end of this section.)*  
If not, proceed to the next step.
9. **Drain Water Heater.** Turn off the water heater power switch before draining the water heater tank to avoid damage to the heating element. Drain the water heater by removing the plug from the base of the water heater tank, accessible from the outside of the coach.  
*(Requires socket and ratchet.)*



Water Heater Drain Plug  
(Remove with socket)

Also open the Pressure-Temperature relief valve at the top right portion of the tank to prevent air locking in the tank while draining.

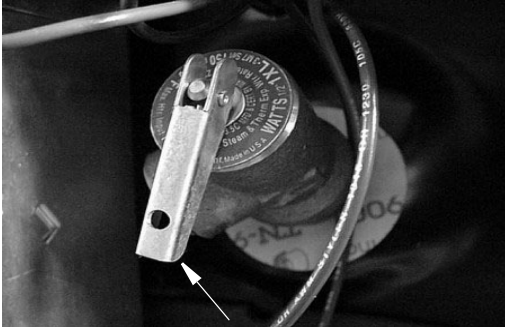

Lift handle only when water heater is cold

10. **Connect Air Pressure:** After water has stopped draining at all faucets and drain valves, leave faucets open and connect a “blow-out” plug to the city water connection on the coach. Then use a compressed air hose regulated to 30 psi or less to force air through the system. A blow-out plug can be purchased at any Winnebago® or Itasca® dealer.

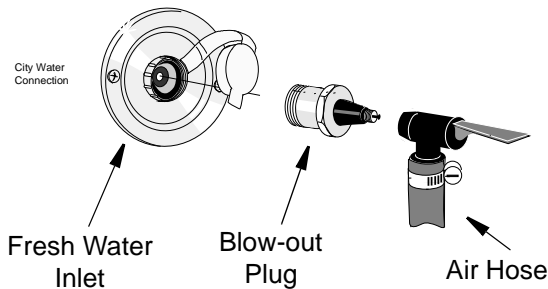

 <b>CAUTION</b>
Limit air pressure to 30 psi to avoid damage to pump or waterlines.

*NOTE: DO NOT burst air into the system. This can damage the water pump. It is better to let air in slowly.*

11. **Let air flow for five minutes** until water is completely drained out of faucets and drain valves. Then close faucets one at a time.
12. **Drain Toilet.** Operate and hold toilet flush lever until water is completely drained from toilet.

13. **Turn air pressure off.** Disconnect water purge adapters. Recap the city water inlet to avoid contamination by dirt or insects.

**After Disconnecting Air Pressure**

14. Empty the full-coach water filter canister of any water trapped during blow-out procedure. Remount empty canister onto filter assembly. *(If not equipped with a full-coach water filter system, continue to next step.)*
15. Close all waterline and tank drain valves and all faucets to avoid contamination by dirt, insects, or rodents.
16. Reinstall the Water Heater drain plug and close the P-T Relief Valve.
17. Pour about one cup of RV antifreeze down each drain for the galley sink, lavatory sink, and shower/tub. This fills the drain trap pipes to prevent holding tank odors from entering the coach during storage.

*NOTE: It is not necessary to add antifreeze to the toilet since the flush valve will be closed.*

*Do not add automotive antifreeze or caustic chemicals such as bleach or laundry detergents into the toilet bowl or holding tanks. Although these products may have a deodorizing effect, they may damage plastic and rubber parts in the system.*

18. Empty the water pump strainer filter bowl to avoid water freezing and cracking the filter bowl. See “Water Pump” previously in this section.

**Dump and Clean Holding Tanks**

19. Completely drain the sewage and waste water holding tanks at an approved waste disposal site. Drain the sewage tank first so the following waste water can rinse any waste solids from the dump outlet and sewer hose.
20. Flush the sewage tank using the Black Waste Tank Flush Inlet (if equipped).



21. Close dump valves and refit the dust cap onto the drain outlet.

This will inhibit rust formation on valve shafts and prevent entry and contamination by airborne debris, insects, and rodents.

***Your drainage and fresh water systems are now totally winterized.***

***See instructions for removal from storage in Maintenance Section.***

### Method 2 – Antifreeze Fill Procedure

**(Fill plumbing lines with RV water system antifreeze)**

*NOTE: As an alternative to totally draining the waterlines, you may winterize tanks and lines by filling them with non-toxic RV water system antifreeze through the plumbing system.*

*This product is available from your dealer and from most RV supply stores and national retail outlets.*

*Follow directions on the container to determine the correct amount to use for your coach.*

Your coach is equipped with a manually operated waterline winterization system for your convenience in winterizing fresh waterlines.

The system features a diverter valve with siphon tube to draw non-toxic RV water system antifreeze into the waterlines. There is also a water heater bypass valve to avoid filling the water heater with antifreeze. This feature is located near the water pump in the water center or utility compartment.

### CAUTION

Leave Bypass valve handle in “Normal Operation” position if draining water and blowing out waterlines. Place in “Bypass” position **ONLY** when using antifreeze solution in waterlines.



### WARNING

NEVER use automotive antifreeze/coolant in your RV water system. Auto antifreeze contains ethylene glycol which, if ingested, can cause blindness and can be fatal.

### Remove Water Filters (if equipped)

Before pumping RV antifreeze into water system, remove water filter cartridges (if equipped.)

1. Remove and discard the filter cartridge from the filtered water faucet assembly (if equipped) below the galley sink. *(If your coach is not equipped with a filtered water faucet, proceed to the next numbered step.)*



Water Filter Assembly below Galley Sink  
(Located below galley sink)

\* Typical View - your coach may vary

- Twist the filter cartridge counter-clockwise (left) about a quarter-turn and pull it down and out of the filter socket.

*NOTE: The water filter head has a built-in bypass. No separate diverter plug is needed.*

2. Remove the filter canister from the full-coach water filtration system in the water center compartment (if equipped) and discard the filter cartridge.

(If your coach is not equipped with a full-coach water filtration system, proceed to the next numbered step.)

After removing filter, remount the empty canister onto the filter assembly and continue the antifreeze fill procedure.

### Set Up Winterization Valves

3. Turn Winterization Valve 1 to “Water Heater Bypass” position to avoid filling water heater with antifreeze.



See Water System Drain Valve chart at the end of this section for location on your coach

4. Place handle of Winterization Valve 2 in the “Winterize” position.



See Water System Drain Valve chart at the end of this section for location on your coach

5. Remove and save the protective cap from the end of the antifreeze siphon tube (which connects to Winterization Valve 2). Insert the end of the siphon tube into a pail or other container with 2 to 3 gallons of non-toxic RV antifreeze solution.

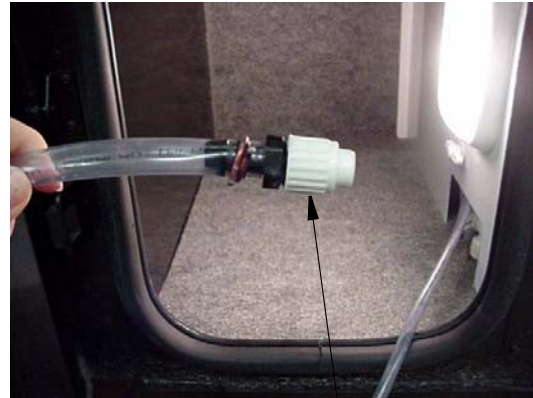

RV Antifreeze Siphon Tube  
(Located in water center or near water pump)  
- Insert into container of RV water system antifreeze

### Fill Lines

6. Turn the water pump switch on.
7. Open each hot and cold water faucet handle/knob in the coach – one at a time each in turn until antifreeze solution just begins to flow from the faucet, then close.  
Do not forget exterior shower/wash station knobs (if equipped.)
8. Press the toilet flush pedal and hold until antifreeze begins flowing into the toilet. Leave small amount of antifreeze that remains in the bowl.

### When Done Adding RV Antifreeze

9. Turn water pump switch off.
10. Turn the Winterization Valve 2 to “Normal”. This will stop the flow from the antifreeze siphon tube and revert the tank line flow to the pump.
11. Replace the protective cap onto the end of the antifreeze siphon tube to keep out insects and debris when not in use.

### Drain Water Heater

12. Turn off the Water Heater power switch before draining the water heater tank to avoid damage to the heating element.
  - Drain the water heater by removing the plug from the base of the water heater tank, accessible from the outside of the coach. (Requires socket and ratchet.)

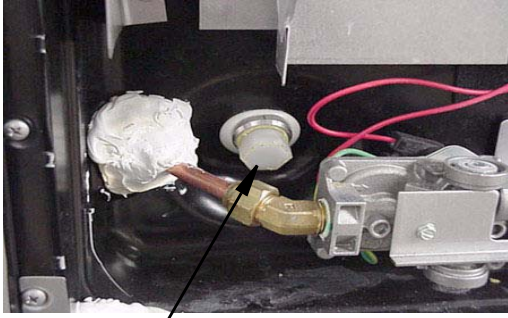

Water Heater Drain Plug  
(Remove with socket)

- Also open the Pressure-Temperature relief valve at the top right portion of the tank to prevent air locking in the tank while draining.



Lift handle only when water heater is cold

- Reinstall the water heater drain plug and close the P-T relief valve when drained.

### Drain Appliances

13. At this time, if your coach is equipped with an optional refrigerator ice maker, dishwasher, or washer/dryer, the waterlines for these appliances must also be drained. (See “Winterizing Optional Appliances” instructions at the end of this section.) If not equipped with optional appliances, proceed to the next step.

### Close All Drain Valves

14. Close all waterline drains and tank drain valves to avoid contamination by dirt, insects, or rodents.

15. Pour about one cup of RV antifreeze down each drain for the galley sink, lavatory sink, and shower/tub. This fills the drain trap pipes to prevent holding tank odors from entering the coach during storage.

### Dump and Clean Holding Tanks

16. Completely drain the sewage and waste water holding tanks at an approved waste disposal site. Drain the sewage tank first so the following waste water can rinse any waste solids from the dump outlet and sewer hose.
17. Flush the sewage tank using the Black Waste Tank Flush Inlet (if equipped).
18. Close dump valves and refit the dust cap onto the drain outlet.  
This will inhibit rust formation on valve shafts and prevent entry and contamination by airborne debris, insects, and rodents.

*Your drainage and fresh water systems are now totally winterized.*

*See instructions for removal from storage in Maintenance Section.*

WATER SYSTEM DRAIN VALVE LOCATIONS		
Model	System	Drain Valve Locations
23B	Water Lines	Open exterior shower faucet and lay shower head on ground.
	Water Tank	Large yellow-handled valve beneath couch or front dinette seat depending on floorplan option.
	Water Heater	Drain plug on outside of coach, behind service door. Use socket to remove drain plug. See photo on previous page.
	Water Heater Bypass Valve	On panel in water service compartment.
	Winterization (Antifreeze) Valve	On panel in water service compartment.
23H	Water Lines	Open exterior shower faucet and lay shower head on ground.
	Water Tank	Large yellow-handled valve beneath galley. Remove bottom drawer to access.
	Water Heater	Drain plug on outside of coach, behind service door. Use socket to remove drain plug. See photo on previous page.
	Water Heater Bypass Valve	Beneath removable access panel in floor of right rear exterior storage compartment.
	Winterization (Antifreeze) Valve	Beneath removable access panel in floor of right rear exterior storage compartment.
23J	Water Lines	Open exterior shower faucet and lay shower head on ground.
	Water Tank	Large yellow-handled valve behind a removable louvered access grille on the lower face of the wardrobe cabinet.
	Water Heater	Drain plug on outside of coach, behind service door. Use socket to remove drain plug.
	Water Heater Bypass Valve	In right rear exterior storage compartment.
	Winterization (Antifreeze) Valve	In right rear exterior storage compartment.

## SECTION 8 - ENTERTAINMENT

### TV – 12-VOLT LCD –If Equipped

The liquid crystal display flat panel TV is powered by 12-Volt DC current. The TV 12V Power Switch must be On to operate the TV.

The 12-volt current is supplied from the chassis or house batteries– or from the power converter when connected to shoreline power or running the generator.



12-Volt LCD TV - Models 23J & 23B\*  
\*Model 23B mounted above rear of dinette



TV/Radio Speaker  
Selector Switch

TV/DVD 12-Volt  
Power Switch

Models 23J & 23B  
(end of galley cabinet)

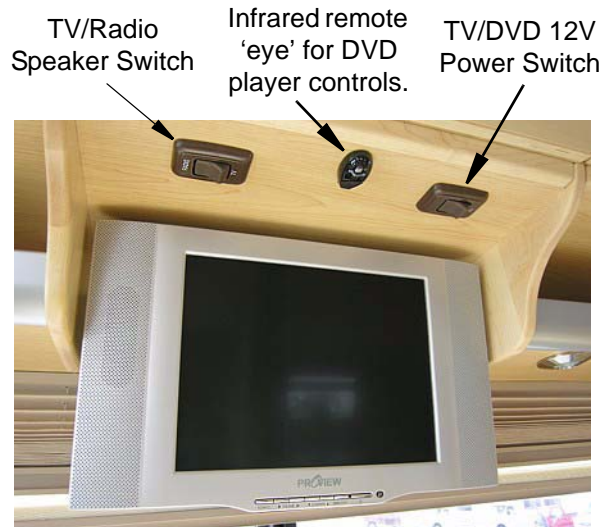

12-Volt LCD TV - Model 23H

The speaker selector switch must be in TV position to enable surround sound speakers while watching a DVD or TV. This switch is mounted on the end of the galley cabinet or underside of the DVD cabinet.

*NOTE: When the TV or DVD Player are not in use, the power switch should be turned off to eliminate drain on the 12-Volt house battery.*

### Further Information

See the television manufacturer's information in your InfoCase for operating instructions.

### AUDIO-VIDEO SYSTEM BASIC OPERATION

*NOTE: For your convenience, we have also included a handy, tear-out version of this "A/V System Basic Operation" guide in Section 8 of your Operator Manual Supplement. See your InfoCase for specific operating guides for audio and video components.*

---

---

**DVD PLAYER WITH DELUXE  
SOUND**

**-If Equipped**



Models 23J & 23B



Model 23H

The DVD player is connected to the TV and plays through the TV stereo speakers or the deluxe sound speakers in the lounge area of the coach.

**Provide 12V Power**

The TV and DVD player operate on 12-volt DC current.



Models 23J & 23B



- Turn on the 12-Volt master power (TV) switch, located on the cabinet wall near the DVD player or on the underside or inside of the video cabinet as shown.

*NOTE: When the TV or DVD Player are not in use, the power switch should be turned off to eliminate drain on the 12-Volt house battery.*

**Connect Deluxe Sound Speakers**

- Press the Speaker switch to TV position to connect speakers to TV and DVD. Speaker switch may be located on the underside of the video cabinet or on the end of the galley cabinet as described above.



**Set TV Video Input**

- Turn TV and DVD player On
- Press the SOURCE button on the TV or TV remote to select "INPUT 1."



- The TV screen will display the DVD player logo when the correct input is selected.



**Play DVD**

- Insert DVD into player. DVD will begin to 'load' automatically. TV screen will typically show "READING" or "LOADING."
- The DVD may load directly to the main title/menu screen or it may begin to play previews. You may be able to skip previews if desired by pressing the 'NEXT' button on the DVD remote until you see the main menu screen.

- When the main menu screen appears, use the arrow buttons on the DVD remote to select the desired entry or press the ENTER or PLAY buttons on the remote (or 'Play' button on DVD player) to begin playing the feature. Volume is adjusted with the DVD remote..



Models 23J & 23B

### TV SOUND THROUGH DELUXE SPEAKERS -If Equipped

When watching TV programs (broadcast, cable or satellite), the TV normally plays sound through its own built-in stereo speakers. If you wish to connect TV stereo sound output to the deluxe sound speakers for a richer sound quality, follow these steps:

- Press the Speaker switch to TV position to connect speakers to TV.
- Turn the TV On.
- Use the TV Menu button to set TV audio output to 'Variable Audio Output.' (See TV owner's manual for instructions.) This will route TV stereo sound output to the deluxe speakers.
- Select TV channels and adjust volume using the TV remote.

### DASH RADIO THROUGH DELUXE SOUND SPEAKERS -If Equipped

To Listen to the Dash Radio through the Deluxe Sound speakers:

- Press the Speaker selector switch to RADIO position to connect the dash radio to the deluxe sound speakers. Volume is adjusted by radio buttons or radio remote.

- When the Ignition switch (key) is Off the Radio Power switch on the dash must be in 'House' position.
- While driving, the Radio Power switch should be in 'Engine' position.



### TV ANTENNA

The TV antenna on your motor home can be easily raised, rotated a full 360° and lowered from inside the vehicle by simply turning a crank or directional handle. A built-in signal amplifier designed to strengthen signals, is controlled by a power switch built into the optional video selector panel or on a wall plate assembly.

See the antenna manufacturer's operation, care and maintenance information in your InfoCase.

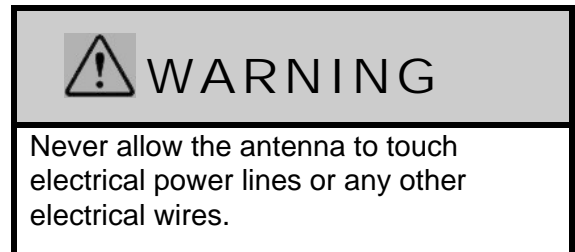

### Raising Antenna to Operating Position

Turn elevating crank clockwise in "UP" direction until some resistance to turning is noted (about 13 turns). Antenna is now in operating position.

Turn amplifier power switch "ON" to receive TV signal.



### Rotating Antenna for Best Picture

Make sure antenna is in the "UP" position. Pull down on directional handle using both hands until it disengages ceiling plate and rotate for best picture and sound on TV set.



**Lowering Antenna to Travel Position**

Rotate antenna until pointer on directional handle aligns with pointer on ceiling plate.

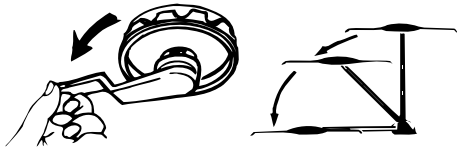

Turn elevating crank (counterclockwise) in “DOWN” direction until resistance is noted (about 13 turns). Antenna is now locked in travel position. Turn amplifier power switch “OFF”.

 <b>CAUTION</b>
Always align directional handle to “DOWN” position before lowering.
Never partially raise or lower antenna. Antenna must be raised fully up into operating position or lowered fully down into travel position.

---

---

**TV SIGNAL AMPLIFIER**

The TV signal amplifier is built into the antenna and can be turned on or off with a power switch inside the coach.

The amplifier power switch is located on a wall plate which may be mounted in various locations depending on floorplan. Some of these wall plates are not easily visible and may be in one of the following locations.

- Inside front overhead TV cabinet, if equipped.
- Inside or underside of a side overhead cabinet.
- In the optional entertainment center on the outside of the coach.

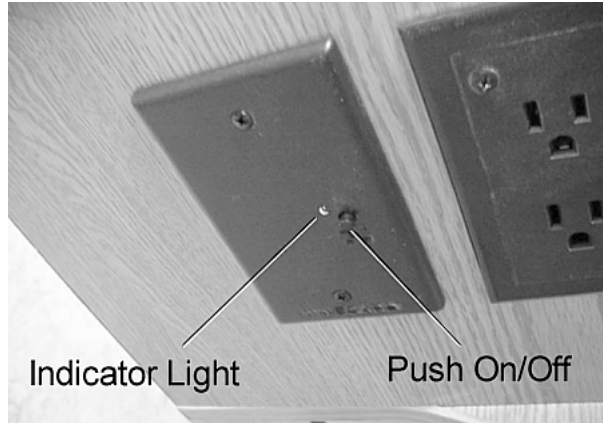

TV Signal Amplifier Power Switch  
*(Some models may also have a 12-volt outlet and/or coaxial jack on the wall plate.)*

An indicator light will glow when the switch is on and the signal amplifier is active.

**Checking Performance**

The TV signals available to an RV are entirely dependent on its location in relation to the transmitter. Signals may vary from strong to no usable signal at all. We recommend that the TV system be checked out in an area known to have good TV reception.

To check the antenna amplifier, raise the antenna, select a TV channel and rotate the antenna for best picture. Then turn off the amplifier power switch. If the antenna amplifier is working properly, the TV picture will now be degraded (snowy). When you turn the switch back on, the picture should again be sharp.

---

---

**CABLE TV HOOK-UP**

The cable television input connector is located in the utility compartment.





Cable TV Input Hook-Up in Utility Compartment

### TV SATELLITE SYSTEM WIRING

This coach is pre-wired for installation of a digital satellite system (DSS). Coaxial cable connections to hook up your satellite receiver are located in the right side overhead compartment. See your authorized Winnebago Industries dealer for proper installation and sealing of roof mounted components.



Satellite TV Receiver Connection  
(in front video center cabinet)



## SECTION 9 - FURNITURE & SOFTGOODS

### SLEEPING FACILITIES

#### **WARNING**

Do not use sleeping facilities while vehicle is moving.

#### **WARNING**

Do not exceed 225 lbs. maximum weight capacity. Misuse of ladder could result in death or serious injury. See Operators Manual before using ladder.

### FRONT BUNK

The front bunk is hinged at the front and fastened to the cab ceiling as shown when stored.

To use the bunk, unhook the fastener and lower into position.



A ladder for access to the bunk is stored in the right rear exterior compartment or beneath the slideout room couch.

### Before Using Bunk Ladder

- **Inspect the ladder** to make sure it is not damaged. Never use a damaged ladder.
- **Keep the rungs of the ladder clean and dry** while in use. Do not step onto the rungs if the rungs are wet, or if your shoes are wet or carry debris that could result in a loss of footing.
- **Never ignore warning labels** or weight limits defined on your ladder. The following warning label is located on or near the ladder:

- **Maximum Capacity: 225 lbs.**
- **Do not overload.** Ladder is intended for one person.
- **Make sure you are physically capable** to safely use the ladder. Strength, flexibility and stability are required.
- **Grasp the side rails firmly** and always use both hands as you climb the ladder. Keep your body centered between the side rails. Do not over-reach.
- **To protect children,** do not leave the ladder set up and unattended.
- **Always store** the ladder in a safe and dry location when not in use. Stow properly while in transit.
- **Do not store items** on the ladder. You could damage the ladder.

### To Use the Bunk Ladder

The top of the ladder can be hooked onto the brackets on the rear edge of the bunk as shown.



Attaching Bunk Ladder

- Lift ladder horizontally
- Slide C-shaped retainer ends onto brackets at rear edge of mattress.



- Lower ladder to floor.
- Make sure ladder is properly engaged onto retainer brackets and ladder is resting firmly on floor before using.



Front Overhead Bunk  
Shown with bunk lowered and ladder in position

---

## REAR BUNK –Model 23B only

The lower rear bunk is hinged so it can be folded up and latched against the backwall. This will provide room for storage of tall items such as bicycles through the right rear compartment door.

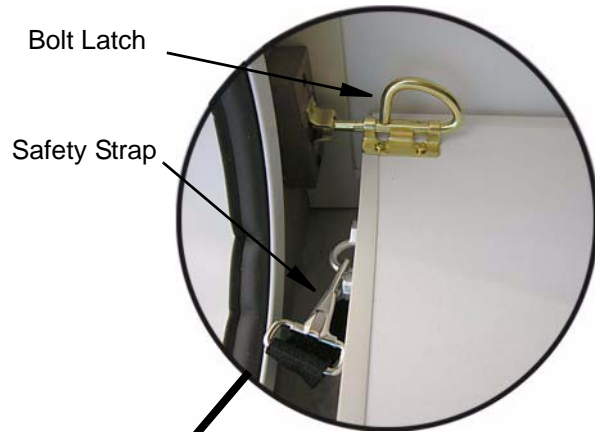

- Swing the bunk upward and secure with bolt latch at door end of bunk.
- Clip safety strap into loop for additional security against rough road conditions.

---

## COUCH/BED CONVERSION

### **Couch to Bed:**

Lift the front edge of the couch seat upward and pull outward from the wall while gently pushing downward on the backrest until the cushions lie flat. The bed is now ready for use.

### **Bed to Couch:**

Push the front edge of the seat toward the wall while lifting upward on the backrest until the couch is fully seated against the wall.

### DINETTE/BED CONVERSION -If Equipped (Typical view – your coach may vary)

#### Dinette to Bed:



1. Release the catch on the table leg brace and fold the leg up against the bottom of the table.



2. Remove the table from the wall support bracket by lifting the end of the table. Then lower the table to rest on the cleats attached to each dinette bench.



3. Arrange dinette cushions to cover bed area.



#### Bed to Dinette:

1. Reattach the table onto the wall support and lower the table leg.

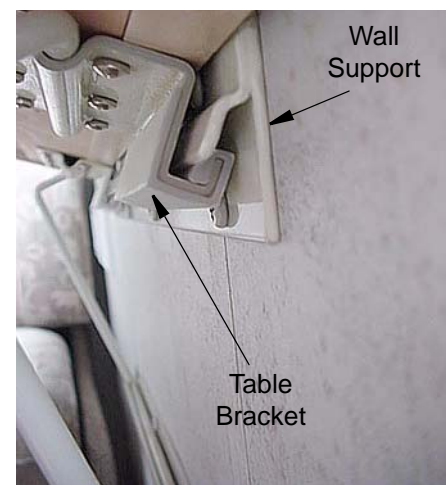

2. Make sure that the table leg is secured into the floor support bracket and the leg brace is locked.



---

---

## **DAY/NIGHTER PLEATED BLINDS**

### **-If Equipped**

Your coach may feature two-stage pleated window blinds that can be used for daytime or nighttime privacy.

### **Sun Filter**

The lower section is a translucent white shade that can be lowered for privacy without darkening the inside of the coach. It can also filter out harsh direct sunlight to help keep the inside of the coach cool in summer or to disperse light for houseplants.

### **Room Darkening/Privacy Shade**

The upper section is an opaque, darkening shade for nighttime privacy and daytime room darkening purposes. Pull both sections down together or separately.

See Maintenance & Storage section for adjustment and care instructions.

---

---

## **WOOD FURNITURE AND CABINETS**

### **-If Equipped**

People are drawn to the natural beauty of wood. At Winnebago Industries, our craftsmen work with the art found in each piece of wood to create cabinets of superior quality, backed by the Winnebago Industries warranty.

- Oak is a strong, open-grained hardwood that ranges in color from white to pink and reddish tones. Streaks of green, yellow and even black

may appear due to mineral deposits. Oak may also contain wormholes and wild, varying grain patterns. This distinct graining is considered a desirable quality and has made oak one of the most popular woods used for cabinetry.

- Maple is a close-grained hardwood that is predominately white to creamy-white in color, with occasional reddish-brown tones. While maple typically features uniform graining as compared to other wood species, characteristic markings may include fine brown lines, wavy or curly graining, bird's eye dots and mineral streaks. These traits are natural and serve to enhance maple's natural beauty.
- Cherry is characterized by its red undertones, but may vary in color from white to a deep, rich brown. Cherry is a close-grained wood with fairly uniform texture, revealing pin knots and curly graining. All wood will age with time and the finish will darken. This is especially true for cherry. This is a sought-after quality in cherry cabinetry, and those who select it expect this evolution.

No matter which species you choose for your new Winnebago Industries motorhome cabinetry, please keep in mind that no two pieces of wood are exactly the same.

Stains are likely to exaggerate the difference between open and closed grains and other markings in wood. Grain variation and color change should be expected. As hardwood ages, it will darken when exposed to different types of light. Color differences or changes in wood can also be caused by exposure to harsh chemicals, extreme heat or other contributing external conditions.

Any color change that occurs in both the finish and the wood is considered part of the natural aging process and is not to be considered defect or damage.

Additionally, wood species exhibit other defining characteristics, such as mineral deposits/streaks, knots, sap runs, pin holes and wormholes. These markings make the wood unique and contribute to its enduring beauty.

Therefore, since wood is a product of nature and will have certain natural characteristics and variances they are not covered under the warranty.





## SECTION 10 - SLIDEOUT ROOM

### SLIDEOUT ROOM OPERATION – ELECTRIC

Slideout rooms provide a spacious living area at the push of a button.

The main slideout control switch is located near the entrance door or Systems Monitor Panel.

If your model is equipped with a rear/bedroom slideout room, the switch will be located on a wall in or near the bedroom.



Slideout Switches (typical)

Your coach may have one or more of these switches depending on model, options and available equipment.

The slideout room system uses 12-Volt DC motorized mechanisms with an electronic control system to provide smooth operation and positive weather seal.

***NOTE: We recommend that you KEEP THE ENGINE RUNNING WHILE EXTENDING OR RETRACTING SLIDEOUT ROOMS so the engine alternator can provide maximum power for proper operation of the slideout mechanisms.***

### Travel Strap

The travel strap **must be released before extending the room** or damage to the coach will result.

The travel strap is designed only to help keep the room extension secured against the coach sidewall to maintain an effective weather seal while the vehicle is in motion. It is not designed

to withstand the force exerted by the room extension mechanism and will not prevent accidental extension of the room.

The travel strap is located near the floor at the front end of the slideout room.

### To Release:

- Pull the strap buckle outward and up to release tension on strap.
- Pull a short length of the excess strap back through the buckle to provide sufficient slack.
- Unhook the strap end peg from the mooring bracket on the floor and wall edge. Store strap in location of your choice. (Under the couch is one choice.)



### To Fasten Strap:

- Hook the strap end peg into the mooring bracket.

- Flip buckle downward and press toward strap until it “snaps” snugly into place against the strap.
- If a strap is loose or too tight after closing the buckle, release the buckle and pull the loose end of the strap in or out to adjust tension as needed. Then re-close the buckle.

 <b>WARNING</b>
Keep all persons clear of the slideout room and moving parts while extending or retracting. Do not occupy the slideout room while it is being extended or retracted.

### To Extend Slideout Room

#### Before Extending!

- Level the coach and set the Parking Brake.
- Release the safety travel straps inside the coach (front slideouts only).
- Make sure exterior compartment doors are closed so that they will not interfere with slideout operation.
- Make sure that there are no people who could be harmed or obstacles that could cause damage due to room extension.
- If the slideout room has a couch or other furniture, make sure no people or pets are seated on them until the room has been fully extended.

 <b>CAUTION</b>
Release slideout room travel straps before attempting to extend slide-out room. Fasten travel straps before driving vehicle.

#### Extend Procedure:

See “*Before Extending!*” before proceeding.

- Start the engine so the alternator can provide maximum power for proper operation of slideout mechanisms.
- Press the Slideout Room ‘EXTEND/OUT’ switch and hold until the room is fully extended– then release the switch.
- To stop extending the room during operation, release the button.

### To Retract Slideout Room

#### Before Retracting!

- Be sure the coach is level and the Parking Brake is set.
- Check the outside of the coach to make sure there are no people, pets or obstructions near the slideout room.
- Make sure that there are no people who could be harmed or obstacles that could cause damage due to room retraction.
- If the slideout room has a couch or other furniture, make sure no people or pets are seated on them until the room has been fully retracted.
- Remove all items from the coach living room floor, close cabinet doors and drawers. Be sure there are no items at the end of the bed or behind the driver seat or protruding from compartments which could be crushed or cause damage to floor covering or cabinets when the room is retracted.

 <b>CAUTION</b>
Although there is an awning over the roof of the slideout room, there is a possibility of debris getting onto the roof. Because the slideout roof is drawn into the interior of the coach when retracted, be sure there is no debris, such as excessive dirt, tree seeds, twigs, leaves, etc. on the roof before retracting.

### Retract Procedure:

See *“Before Retracting!”* before proceeding.

- Start the engine so the alternator can provide maximum power for proper operation of slideout mechanisms.
- Press the Slideout Room ‘RETRACT/IN’ switch and hold until the room is fully retracted– then release the switch.
- To stop retracting the room during operation, release the button.
- After the room has been retracted, refasten the safety travel straps.

---



---

### SLIDEOUT ROOM – EXTREME WEATHER PRECAUTION

Certain extreme weather conditions, such as heavy rains, heavy snow, and high winds – or any combination of these – could cause damage to the slideout room awning-cover (if equipped) or reduce effectiveness of the slideout room weather seals.

Also, freezing rain and snow can prevent the slideout awning-cover (if equipped) from closing and may cause damage to the awning-cover, slideout room, weather seals and mechanisms.

To avoid potential damage, we recommend retracting your slideout room(s) during extreme weather conditions.

---



---

### SLIDEOUT EMERGENCY RETRACTION

#### Crank-In Mode

If the room will not retract using the buttons and the mechanism is apparently malfunctioning, you may need to manually crank the room in to the travel position.

- Use a ratchet wrench and a 7/16” socket on the motor gearshaft to manually crank the room inward.
- The motor/gear assembly is located beneath the vehicle near the rear of the slideout room, just ahead of the driver side rear tires.

Use 7/16” socket on gear shaft to crank room in or out in event of power loss.

Pull motor brake lever out before cranking and push in when done cranking.

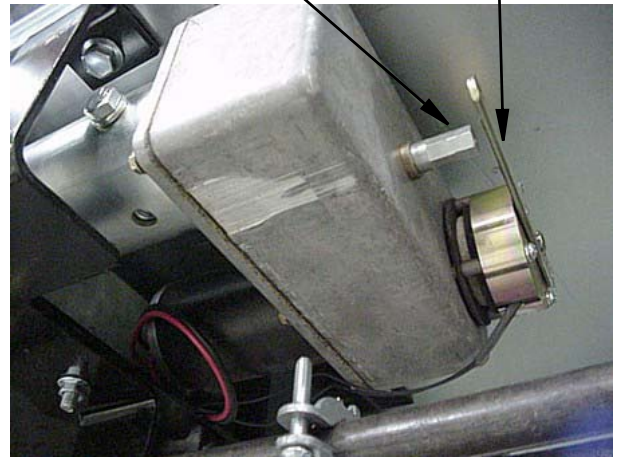

Slideout motor/gear assembly viewed from beneath coach

- Crank the room in until it is just ‘snugged up’. Do not over-crank or you could damage the gear assembly.
- Fasten the travel strap before driving the vehicle.
- See your dealer for service of the slideout mechanism before using again.

---



---

### GENERAL SLIDEOUT CARE

- Wipe outer seals occasionally with talc or 303 brand protectant for smooth quiet operation.
- Clean the floors inside before retracting the room to avoid vinyl flooring scratches or carpet pile snags.
- See your authorized dealer for regular maintenance and service of the slideout mechanism.



## SECTION 11 - MAINTENANCE & STORAGE

---

---

---

### SEALANTS

Water is a recreational vehicle's worst enemy when it is allowed to enter where it's not intended. Sealants perform a very important function and should be inspected closely and maintained regularly. Winnebago Industries utilizes many different types of sealants. Refer to the Recommended Sealant Application page at the end of this Section.

Sealants, in general, do not have "set" lifetimes. Varying environmental factors affect the pliability and adhesiveness of sealants. You or your dealer must:

- Inspect all sealants, a minimum of every six months.
- Inspect the moldings, windows, clearance lights, exterior compartment doors and all their attachments.
- Also, inspect weather seals around entrance door, etc., and if necessary have a dealer replace them immediately.
- Check for cracks, voids, gaps, breaks, adhesion, and any sign of physical deterioration.

*NOTE: Proper sealant inspection includes not just visual observation but running a finger along sealant seams to verify proper adhesion to the surface. Any loosened areas must be replaced.*

- Have the sealant replaced if you notice any of the above. Your local Winnebago Industries dealer has the correct and necessary parts and experience to help you maintain your sealants. See the Recommended Sealant Application page at the end of this Section.
- Always use the same type sealant that was removed.
- Immediately have dealership check moldings, windows and exterior attachments for leak source if you notice water inside of unit.



CAUTION

Sealants must be inspected every 6 months and replaced if necessary.

---

---

### ROOF

The roof is made of Thermo-Panel materials like the walls and floor. It will support the weight of an average adult should it become necessary to repair the roof or roof mounted components. It is not recommended, however, that very large or heavy objects be carried on the roof while the vehicle is in motion. (See "Roof Loading" specifications in Miscellaneous section.)

Always have damage to the roof area repaired immediately. Damaged or detached sealant around the vents, air conditioner, body-to-roof seams, etc., should also receive immediate attention. Delaying these repairs may allow water leakage and result in damage to interior ceiling and body panels, upholstery, etc., which is not covered by the limited warranty (see Introduction section).

---

---

### UNDERBODY

Buildup of mud and dirt under the body can cause damaging rust on steel parts and can add needless weight to the vehicle. This, in effect, reduces the amount of cargo you can carry and remain within GVWR and GAWR limits.

Corrosive materials, such as those used for ice and snow removal and dust control, also accumulate on the underside of a vehicle. These materials should be removed by flushing the underbody regularly with water, especially areas where mud and other foreign materials collect.

---

---

## EXTERIOR FINISH

The exterior surface of your motor home has an automotive gel-coated fiberglass finish.

Follow these precautions to keep it looking its best and preserve maximum gloss and durability.

### Parking

- Avoid parking under trees. Rinse bird droppings and tree sap off as soon as possible. Lukewarm soapy water can help speed up the cleaning process.
- Avoid parking near ocean salt spray.
- Avoid parking near factories with heavy smoke or industrial fallout

### Driving

- Gravel roads should be avoided.
- Antifreeze, fuel, or window solution spilled on plastic surfaces, decals and appliques should be rinsed off immediately with water.
- Bugs and bird droppings should be rinsed off with water or washed with lukewarm soapy water daily.

### Washing

- Frequent washing and thorough cleaning is recommended to prevent damage to the finish from exposure to damaging salts, calcium chloride, road tar, tree sap, insects and other foreign material.
- Do not use strong soaps or detergents for washing the motor home.
- Wash with cool water out of direct sun light using a mild liquid soap (any 'no-tears' baby shampoo can be used). Never wash the vehicle in direct sunlight or while the vehicle surface is hot.
- Be careful when using pressure-type washers to avoid loosening exterior decals or sealants.

*NOTE: Avoid aiming water flow from a hose or spray from high pressure washing equipment into any appliance intake because damage or difficulty in operating appliances may occur.*

- Commercial vehicle wash facilities should be avoided. Revolving brushes, 'soaking' solutions and high pressure water spray may damage sealants, decals and appliques.
- Pressure-sensitive appliques or decals on your coach require very little maintenance, but should be treated like any painted surface on your vehicle. Wash with mild soap and water and rinse thoroughly. See "Care of Appliques and Decals" for details.
- After washing the coach, carefully inspect sealant around window frames and vents and any other joints that may have loosened or separated. See "Sealants" at the beginning of this section for details.



## CAUTION

Never use a strong solvent such as lacquer thinner, or harsh abrasives on plastics, decals and painted surfaces.

### Waxing and Polishing

When water will not bead up and roll off the finish of your freshly washed vehicle, a coat of automotive wax may be applied to the finish. Wax not only improves the appearance of the vehicle, but protects the finish against oxidation and corrosive substances.

We recommend using a wax that is compatible with painted and gel-coated fiberglass finishes.

If the finish begins to look dull or discolored, it may need to be cleaned with a polishing or cleaning compound formulated for gel-coated fiberglass finishes.

*NOTE: If you use a polish or a cleaning compound that does not contain a wax preservative, we recommend reapplying a coat of hard wax after cleaning or polishing the finish.*

### CARE OF APPLIQUES AND DECALS

The pressure-sensitive appliques and decals on your coach require very little maintenance. They should be treated like any painted surface on your vehicle.

Here are a few helpful hints on caring for decals:

- Wash appliques and decals with plain soap and water or any retail car wash soap. Always rinse thoroughly.
- High pressure water spray may loosen or damage appliques and decals.
- Test any cleaning solution on a small section of appliques or decal before using.
- Never use aromatic solvents such as acetone, MEK, toluene, xylene, lacquer thinner, etc., on appliques or decals. Any solvent including alcohol may soften or smear colors.
- Fuel or antifreeze spilled on appliques or decals should be rinsed off immediately with water.

### PLASTIC PARTS - CLEANING

Many parts in your motorhome, such as the dash, exterior light lenses, and certain exterior body panels are made of high-impact plastic materials that can be damaged by wiping with solvents or improper cleaning products.

Always try cleaning plastic parts with the mildest cleaners first and work your way up to stronger cleaning products. Use the following cautionary lists as a guide when selecting cleaning products to use on plastic parts.

CAUTION

**DO NOT use citrus based cleaners on polycarbonate finishes.**  
Citric compounds will damage the high-gloss surface, causing it to appear dull or 'flat'.  
Always test a cleaning product on a hidden area to be sure it will not cause damage to the appearance of the part.

Here is a list of mild cleaners that **may be used safely**:

- Car washing soap and water
- Glass cleaners *without ammonia*
- Mineral oil
- Multipurpose cleaners (such as Fantastik<sup>®</sup>, Formula 409<sup>®</sup>, etc.)

The following products, compounds or solvents must be **wiped off immediately** to avoid damage:

- Ammonia
- Brake fluid
- Bathroom basin, tub and tile cleaners
- Chlorine
- Ethyl alcohol
- Isopropyl (rubbing) alcohol
- Kerosene or gasoline
- Naphthalene
- 'Pine' type household cleaners

**Do not use** cleaners containing the following products, compounds or solvents. These products **will damage** the finish.

- Acetic acid
- Acetone (nail polish remover)
- Aromatic solvents (lacquer thinners)
- Benzene
- Butyl alcohol

---

---

## EXTERIOR LIGHTS

Most Winnebago Industries vehicles have polycarbonate lenses on exterior lamps, which are very sensitive to a variety of chemical solvents and cleaners.

Use only soap and water to clean exterior lamp lenses— especially headlights!

- Contact with certain chemicals can cause etching, ‘crazing’ or cracking of the lens, which can significantly reduce the lens clarity and effectiveness of the lamp and may require replacement of the complete lamp housing.
- Some popular citric acid cleaners may cause polycarbonate lenses to become ‘hazy’ or ‘foggy’.
- Do not use a pressure washer to clean headlights.
- Inspect and operate the lights regularly to confirm proper operation and mounting condition.

---

---

## INTERIOR SOFTGOODS

We recommend a weekly routine of vacuuming all fabrics and carpet throughout the motor home to prevent an accumulation of dirt which can detract from the appearance and shorten the life of carpet and fabrics.

### **Fabric Upholstery**

Some fabrics used in this motor home may contain fire retardant and fade resistant additives which can be damaged by use of improper cleaning products. Some water-based household cleaning products are not formulated for use on fabrics and may cause excessive shrinkage or fading. Always test any cleaning product on a hidden area of fabric before using on visible areas. For best results, fabric cleaning should be referred to a professional carpet and upholstery cleaner.

*NOTE: To minimize fading of upholstery, carpets and other interior fabrics caused by excessive sunlight, the drapes, blinds or*

*shades should be closed when the motor home is parked for an extended period of time.*



### **WARNING**

When cleaning upholstery and fabric, do not use lacquer thinner, nail polish remover, laundry soaps, or bleach. Never use carbon tetrachloride, gasoline, or naphthalene for any cleaning purpose. These materials may cause damage to the material being cleaned and most are highly flammable.

### **Vinyl Fabrics**

Vinyl should be cleaned with a soft, damp cloth, and a mild detergent only. Do not use solvents. Solvents may damage the surface of the vinyl.

### **Draperies, Curtains and Bedspreads**

These items may be woven from a variety of fabrics. We recommend that these be professionally dry cleaned only. A five percent shrinkage may occur when you have these items dry cleaned.

### **General Stains**

As with any stain or contamination, the quick response is the best, especially when done in conjunction with the proper cleaner for the type of stain.



### CEILING FABRIC CARE

While using your coach, your ceiling fabric may become soiled and require spot cleaning from time to time.

These materials are made from polypropylene or polyester synthetic fibers, so they clean very well with virtually no damage to the color or fabric itself.

Most commercially available carpet and upholstery cleaners will do an excellent job removing stains. From time to time, additional cleaning methods may need to be used to remove stubborn or difficult stains.

The following cleaning chart is provided as a guideline for care and cleaning of ceiling fabrics used in your coach.

Type of Stain	Cleaning Agent	How to Remove
Mustard	Dry-Clean Solvent	Scrub-Soak-Blot Dry
Ketchup*	High Strength Detergent	Scrub-Soak-Blot Dry
Coffee*	High Strength Detergent	Scrub-Soak-Blot Dry
Chocolate*	Detergent	Scrub-Soak-Blot Dry
Tea	High Strength Detergent	Scrub-Soak-Blot Dry
Chewing Gum	Dry-Clean Solvent	Scrub-Soak-Blot Dry
Oil	High Strength Detergent	Scrub-Soak-Blot Dry
Grease	High Strength Detergent/Degreaser	Scrub-Soak-Blot Dry
Tar/Asphalt	K-1 Kerosene/Thinner	Scrub-Soak-Blot Dry
Wax	Detergent	Hot Iron on Detergent-Soaked Towel/Cloth
Rust	Rust Remover	Scrub-Soak-Blot Dry
Dirt*	Detergent	Scrub-Soak-Blot Dry
Lipstick	Dry-Clean Solvent	Soak-Blot Dry
Nail Polish	Dry-Clean Solvent	Soak-Blot Dry
Shoe Polish	Dry-Clean Solvent	Soak-Blot Dry
Crayon	High Strength Detergent	Scrub-Soak-Blot Dry
Marker (indelible)	Detergent	Scrub-Soak-Blot Dry
Ink (Ballpoint Pen)	Dry-Clean Solvent	Soak-Blot Dry
Pencil Lead (Graphite)	Detergent	Scrub-Rinse-Blot Dry
Vomit*	High Strength Detergent	Scrub-Rinse-Blot Dry-Deodorize w/Vinegar
Urine*	High Strength Detergent	Scrub-Rinse-Blot Dry-Deodorize w/Vinegar
Blood*	High Strength Detergent	Scrub-Rinse-Blot Dry
Excrement*	High Strength Detergent	Scrub-Rinse-Blot Dry-Deodorize w/Vinegar

*NOTE: In many cases listed above, repeated steps may be required to fully extract contaminant from material. Items listed above with (\*) may also be removed through steam extraction method by a professional cleaner or service. Always check to see that the cleaner used will not cause damage to the material or fabric by testing on an area out of sight.*

### Water Stains

Water stains should be cleaned with a mixture of 1/4 cup of white powdered or clear liquid laundry detergent (no coloring) in a bucket of warm water. Working with a clean sponge or white cloth, start from the outside of the stain and

work your way to the center. This method will keep the stain from spreading. Do not over saturate as this may cause de-lamination. No need to scrub, simply rub lightly or dab the stain.

You may have to repeat this procedure more than once to achieve desired results. Finish up with clean water, using the same method, and blot dry.

Steam cleaning is also an option. Again, take care not to over-saturate the material.

*REMEMBER, this is polypropylene—basic plastic—so do not be afraid to clean it.*

---

---

### CABINETRY

Wooden items may be cleaned with a soft cloth and a good quality wood finish cleaning product.

Vinyl simulated wood panels may be cleaned with a mild, water based cleaner and a soft cloth. Do not use solvents on vinyl wood panels.

*NOTE: Many cabinetry and furniture items throughout this motor home are constructed either partially or completely of real hardwoods. Because of natural variations in woodgrain density, slight differences in stain hue may exist between one item and another. This is the distinctive character and beauty of real wood.*

---

---

### TABLES AND COUNTERTOPS

Work surfaces are covered with a plastic or thermo-formed laminate that resists solvents, stains and abrasions. A coat of furniture wax applied to these surfaces on the counters and table will help preserve their beauty and make cleaning easier. Always clean the surface before applying wax.

---

---

### GALLEY SINK

#### Stainless Steel

#### Care & Cleaning Instructions

The stainless steel sink can usually be cleaned with water and soap or detergent using a soft cloth or sponge.

- **Rinse thoroughly** with warm water and wipe dry quickly to avoid spots and streaks.
- **For stubborn stains**, use a mild abrasive cleanser like Soft Scrub<sup>®</sup>, Comet<sup>®</sup>, etc. Work in the direction of the 'grain' of the brushed finish lines.

- **Never use steel wool.** Particles of steel from the wool pad can embed into the sink surface, then become rusty and unsightly.
- **Avoid contact with full-strength** bleaches, household chemicals, and acid based cleaners. If this happens, rinse and wipe dry quickly.
- **Salt, mustard and mayonnaise** can cause pitting if left on the steel sink surface. If spilled, clean and rinse immediately.
- **A high iron content** in the water (hard water) may result in a brown or rust colored stained appearance. If noticed, dry towel sink after each use.
- **Do not use rubber mats** in the sink bowl. Material trapped under mats can complicate cleaning.

*NOTE: Improper use may damage this product and void the warranty.*



---

---

### RANGE AND REFRIGERATOR

For care and appearance maintenance of the range and refrigerator, refer to the operation and maintenance manual for each of the individual appliances included in your InfoCase.

---

---

### BATHROOM

#### Toilet

For instructions on the care of your toilet, refer to the information in your InfoCase.

## Tub and Shower Walls

The tub and shower walls in the bathroom should be cleaned with a mild soap and water solution. Do not use an abrasive cleaner on the shower door frame and towel bar, shower walls or tub.

## Lavatory Sink

The lavatory sink is made of the same material as the galley sink. See *Galley Sink - Care and Cleaning Instructions*.



---



---

## DOORS AND WINDOWS

Windows may be periodically cleaned with a good quality glass cleaner or mild soap solution using a soft cloth. Use care when removing ice or frost from the windows. Always use a plastic ice scraper, never one made of metal. Use care when removing ice from the mirrors to protect the reflective surfaces.

Door locks and hinges should be lubricated periodically with powdered graphite to ensure trouble-free operation and to protect against freeze-up.

---



---

## DAY/NIGHTER PLEATED BLINDS – CARE/ADJUSTMENT

### Tension Adjustment:

The tension of the pleated blinds can be adjusted if they become loose and will not stay up when raised, or they are too tight and are difficult to raise and lower.

### To tighten tension

Wrap the lower end of the guide cords (on each side of the shade) a few turns around the spools at the lower corners of the blinds.

### To loosen tension

Unwrap the guide cords from the spools one turn at a time until desired tension is achieved.

### Preserving Shape:

The pleated blinds are made using high quality materials that are designed and woven to retain their shape throughout their useful life. They may lose their crisp shape, however, if left in a lowered position for an extended period of time without being raised periodically. If this happens, the pleats can be restored using this simple method.

- With the blind fully lowered, dampen the entire area of the pleats with a good quality laundry spray starch.
- Raise the blind fully while still damp and let it remain in the raised position for about 24 hours.
- Reapply starch periodically (every few months) as needed.

---



---

## PREPARING VEHICLE FOR STORAGE

Properly preparing your vehicle for storage will lessen the possibility of damage to your vehicle. Prepare the motor home for vacancy just as you would if you were leaving your house for an extended period:

### Clean and Prep Coach for Storage

1. Turn off the propane gas tank
2. Turn the furnace thermostat switch OFF.

3. **Remove all foods and items that may cause odors from cabinets and refrigerator.**
4. Clean and defrost the refrigerator. Prop the door open slightly to allow any odors to dissipate. Place an open box of baking soda inside the refrigerator to help absorb odors.
5. **Fully charge the batteries. Batteries must have at least 80% charge to survive freezing temperatures and long period of non-use.** We recommend that you connect a battery charger or plug in the shoreline once a month during long-term storage periods to maintain battery charge and to avoid sulfating. If connecting a charger directly to batteries, turn the Aux Battery Switch off to avoid electrical arcing when attaching and detaching charge clamps.

*NOTE: We do not recommend leaving the shoreline plugged in continuously during storage periods because the batteries can lose electrolytic fluids and become damaged from continuous charging without periodic use. We recommend following regular battery inspection and maintenance especially in cold weather. See "Battery Care" in the Electrical section.*

6. After charging batteries, turn the Aux Battery Switch off to disconnect the batteries and avoid parasitic\* drain.  
  
*\* Parasitic battery drain is the gradual drain by items connected directly to battery power such as clocks, radio memory and the engine computer.*
7. Have the vehicle chassis completely serviced and lubricated. Be sure radiator antifreeze protection level is sufficient for the lowest anticipated temperatures.
8. Wash and wax the coach.
9. Inspect all seams and seals around doors, windows, vents, and any other joints. Replace or repair any that are damaged. Sealing materials and compounds can be purchased from your dealer. Badly damaged weather seals may need to be replaced by your dealer.

10. Close all windows and roof vents. Protect all appliance vent openings from contamination by animals or insects (e.g. bird nest, wasp nests, etc.)
11. Lubricate all door hinges and locks.
12. Clean the interior of the coach. Dirt and stains are more easily removed when fresh.

When storing your vehicle through the winter, or in cold climates, extra preparations need to be made to protect systems that can be damaged by freezing temperatures. See "Winterizing" in Plumbing Section.

---

---

## REMOVAL FROM STORAGE

1. Completely air out the motor home.
2. Have the entire LP gas system checked for leaks.
3. Check window operation.
4. Check cabinet and door hinges. Lubricate with penetrating oil, if necessary.
5. Close all faucets and drain valves that are open.
6. Add a few gallons of water to the fresh water tank and turn on the water pump to check for leaks especially at fittings.
7. Open all faucets in turn to release trapped air and check to be sure faucet washers have not hardened during storage.
8. Sanitize the water system as outlined under "Disinfecting the Fresh Water System" in the Plumbing Section, then flush the water lines thoroughly with fresh water.
9. Install a new water filter cartridge on the filtered water faucet if equipped. Store the diverter plug for future use – it is intended for winterization only.
10. Check the toilet for proper operation.
11. Add water to the holding tank using the toilet flush pedal and galley sink faucet. Check to be sure dump valves seal tightly.
12. Check around all appliances for obstructions and ensure that all vent openings are clear.
13. Start refrigerator and check for proper cooling.

14. Clean wall and counter surfaces.
15. Replace batteries if necessary and check out electrical system to make sure all lights and electrical components operate.
16. Check tires for proper cold inflation pressure. See Vehicle Certification Label.
17. After washing accumulated winter grime from the vehicle, it is important to carefully inspect the seams and sealants for separation or cracks that may have appeared around the window frames, vents and any other joints. See “Sealants” at the beginning of this section.  
Re-sealing is quite simple and the material is quickly and easily applied. Appropriate compounds are available from your dealer. See “Recommended Sealant Application” page at the end of this section.  
Also inspect weather seals around doors, etc., and if necessary, have a dealer replace immediately.

### **Ice Maker Start-Up –If Equipped**

1. Close all drain valves.
2. Turn the water supply on.
3. Be sure the ice bin is in place and the automatic shutoff arm is down.
4. Let the refrigerator cool down to ice making temperature. Remember, this can take up to 24 hours.
5. Let the ice maker cycle and dump the first batch of ice.

**COACH MAINTENANCE CHART**

These recommendations apply for normal recreational use. Heavy duty or full-time use may require more frequent maintenance intervals.

Always use specified sections or manufacturer's guide for further information and instructions.	Before Each Use	Weekly	Monthly	Every 3 Months	Every 6 Months	Every Year	As Necessary
<b>Propane Gas System</b>							
Have propane gas system checked for leaks.						◆	◆
Pressure regulator - inspect and adjust if needed						◆	
Check propane tank condition, mounting and fittings						◆	
<b>Electrical System</b>							
Check Battery Condition Meter	◆						
Check battery fluid level & connections			◆				
Check 12V fuses & 120V breakers							◆
Check GFCI Receptacles			◆				
<b>Generator</b>							
Visually inspect Generator and Compartment	◆						
See generator manufacturer's maintenance guide							◆
<b>Plumbing System</b>							
Sanitize plumbing system							◆
Winterize plumbing system							◆
Clean water pump strainer filter						◆	◆
<b>Slide-Out &amp; Leveling System</b>							
Check Hydraulic Oil Level			◆				◆
Check Hydraulic Lines (routing, leaks, etc.)						◆	
Check & inspect room seals (bulb seals)					◆		◆
<b>Exterior</b>							
Clean roof				◆			◆
Clean sidewalls			◆				◆
Clean windows							◆
Flush underside of vehicle				◆			◆

## COACH MAINTENANCE CHART

These recommendations apply for normal recreational use. Heavy duty or full-time use may require more frequent maintenance intervals.

Always use specified sections or manufacturer's guide for further information and instructions.	Before Each Use	Weekly	Monthly	Every 3 Months	Every 6 Months	Every Year	As Necessary
<b>Safety Equipment</b>							
Check operation of the following items							
Headlights, Taillights and Marker Lights	◆		◆				
Turn Signals	◆		◆				
Horn	◆		◆				
Hazard Warning Flashers	◆		◆				
Windshield Wipers & Washers	◆		◆				
Fire Extinguisher - check charge indicator	◆		◆				
Smoke Alarm - test operation *	◆		◆				
Carbon Monoxide Alarm - test operation *	◆		◆				
Propane Gas Leak Detector - test operation (*replace battery if needed)	◆		◆				
<b>Appliances</b>							
<b>Water Heater</b>							
See water heater manufacturer's maintenance guide							◆
Inspect & clean exterior vent	◆						◆
<b>Refrigerator</b>							
Refrigerator maintenance guide							◆
Inspect and clean exterior vent & drip tray drain tube	◆						◆
<b>Furnace</b>							
See furnace manufacturer's maintenance guide							◆
Inspect & clean exterior vent	◆						◆
<b>Air Conditioner</b>							
See A/C manufacturer's maintenance guide							◆
Inspect for exterior damage				◆			◆
Check/Replace Filter			◆				
<b>Range Top</b>							
See range manufacturer's maintenance guide							◆
Inspect & clean/replace range hood grease filter							◆

**COACH MAINTENANCE CHART**

These recommendations apply for normal recreational use. Heavy duty or full-time use may require more frequent maintenance intervals.

Always use specified sections or manufacturer's guide for further information and instructions.	Before Each Use	Weekly	Monthly	Every 3 Months	Every 6 Months	Every Year	As Necessary
<b>Sealants</b>							
Inspect (see "Sealants" at the beginning of this section for proper inspection technique)					◆		◆
Replace (see "Recommended Sealant Application" page at the end of this section)							◆
<b>Frame &amp; Chassis</b>							
Follow chassis manufacturer's maintenance guide (refer to chassis manual)							◆
Inspect Hitch Receiver (if towing)	◆						
<b>Tires</b>							
Check & adjust air pressure	◆						◆
Check tread wear	◆						◆
Check front end alignment and adjust if needed							◆
<b>Miscellaneous</b>							
Lubricate locks, hinges, latches						◆	◆



### RECOMMENDED SEALANT APPLICATION

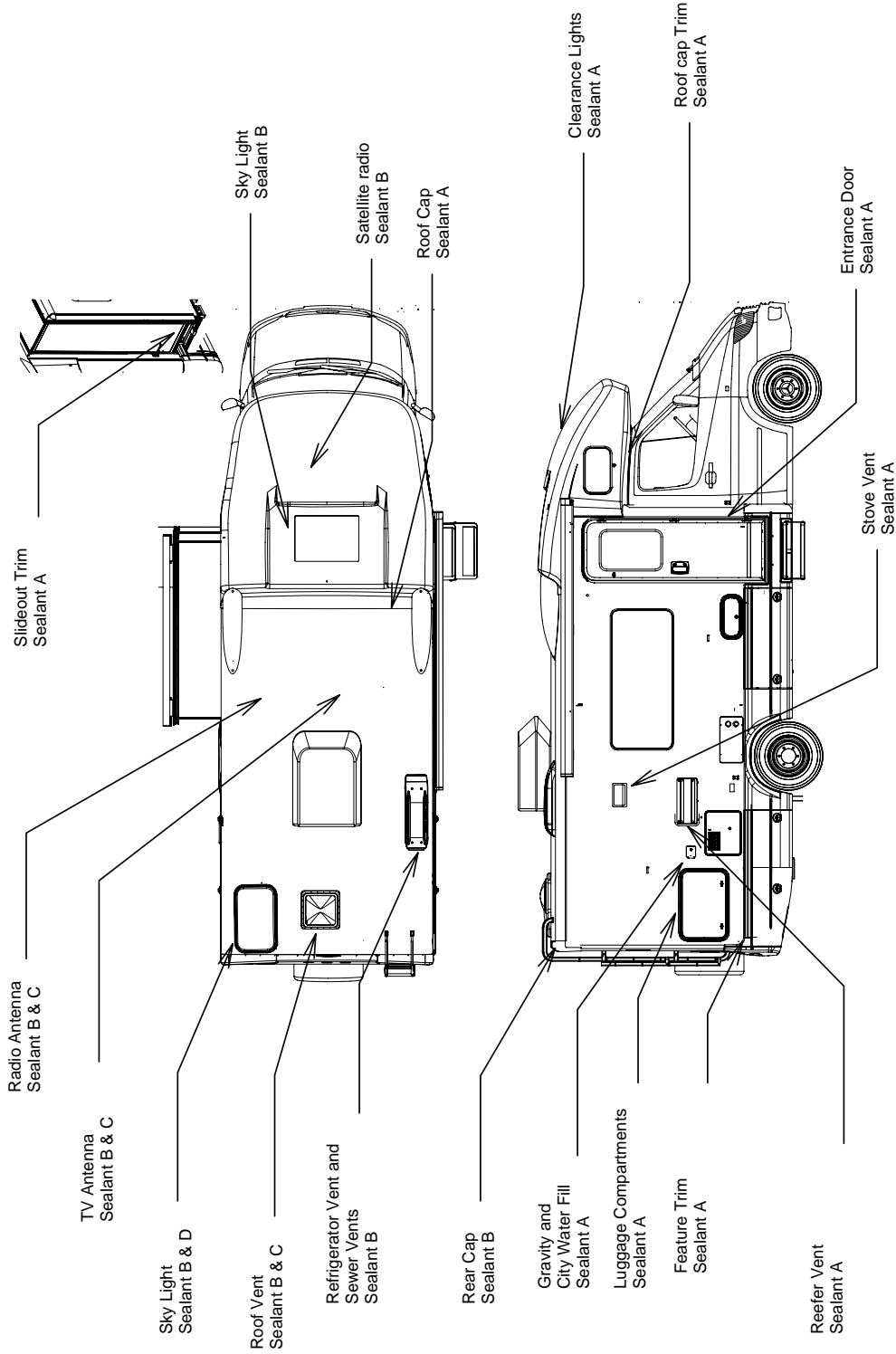

**Sealants may be purchased from your Winnebago or Itasca Dealer**

Note: Sealant 131264-03-02A may be substituted for Sealant B.

This is only a graphic representation for sealants and does not represent actual component position.  
Rev A

Sealant	Winnebago Part #
A	072889-10-000
B	131264-03-01A
C	131264-05-02A
D	131264-04-02A



## SECTION 12 - MISCELLANEOUS

---

---

---

### LOADING THE VEHICLE

*NOTE: Your motor home's load capacity is designated by weight, not by volume, so you cannot necessarily use all available space when loading your motor home.*

- Store or secure all loose items inside the motor home before traveling. Possible over-looked items such as canned goods or small appliances on the countertop, cooking pans on the range, or free-standing furniture items can become dangerous projectiles during a sudden stop or evasive maneuver.
- Be aware of GVWR, GAWR and individual load limit on each tire or set of duals.

When loading the vehicle, distribute the cargo load equally so that you do not exceed either the Front or Rear Gross Axle Weight Rating (GAWR) or the Gross Vehicle Weight Rating (GVWR). The Gross Axle Weight Rating (GAWR) means the weight value specified by the chassis manufacturer as the load carrying capacity of a single axle system as measured at the tire-to-ground interfaces. This is the total weight a given axle is capable of carrying. Each axle has its own rating.

Have your vehicle weighed to determine the proper load distribution for your vehicle. Also distribute cargo side-to-side so the weight on each tire or dual set does not exceed one half of the GAWR for either axle.

For example, if the Front GAWR is 6,000 lbs., there should be no more than 3,000 lbs. on each tire. (If the left side weighs 3,100 lbs. and the right side weighs 2,700 lbs., at least 100 lbs. of the load must be shifted from the left side to the right side.) The GVWR is listed on the Vehicle Certification Label. (See sample in Specifications Section).

The GCWR (Gross Combination Weight Rating) means the maximum allowable loaded weight of this motor home and any towed trailer or towed vehicle.

*NOTE: We recommend that you dump all holding tanks before traveling to avoid carrying unnecessary weight.*

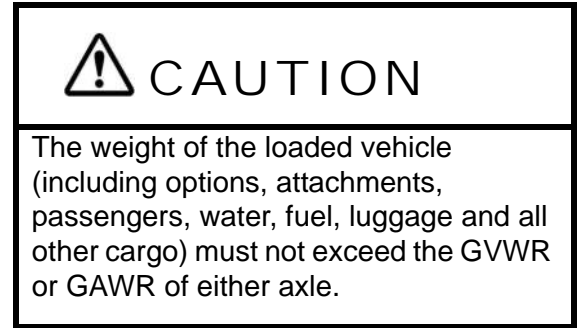

---

---

### ROOF LOADING

The roof is capable of carrying up to 10 pounds per square foot to a maximum of 100 pounds while the vehicle is in motion.

When the vehicle is stationary, a cargo load of 100 pounds plus the weight of a 225 pound person to load the cargo or to conduct inspection and maintenance is permissible.

Weight added to both the roof and the trailer hitch contribute to the gross vehicle weight, which must not exceed the vehicle's GVWR.

---

---

### WEIGHING YOUR LOADED VEHICLE

To check the weight of your fully loaded coach, locate a commercial weighing scale that is capable of weighing large trucks.

*NOTE: Sales literature may give approximate or standard weights. Your actual coach weight may differ based on added factory and/or dealer options.*

### Loading

Load your vehicle completely as if you were going on a long trip, with everything you would carry, including food, clothing, bedding, lawn

chairs, etc., a full fuel tank, full propane tank, and a partial tank of fresh water - but empty holding tanks.

### Finding a Scale

In urban areas, the most common places to find a public access scale are commercial truck stops. In rural areas, most grain storage elevators have scales available. Most scales charge a nominal fee for weighing a vehicle.

### Weighing

There is typically a scale operator to direct you but the basic routine is to take three separate weights - front axle, whole vehicle, and rear axle.

You will first drive only your front wheels onto the scale pad, then drive ahead so that the whole vehicle is on the scale, then finally pull off until just the rear wheels are on the pad.

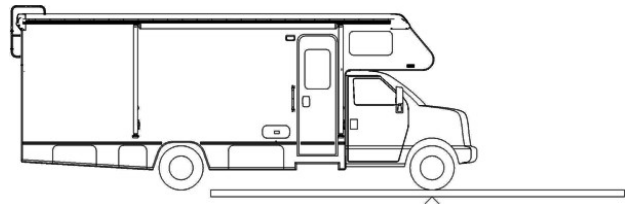

Front GAWR (Front Axle Only)

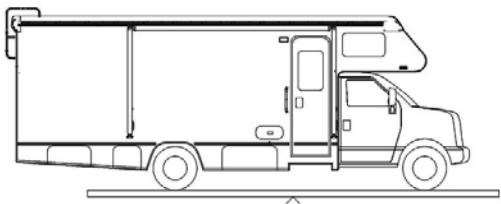

GVWR - Whole Vehicle (All Axles)

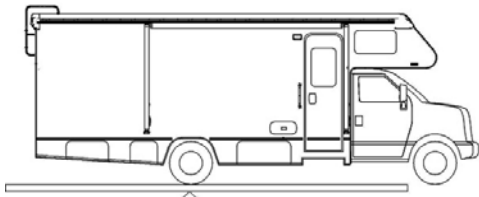

Rear GAWR (Rear Axle Only)

You will receive a weight ‘ticket’ that states your current Front Gross Axle Weight, Rear Gross Axle Weight and Gross Vehicle Weight. You can compare these weights to the weight ratings listed on your Vehicle Certification Label to use as a guideline for future loading limits and weight distribution.

The gross weight of the vehicle must not exceed the Gross Vehicle Weight Rating (GVWR) specified on the Vehicle Certification Label. The front and rear axle weight also should not exceed the corresponding Axle Weight Rating specified on the Vehicle Certification Label.

### Corner Weighing (Side-to-Side)

The most accurate method of weighing a motorhome is to weigh each ‘corner’ of the coach separately (single L/R front wheels or L/R rear dual sets). This method will help you determine how to distribute your cargo to avoid overloading, especially on tires.

To determine the weight distribution on each tire or dual set, you will need to find a scale capable weighing side-to-side, or all four ‘corners’ of the vehicle, separately.

A truck scale may be used if the ground is level with the scale surface and the scale has clearance to drive one side of the coach onto the scale as shown.

Drive the coach on the level area next to the scale and straddle the scale so that only one side of the coach will be on the scale pad.

*NOTE: Wind and precipitation can also cause weight inaccuracies.*

Pull only the right front wheel onto the scale pad as shown.

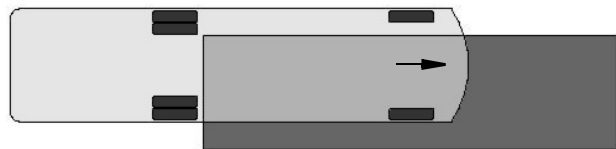

Weighing Right Front Corner

When the front wheel has been weighed, pull the coach straight ahead until only the right rear wheel/dual set is on the scale pad as shown.

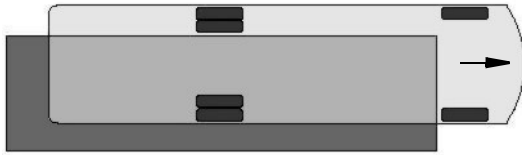

Weighing Right Rear Corner

Now, turn the coach around and repeat the process for the other side.

The load on each wheel or dual-wheel set should not exceed one-half of the corresponding GAWR. For example, if the GAWR for the rear axle is 12,000 lbs., then the load on each rear dual set (left rear duals or right rear duals) should not exceed 6,000 lbs.

Tires must be filled to the recommended air pressure for the highest loaded tire set on that axle. For example, on the rear axle, if the left side weighs more than the right, fill the left tires to the pressure required for that weight, then fill the right tires to the same pressure as the left ones.

If your actual weight is considerably less than GAWR, you may be able to lower your tire pressure. See a tire dealer for a load/pressure chart.

*NOTE: The Hitch Load from a Towed Vehicle or carrier box must also be counted on the Rear GAWR and subtracted from the rear axle cargo capacity.*

Be aware that hitch load can affect handling characteristics. The more weight on the hitch, the lighter the front end will feel at the steering wheel.

## CAR OR TRAILER TOWING

### Hitch pulling capacity:

**3,500 lbs. max.**

### Tongue weight

**350 lbs. max.**

The factory installed towing hitch on this coach is capable of pulling 3,500 lbs. load (max.), however the vertical (tongue) weight may vary according to chassis and model combinations. Do not exceed either the GVWR, the rear axle GAWR, or the chassis GCWR by the combined loaded weight of the coach and the towed vehicle. See preceding items "Loading the Vehicle" and "Weighing Your Loaded Vehicle" for explanation of weight ratings.

Because of individual vehicle use and loading habits, we recommend weighing the vehicle while fully loaded to avoid exceeding any of the listed Gross Weight Ratings. See "Vehicle Certification Label" in the Introduction Section for information on gross weight ratings.

Towing will affect vehicle handling, durability and fuel economy. Exceeding any of the listed Gross Weight Ratings will result in unacceptable overall vehicle performance. Maximum safety and satisfaction when towing depends on proper use of correct equipment. Select a drawbar that mates properly with the towing hitch receiver and provides proper alignment to the vehicle tow bar. The tongue of the tow bar must be as close as possible to parallel with the ground when attached to the hitch ball.

Installation of a proper trailer brake system is recommended. Check state regulations on trailer weight and trailer brake requirements to be sure you select the right equipment before towing.

Before descending a steep or long grade when towing a trailer, reduce speed and shift into a lower gear to control vehicle speed. Avoid prolonged or frequent application of brakes which could cause overheating and brake failure.

## WARNING

For safe towing and vehicle handling, maintain proper trailer weight distribution. The total weight of the motor home and the vehicle towed must not exceed the Gross Combined Vehicle Weight rating. See the “Body and Chassis Specification” chart in the Introduction Section.

## CAUTION

Exceeding any of the recommended gross vehicle weight ratings may result in vehicle damage. Do not install a frame equalizing type hitch on your vehicle.

---



---

## TRAILER WIRING CONNECTOR

Your coach is pre-wired for trailer or car towing lights with a 6-pin socket on the rear bumper. The connector plug is supplied in the coach parts package provided to you by your dealer when you took delivery of the vehicle.

The diagram shows proper connection of trailer or tow vehicle wiring to the coach light system. We recommend connections be made by a qualified auto electrical technician to avoid ‘shorts’ or other malfunctions.

- TM = Tail lights
- GD = Ground
- LT = Left turn
- RT = Right turn
- A = Backup lights
- S = Brake lights

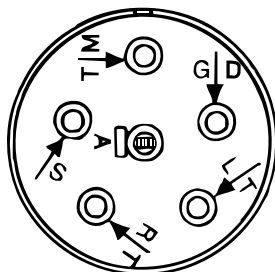

---



---

## TOWING GUIDELINES

### Gross Vehicle Weight Rating (GVWR):

This is the maximum allowable weight of the fully loaded vehicle. Included are fuel, water, propane, passengers, cargo, tools, and optional equipment installed by the motor home manufacturer, dealer, or owner. This value is found on the Vehicle Certification Label.

### Gross Axle Weight Rating (GAWR):

This is the total weight a given axle is capable of carrying, measured at the ground. Each axle has its own rating. These values are also found on the Vehicle Certification Label: front, rear, and tag, if applicable.

### Gross Combination Weight Rating (GCWR):

This is the maximum allowable weight of the motor home and loaded trailer, including the items noted in GVWR above. The “trailer” can be an actual trailer, a vehicle towed on a towing dolly, or a vehicle towed by means of a towing bar. GCWR is typically specified based on durability and performance of the tow vehicle drivetrain: engine cooling systems, transmission, drive line, drive axle, and others. The tow vehicle brakes may be rated for operation at GVWR, not GCWR.

*NOTE: If the “trailer” weighs 1,000 lbs. or more, state or provincial laws/regulations may require the “trailer” to be equipped with brakes that are activated when the motor home brakes are applied. **The user is responsible to know and understand the laws of the state or province being traveled.** The Department of Transportation in a given state or province should be able to provide specific information.*

### Hitch Ratings:

SAE Standard J684 defines:

- Class 1 trailers as “GVWR not to exceed 2,000 lbs.”
- Class 2 trailers as “GVWR over 2,000 lbs. and not to exceed 3,500 lbs. GVWR”
- Class 3 trailers as “GVWR over 3,500 lbs. and not to exceed 5,000 lbs. GVWR”
- Class 4 trailers as “GVWR over 5,000 lbs. and not to exceed 10,000 lbs. GVWR”

Hitches are to be permanently marked with “Maximum trailer GVWR to be drawn” and “Maximum vertical tongue weight to be imposed...” The SAE standard does not specify a vertical load rating, as such. Traditionally, hitches are labeled 3,500/350 as Class 2 and 5,000/500 as Class 3.

The vertical tongue load value of 10 percent of drawn rating apparently comes from the collective experience that 10 percent is the minimum value that provides stable towing of a trailer. Ford’s towing guide suggests 10 to 15 percent for trailers over 2,000 lbs. (Hitch ratings are independent of towing vehicle ratings.)

*NOTE: All Winnebago Industries models equipped with a Class 4 hitch have a label stating vertical tongue load is limited to 500 lbs.*

The user must verify that the hitch equipment being used is adequate for the application.

### ELECTRIC ENTRANCE STEP -If Equipped

The power switch for the electric entrance step is located to the left of the main entry door as you enter the coach.

WARNING

Do not use step unless fully extended.  
Do Not Stand on step when vehicle ignition switch is turned to either the “On” or “Start” position.  
The step will automatically retract, which may cause personal injury.

### Automatic Mode - Entry Step Switch ON (Step Operates with Door)

With the Step switch in the ON position the step is in Automatic Mode. This means it will extend and retract automatically whenever the screen door is opened or closed.

### Stationary Extended Mode - Step Switch OFF (Step Remains Extended)

With the Step power switch in the OFF position the step will extend when the screen door is opened and will stay extended whether the door is opened or closed.

This position is normally used to keep the step extended when parked at a campsite or whenever people will be entering and exiting the vehicle frequently.

### Automatic Retraction Feature

The step is equipped with an automatic retraction feature that stores the step automatically when the Ignition Switch key is turned to the On or Start positions and the entrance door is closed.

The step will retract regardless if the Step power switch is ON or OFF.

This feature is intended to prevent injury or damage by an extended step while the vehicle is moving.

### Further Information

For additional information on the step, see the manufacturer’s operators manual included in your InfoCase.

### OVERHEAD READING LIGHT SWITCH

#### -If Equipped

Your coach may be equipped with an overhead reading light switch located on the front bunk that when the bunk is in the raised position, it deactivates the reading light. The bunk must be in the down position for the reading light to work.

---

---

**WINDOWS**

**Crank-Out Windows**

Turn the crank-out knob clockwise to open window; counterclockwise to close. Do not use excessive force on the knob to open or lock into closed position. This could cause permanent damage to the crank mechanism.

When closing the window, crank the window in snugly, then back off 1/4 turn to help avoid glass warping which can result in wind noise.



If the window will not open after three or more full turns of the knob, the glass may be stuck to the sealing gasket. Go to the outside of the coach and gently free the glass with your fingers. A periodic light dusting of talcum powder on the gasket should prevent this from recurring.

**Horizontal Slider Windows**

Swing the latch handle straight out from the window. Grasp the sliding window edge frame and slide the window to the side. Be sure the latch is open before trying to slide the window closed.



**Vertical Slider Windows**

Vertical windows have spring-loaded catches on both sides of the window that pop out to hold the window in its fully raised position. Press the catches outward toward the frames while lowering the window.

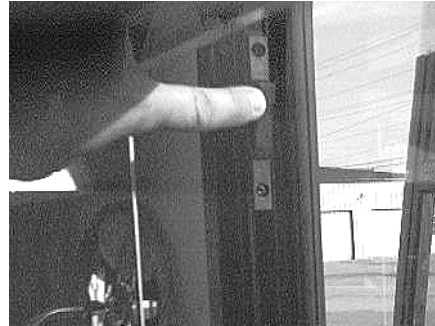

Vertical Window Catches

---

---

**SKYLIGHT**

The skylight contains a sliding shade for privacy and light control and a screen, both of which retract into the sides. It can also be opened to several positions for ventilation if necessary.

Press the large latch button with your thumb and pull the lever down as shown in the following photos.







 <b>CAUTION</b>
<p>Always close the skylight completely before driving. Do not open the skylight when the vehicle is in motion.</p>

### POWER ROOF VENTILATOR Lounge, Galley or Bath Area -If Equipped

The vent dome is raised and lowered using the Dome Crank knob on the fan.

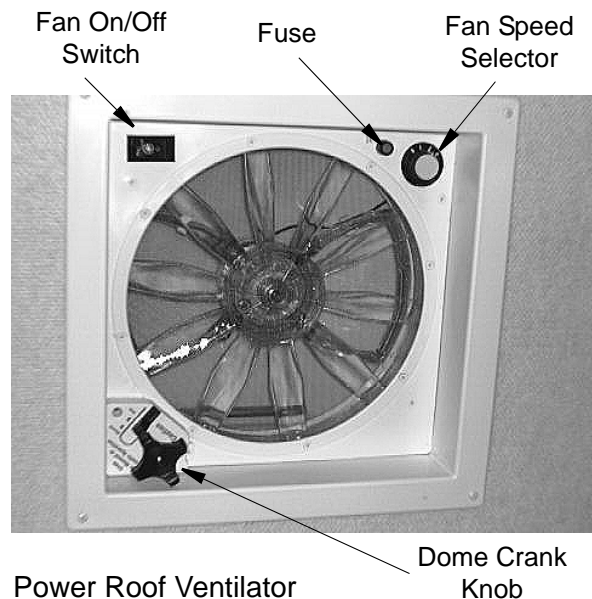

### To Operate Ceiling Ventilator

1. Turn the Dome Crank Knob to raise the dome about 3" or more to allow the turbine fan to operate. (A built-in safety switch will not allow fan motor to run unless dome is partially open.)
2. Turn the Fan Speed knob to the desired level (0-Off 1-Low 2-Med 3-Hi)
3. Open a window or door to provide airflow. Direction of airflow is determined by which window or door is opened.

*NOTE: For best results, close all other roof vents, windows and doors, then open one (1) window the farthest distance from the roof ventilator. The fan speed selector on the fan allows you to adjust the amount of circulation you need at any time.*

4. The Fan On/Off switch lets you turn the fan off if you want the vent dome raised without the fan running.
5. If the Fan On/Off switch is in the ON position, the turbine fan will start automatically as the vent dome is raised and stop as the vent dome is lowered and closed.

### Further Information

See the power vent manufacturer's operating instructions supplied in your InfoCase for further instructions, care and cleaning information.

---

---

**ROOF LADDER**

**-If Equipped**

The ladder provided on your motor home is for limited access to the roof of your coach. If you are working on your roof, create an environment that provides safety as a first priority.

**Before Using the Ladder**

- **Inspect the ladder** to make sure it is not damaged. Never use a damaged ladder.
- **Keep the rungs of the ladder clean and dry** while in use. Never use the ladder when it is raining, snowing or icy. The rungs can become slippery. Do not step onto the rungs if the rungs are wet, or if your shoes are wet or carry mud or debris that could result in a loss of footing.
- **Never ignore warning labels** or weight limits defined on your ladder. The following warning label is located on or near the ladder:

<p> <b>WARNING</b></p> <p>Do not exceed 225 lbs. maximum weight capacity. Misuse of ladder could result in death or serious injury. See Operators Manual before using ladder.</p>
--

- **Maximum Capacity: 225 lbs.**
- **Do not overload.** Ladder is intended for one person.
- **Make sure you are physically capable** to safely use the ladder. Strength, flexibility and stability are required.
- **Be aware that the vehicle may sway** as you climb the ladder. Do not use the ladder in high winds.
- **As you climb the ladder,** grasp the side rails firmly and always use both hands. Keep your body centered between the side rails. Do not over-reach.
- **Always store** the ladder extension when not in use.
- **Never allow children** on the ladder.
- **Do not transport items** anchored to the ladder. You could damage the ladder.

**To Use the Ladder Extension:**



- Pull the retainer pin and lower the ladder into position as shown.

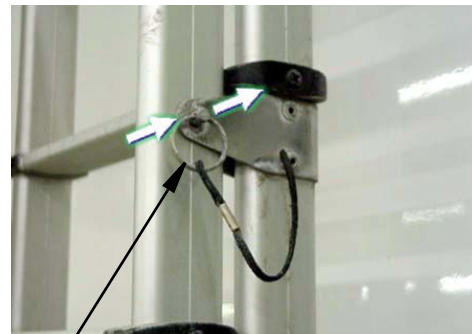

Pull pin to lower ladder extension



- Make sure ladder is resting squarely and firmly on ground before using.
- Fold the extension upward and reinsert the pin to store.
- Be sure latch is fastened securely to prevent ladder from dropping while the coach is in motion.

### AWNING & DOOR PROPS

When you are using the awning with the arm-to-wall attachments, the door can contact the awning arms when opened.

- To open the door fully, you must extend the awning and position the lower arms vertically, like tent canopy poles. Fully extend the lower arms and stake to the ground.
- To avoid damaging the door when the awning arms are attached to the vehicle, we have provided a prop rod to be used to hold the door in an open position.



Awning Arms Door Prop



Insert ends of door prop into loop brackets on sidewall and door to provide adequate door clearance and avoid contact with awning arm.

- After setting the awning, **crank awning about 10 turns inward** to raise the canopy slightly to provide adequate door clearance and avoid abrasion on the awning.

### Door Prop and Awning Hook Storage Locations

**Model 24B:** Right rear exterior storage compartment (beneath bunk)

**Model 24H:** Beneath sofa

**Model 24J:** Right rear exterior storage compartment (beneath bed)

### Further Information

See the awning manufacturer's information in your InfoCase.

### EFFECTS OF PROLONGED OCCUPANCY

Your motor home was designed primarily for recreational use and short term occupancy. If you expect to occupy your coach for an extended period, be prepared to deal with condensation and humid conditions that may be encountered.

### Humidity and Condensation

Moisture condensing on the inside of windows is a visible indication that there is too much humidity inside the coach. Excessive moisture can cause water stains or mildew which can damage interior items such as upholstery and cabinets.

When you recognize the signs of excessive moisture and condensation in your coach, you should take immediate action to minimize their effects.

You can help reduce excessive moisture inside the motor home by taking the following steps:

#### Ventilate with outside air:

Partially open one or more windows and a roof vent to circulate outside air through the coach. In cold weather, this ventilation may increase use of the furnace, but it will greatly reduce the condensation inside the coach.

**Minimize moisture released inside the coach:**

Run the range hood fan while cooking, and open a bath vent while bathing or showering to carry water vapor out of the coach. Avoid making steam from boiling water excessively or letting hot water run. Avoid bringing extra moisture into the coach by way of soaked clothing or snow on shoes. Do not hang-dry wet overcoats or clothing inside the coach.

# Navion

## INDEX

---

120-Volt AC System .....	6-1	Electrical Generator .....	6-5
120-Volt Circuit Breakers .....	6-4	Emergency Exits .....	2-4
120-Volt Receptacles (Outlets) .....	6-4	Emergency Information .....	1-6
12-Volt DC System .....	6-6	Engine Cooling System .....	3-5
12-Volt House Fuses and Circuit Breakers ..	6-9	Engine Overheat .....	2-8
2007 New Vehicle Limited Warranty .....	1-7	Exterior Finish .....	11-2
About this Manual .....	1-1	Exterior Lights .....	11-4
Air Conditioner Filter .....	4-9	Exterior Shower / Wash Station .....	7-5
Audio-Video System Basic Operation .....	8-1	External Power Cord .....	6-1
Auto Air Conditioner/Heater .....	3-3	Fire Extinguisher .....	2-3
Automatic Door Re-lock Feature .....	3-3	Formaldehyde Information .....	2-5
Auxiliary Battery Disconnect Switch .....	6-7	Fresh Water System .....	7-1
Awning & Door Props .....	12-9	Front Axle Tire Alignment .....	1-2
Bathroom .....	11-6	Front Bunk .....	9-1
Battery Boost Switch .....	3-4	Front Seats .....	3-1
Battery Care .....	6-7	Furnace-A/C Thermostat Operation Chart	4-10
Cabinetry .....	11-6	Galley Sink .....	11-6
Cable TV Hook-Up .....	8-4	General Slideout Care .....	10-3
Car or Trailer Towing .....	12-3	General Warnings .....	2-1
Carbon Monoxide Alarm .....	2-2	Ground Fault Circuit Interrupter .....	6-4
Carbon Monoxide Warning .....	2-2	Hazard Warning Flashers .....	3-3
Care of Appliques and Decals .....	11-3	Heat Pump .....	4-8
Ceiling Fabric Care .....	11-5	Holding Tank Heater .....	7-7
Child Restraints .....	3-2	House Battery Access .....	6-7
Coach Maintenance Chart .....	11-10	In-Dash Radio .....	3-4
Couch/Bed Conversion .....	9-2	Interior Softgoods .....	11-4
Dash Radio through Deluxe Sound Speakers	8-3	Jump Starting .....	2-8
Day/Nighter Pleated Blinds –		Keys .....	3-2
Care/Adjustment .....	11-7	Lights .....	3-5
Day/Nighter Pleated Blinds .....	9-4	Loading the Vehicle .....	12-1
Dinette/Bed Conversion .....	9-3	Microwave Oven .....	4-3
Disinfecting Your Fresh Water System .....	7-3	Mold, Moisture and Your Motor Home .....	2-5
Doors and Windows .....	11-7	Motor Aid Water Heater .....	4-6
Driving Safety .....	2-1	Mountain Driving .....	3-6
Ducted Roof Air Conditioning System .....	4-9	Overhead Reading Light Switch .....	12-5
DVD Player with Deluxe Sound .....	8-2	Owner Information .....	1-6
Effects of Prolonged Occupancy .....	12-9	Plastic Parts - Cleaning .....	11-3
Electric Entrance Step .....	12-5	Power Center .....	6-3
Electrical Cautions .....	6-1	Power Roof Ventilator .....	12-7

---

---

Pre-Delivery Inspection .....	1-2	Tires .....	3-5
Preparing Vehicle for Storage .....	11-7	Toilet .....	7-5
Pressure-Temperature Relief Valve .....	4-6	Towing Guidelines .....	12-4
Propane Gas Furnace .....	4-7	Trailer Wiring Connector .....	12-4
Propane Gas Leak Detector .....	2-1	TV – 12-Volt LCD .....	8-1
Propane Gas Pressure Regulator .....	5-4	TV Satellite System Wiring .....	8-5
Propane Gas Supply .....	5-1	TV Sound through Deluxe Speakers .....	8-3
Propane Gas Warnings and Precautions .....	5-3	Underbody .....	11-1
Propane Vaporization in Cold Weather .....	5-5	Waste Water System .....	7-5
Range and Refrigerator .....	11-6	Water Heater – Gas .....	4-5
Range Hood .....	4-3	Water Heater - Gas/ Electric .....	4-5
Range Top .....	4-2	Water Heater Bypass Winterization Valve ..	7-8
Rear Auxiliary Air Springs .....	3-6	Water Line and Tank Drain Valves .....	7-7
Rear Bunk .....	9-2	Water Pump .....	7-2
Rearview Monitor System .....	3-3	Water System Drain Valve Locations .....	7-14
Recommended Sealant Application .....	11-13	Weighing Your Loaded Vehicle .....	12-1
Refrigerator .....	4-1	Wheel Mounting Nuts (Lug Nuts) .....	2-7
Refrigerator Service Access Compartment ..	4-2	Windows .....	12-6
Remote Keyless Entry .....	3-3	Wood Furniture and Cabinetry .....	9-4
Removal from Storage .....	11-8		
Reporting Safety Defects .....	1-2		
Roadside Emergency .....	2-6		
Roof .....	11-1		
Roof Ladder .....	12-8		
Roof Loading .....	12-1		
Safe Use of the Propane Gas System .....	5-2		
Safety Messages Used in this Manual .....	1-1		
Sealants .....	11-1		
Seat Belts .....	3-1		
Service and Assistance .....	1-2		
Shower Hose Vacuum Breaker .....	7-5		
Skylight .....	12-6		
Sleeping Facilities .....	9-1		
Slideout Emergency Retraction .....	10-3		
Slideout Room –			
Extreme Weather Precaution .....	10-3		
Slideout Room Operation – Electric .....	10-1		
Smoke Alarm .....	2-3		
Specifications and Capacities .....	1-4		
Suspension Alignment and Tire Balance .....	3-5		
Systems Monitor Panel .....	4-3		
Tables and Countertops .....	11-6		

---